



Meridian 1 and Succession Communication Server for Enterprise 1000
i2004 Internet Telephone User Guide



Revision History

November 2002

Standard 2.00. This document is up-issued to support Meridian 1 Release 25.40 and Succession Communication Server for Enterprise 1000, Release 2.0.

June 2001

Standard 1.00.

i2004 Internet Telephone	6
i2004 Internet Telephone features	6
Telephone Controls	7
i2004 Internet Telephone display	11
Install your i2004 Internet Telephone	12
Your i2004 Telephone Option Menu	14
Adjust volume	15
Adjust Screen contrast.....	17
Select a language.....	18
Select Date/Time format.....	18
Display diagnostics.....	19
Local Dialpad Tone.....	19
Choose Ring type	20
Enable Call timer.....	20
Enable OnHook Default Path	21
Change Feature Key Label.....	21
Set Information.....	23
Call features	24
Make a call	25
Make a call while on-hook	25
Make a call while off-hook	25
Use Handsfree calling	26
Use the Corporate Directory	27
Use Predial	29
Use Auto Dial.....	30
Activate Ring Again.....	31
Redial last number called	32
Use Speed Call.....	32
Make a System Speed Call.....	33
Use Hot Line.....	33

Make an Intercom call	34
-----------------------------	----

Answer a call **35**

While on an active call **36**

Place a call on hold	36
Transfer a call	36
Use Timed Reminder Recall	37
Use Attendant Recall	38
Use Call Park.....	38
Record a Calling Party Number	40
Display incoming calls.....	40
Trace a Malicious call	41

Incoming calls **42**

Activate Automatic Answerback.....	42
Activate Call Pickup	42
Use Call Waiting	43

While you are away from your desk **45**

Use Call Forward.....	45
Use Internal Call Forward	46
Use Remote Call Forward	47
Secure your telephone.....	48

Talk with more than one person **50**

Use the Call Join feature.....	50
Set up a Conference call.....	50
Use the Conferee selectable display and disconnect feature.....	51
Use Group Call	52

Work without interruption **54**

Activate Make Set Busy	54
------------------------------	----

Additional Call Features	55
Auto Dial Transfer Feature.....	55
Use the Buzz signal	55
Use Call Page Connect to make an announcement	56
Use Centrex/Exchange Switchhook Flash	56
Charge a call or Charge a Forced call	57
Use Enhanced Override Feature	59
Use Forced Camp-on feature	59
Override a busy signal.....	60
Use Privacy Release	61
Use Radio Page.....	61
Use Voice Call.....	63

Additional Features	64
Virtual Office	64
Succession Branch Office	69

Hospitality features	71
Set Automatic Wake-Up.....	71
Activate Message Registration	73
Use Maid Identification	74
Display Room Status	75

Flexible Feature Codes (FFCs)	77
--------------------------------------	-----------

Terms you should know	78
------------------------------	-----------

i2004 Internet Telephone

This document describes i2004 features and how to use the i2004 Internet Telephone. The i2004 Internet Telephone brings voice and data to the desktop by connecting directly to a LAN through an Ethernet connection.

Note 1: Not all features are available on all telephones. Consult your network administrator to verify which features are available for your use.

Note 2: In this guide, Programmable Line (DN)/Feature Keys (self-labeled) display beside the label. Soft Feature (self-labeled) keys display directly below the label.

i2004 Internet Telephone features

The i2004 Internet Telephone supports the following features:

- Twelve programmable feature keys: six (physical) Programmable Line (DN)/ Feature Keys (self-labeled) and six lines/features accessed by pressing the shift key
- Four Soft Keys (self-labeled) providing access to ten features
- Large multi-field LCD display
- Shared LAN access with a PC through an 3-Port integrated switch.
- Wideband-compatible speakerphone
- Headset jack with On/Off key
- Volume control bar for adjusting ringer, speaker, handset, and headset
- Six specialized fixed keys:
 - Quit
 - Directory
 - Inbox (Message)
 - Shift
 - Services
 - Expand to PC
- Call processing fixed keys:
 - Hold
 - Goodbye
 - Handsfree
 - Mute
- Automatic IP address
- Hearing-aid compatibility

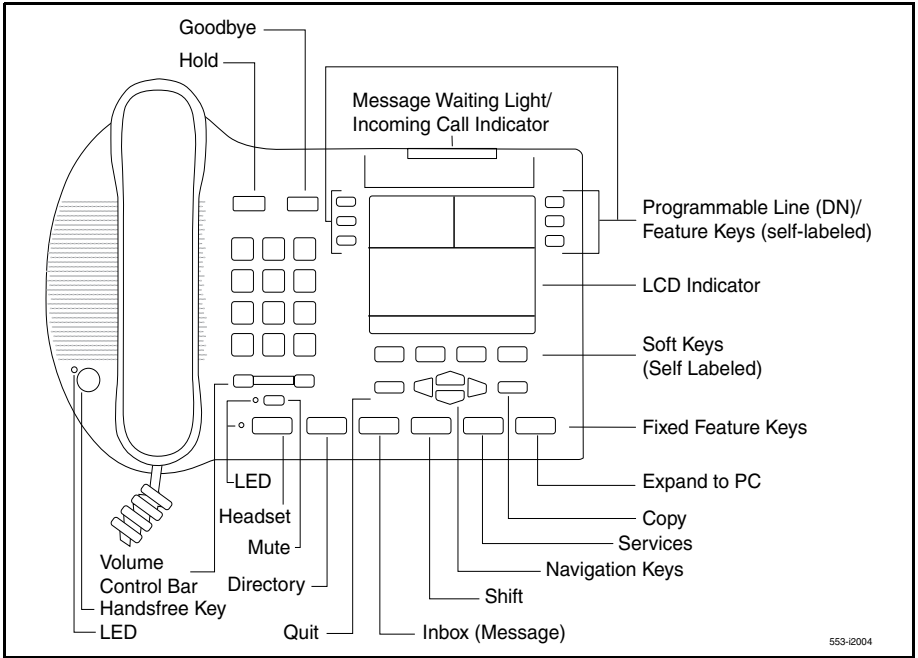

Telephone Controls



Use the **Volume Control** to adjust the volume of the Handset, Headset, Speaker, Ringer, and Handsfree features. Press the right side of the rocker bar to increase volume, the left side to decrease volume.



Use the **Goodbye** key to terminate an active call.



Press the **Headset** key to answer a call using the headset or to switch a call from the handset or Handsfree to the headset.

2498



A steady LCD light beside a **Line** (DN) key indicates the feature or line is active. A flashing LCD indicates the line is on hold or the feature is being programmed.



Press the **Hold** key to put an active call on hold. Press the **Line** (DN) key beside the flashing to return to the caller on hold.



Press the **Speaker** key to activate handsfree. The speaker LED lights to indicate when handsfree is active.



The **Expand to PC** key is a fixed key that is reserved for future development.



Press the **Inbox (Message)** key to access your voice mailbox.

Note: On the 3900 telephone series, the **Messages** key corresponds to the **Inbox (Message)** key.



Press the **Shift** key to toggle between two feature key pages and access an additional six lines/features.



Press the **Directory** key to access Directory services.



Press the **Mute** key to listen to the receiving party without transmitting. Press the **Mute** key again to return to a two way conversation. The **Mute** key applies to Handsfree, Handset, and Headset microphones. The Mute LED flashes when the **Mute** option is in use.



Use the **Navigation** keys to scroll through menus and lists in the display area.



Press the **Quit** key to end an active application. Pressing the **Quit** key does not affect the status of the calls currently on your telephone.



Press the **Services** key to access the following items:

- Telephone Option:
 - Volume Adjustment
 - Contrast Adjustment
 - Language
 - Date/Time Format
 - Display diagnostics
 - Local Dialpad Tone
 - Ring type
 - Call timer
 - OnHook Default Path
 - Change Feature key Label
 - Set Information
- Virtual Office Login and Virtual Office Logout (if *Virtual Office* is configured)
- Test Local Mode and Resume Local Mode (if *Branch Office* is configured)

2498  

The **Primary Directory Number** (DN) key are the Line/Feature keys located at the sides of the upper display area. When you pick up the handset, the line associated with this key can support a call.

Note: Although you can have additional DN keys assigned to your telephone, there is only one Primary DN.

More..



Press the **More..** key to access the next layer of **Soft Keys (self-labeled)** keys.

CallWait 

Programmable Line (DN)/Feature Keys (self-labeled) are configured for various features on the telephones.

FWD



Soft Keys (self-labeled) are located below the display area. The LCD label above the key changes, based on the active feature.

 FWD



Note: A triangle before a key label indicates that the key is active.

i2004 Internet Telephone display

This section summarizes the display features of the i2004 Internet Telephone. The Idle display is shown in the figure below.

The i2004 telephone has three display areas:

- The upper display area is used for line and feature key status.
- The middle display area contains a single line information display for items such as party and set information.
- The lower display area provides feature key labels.

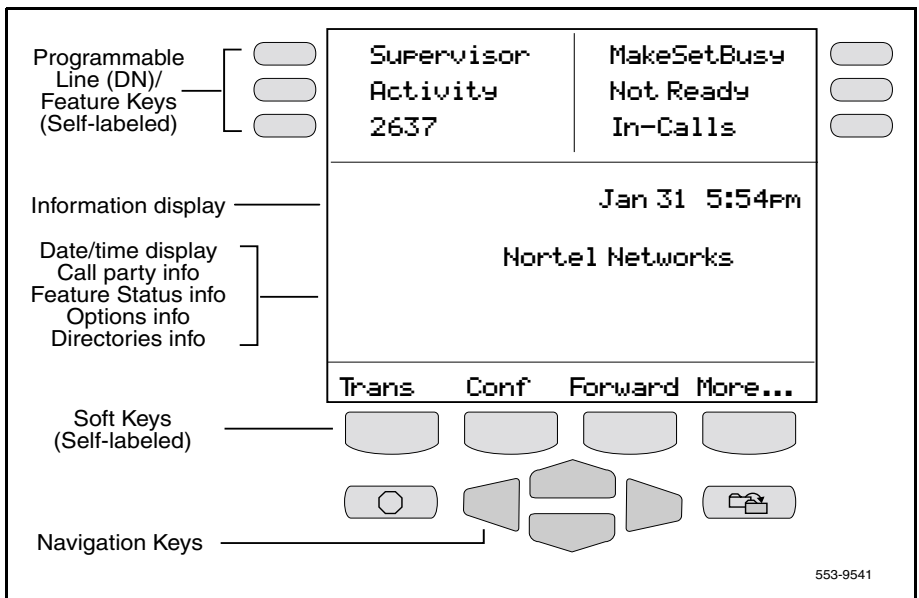

Install your i2004 Internet Telephone

Connect the i2004 telephone components



CAUTION

Damage to Equipment

Do not plug the i2004 Internet telephone into an ISDN connection. This results in severe damage to the i2004 telephone. Consult your system administrator to ensure that you plug your set into a 10/100BaseT Ethernet jack.

The i2004 can connect directly to a network or share access to a LAN with a PC. Two ports, the Network Ethernet and the PC Ethernet, are located on the back of the telephone and enable connections to a LAN and a PC. Two CAT-5 cable lines are required when sharing a LAN with a PC.

1. Connect one end of the handset cord to the handset jack (identified with a handset icon) on the back of the telephone and the other end to the jack on the handset.
2. Choose one of the following connections:
 - a. *For a telephone not sharing a LAN access with a PC,* connect one end of the CAT-5 line cable to the LAN ethernet port located on the back of the telephone (identified with a LAN icon). The other end of the CAT-5 line cable plugs into the IP network..
 - b. *For a telephone sharing a LAN access with a PC,* connect one end of the CAT-5 line cable to the LAN ethernet port located on the back of the telephone (identified with a LAN icon) and the other end to the IP network. Insert a second CAT-5 line cable into the PC ethernet port located on the back of the telephone (identified with a PC icon) and the other end into the computer's Ethernet port.
3. Contact your installation technician for the proper power option. This telephone can be powered by an AC adapter or over a LAN.
4. Thread the cord around the strain relief, retaining hook, and channel provided for a secure power connection.

- Secure the telephone footstand to the telephone base. Use the angle grip on the top back of the telephone to change position.

Rear view of i2004 Internet Telephone

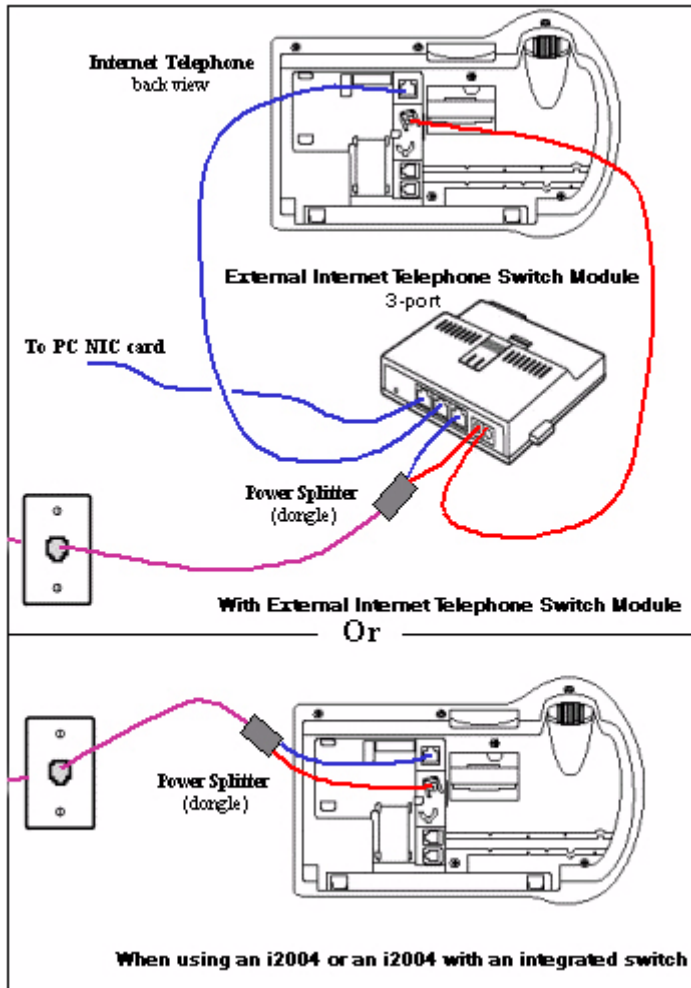

Your i2004 Telephone Option Menu

The i2004 Internet Telephone **Services** menu lists the following menus:

- The *Telephone Option* menu enables you or your Network Administrator to configure telephone preferences.
- The *Virtual Office Login* and *Test Local Mode* (for *Branch Office*) menus are listed when an i2004 Internet Telephone class of service is set for Virtual Office and Branch Office.

The *Telephone Option* menu offers the following options:

Volume adjustment...	Display diagnostics
Contrast adjustment	Local Dialpad Tone
Language...	Ring type...
Date/Time format...	Change Feature key label
OnHook Default Path	Set Information
Call Timer	

Note: The ellipses (...) appearing after the an option item indicate there is a sublist.

To use the Telephone Option Menu:



1. Press the **Services** key.



2. Using the **Navigation** keys to move up and down through the Services Menu, highlight **Telephone Option**.

Telephone Option

Select



3. Press the **Select** key.



4. Use the **Navigation** keys to scroll through the list of options that can be customized.

Language...

5. Highlight a feature to adjust (for example, **Language**).

Select



Select



or

Quit



6. Press the **Select** key. The display provides information required to adjust your selection.
7. Choose one of the following:
 - a. Press the **Select** key to save changes and return to the **Telephone Option** menu.
 - b. Press the **Quit** key to keep existing settings.

Adjust volume

After selecting **Volume adjustment..** from the **Telephone Option** menu, choose Ringer, Handset, or Handsfree for volume adjustment.

To adjust Ringer volume:

Ringer

Lower



or

Higher



1. Select **Ringer** from the **Volume** menu.
2. Press **Lower** to decrease volume, **Higher** to increase volume.
3. Choose one of the following:
 - a. Press the **Select** key to save the volume level and return to the **Telephone Option** menu.
 - b. Press the **Quit** key to keep existing settings.

To adjust Handset listen volume:

Handset listen

Lower



or

Higher



1. Select **Handset listen** from the **Volume** menu.
2. Press **Lower** to decrease volume, **Higher** to increase volume.
3. Choose one of the following:
 - a. Press the **Select** key to save the volume level and return to the **Telephone Option** menu.
 - b. Press the **Quit** key to keep the existing settings.

To adjust the Handsfree listen volume:

Handsfree listen

Lower



or

Higher



1. Select **Handsfree listen** from the **Volume** menu.
2. Press **Lower** to decrease volume, **Higher** to increase volume.
3. Choose one of the following:
 - a. Press the **Select** key to save the volume level and return to the **Telephone Option** menu.
 - b. Press the **Quit** key to keep existing settings.

To adjust the Headset listen volume:

Headset listen

Lower



or

Higher



1. Select **Headset listen** from the **Volume** menu.
2. Press **Lower** to decrease volume, **Higher** to increase volume.
3. Choose one of the following:
 - a. Press the **Select** key to save the volume level and return to the **Telephone Option** menu.

- b. Press the **Quit** key to keep existing settings.

To adjust the Buzzer volume:

Buzzer

Lower



or

Higher



1. Select **Buzzer** from the **Volume** menu.
2. Press **Lower** to decrease volume, **Higher** to increase volume.
3. Choose one of the following:
 - a. Press the **Select** key to save the volume level and return to the **Telephone Option** menu.
 - b. Press the **Quit** key to keep existing settings.

Adjust Screen contrast

The **Screen contrast** option enables adjustments to the telephone's display contrast. After selecting **Contrast Adjustment** from the **Telephone Option** menu:

Lower



or

Higher



1. From the **Contrast** screen, press **Lower** to decrease display contrast level, **Higher** to increase display contrast level.
2. Choose one of the following:
 - a. Press the **Select** key to save the contrast level and return to the **Telephone Option** menu.
 - b. Press the **Quit** key to keep existing settings.

Select a language

The display is available in multiple languages. After selecting **Language...** from the **Telephone Option** menu:



Deutsche

Select



1. Using the **Navigation** keys, highlight the desired language (for example, German [Deutsche]).
2. Choose one of the following:
 - a. Press the **Select** key to save the language and return to the **Telephone Option** menu.
 - b. Press the **Quit** key to keep existing settings.

Select Date/Time format

There are several Date/Time formats. Formats are based on the 12-hour and the 24-hour clock. After selecting **Date/Time format...** from the **Telephone Option** menu:



Select



1. Using the **Navigation** keys, highlight the desired format. Sample formats appear on the upper right side of the display area.
2. Choose one of the following:
 - a. Press the **Select** key to save the format and return to the **Telephone Option** menu.
 - b. Press the **Quit** key to keep existing settings.

Display diagnostics

The Display diagnostics option tests the telephone's display screen and indicator lights. After selecting **Display Diagnostics** from the **Telephone Option** menu:



1. Using the **Navigation** keys, scroll through the list to view display capabilities.
2. Press the **Quit** key to return to the **Telephone Option** menu.

Local Dialpad Tone

The Local Dialpad Tone option enables a pressed telephone dial key to produce Dual Tone Multi-Frequency (DTMF) sounds, a single tone, or no sound. After selecting **Local Dialpad Tone** from the **Telephone Option** menu:



1. Using the **Navigation** keys, highlight one of the following dial pad ring tones:
 - a. **None** to disable all tones.
 - b. **Short Click** to enable a single tone for all keys.
 - c. **DTMF** to turn on a separate DTMF tone for each key.
2. Choose one of the following:
 - a. Press the **Select** key to save the tone selection and return to the **Telephone Option** menu.
 - b. Press the **Quit** key to keep existing settings.

Select



Choose Ring type

The Ring type option sets the telephone's ring tone. After selecting **Ring Type...** from the **Telephone Option** menu:



Ring type 3

Play



Select



1. Using the **Navigation** keys, highlight one of the ring types.
2. Press the **Play** key to sample the ring tone.
3. Choose one of the following:
 - a. Press the **Select** key to save the ring type and return to the **Telephone Option** menu.
 - b. Press the **Quit** key to keep existing settings.

Enable Call timer

The Call timer measures how long you are on each call. After you select **Call timer** enable from the **Telephone Option** menu:

On



or

Off



1. From the **Call timer** screen, choose one of the following:
 - a. To turn on the Call timer, press the **On** key.
 - b. To turn off the Call timer, press the **Off** key.
2. Choose one of the following:
 - a. Press the **Select** key to save the changes and return to the **Telephone Option** menu.
 - b. Press the **Quit** key to keep existing settings.

Enable OnHook Default Path

When the set is on-hook, the OnHook Default Path option enables a Headset or a Handsfree connection. After selecting the **OnHook Default Path** from the **Telephone Option** menu:

handsfree enable



or

headset enable



Select



1. From the **OnHook Default Path** screen, choose one of the following:
 - a. Press the **handsfree enable** option.
 - b. Press the **headset enable** option.
2. Choose one of the following:
 - a. Press the **Select** key to save the default path and return to the **Telephone Option** menu.
 - b. Press the **Quit** key to keep existing settings.

Change Feature Key Label

The Change Feature Key Label option renames the label displayed next to each feature key or restores the default labels to the keys. After selecting **Change Feature Key Label** from the **Telephone Option** menu, choose one of the following:

To Change the labels:

Select a Feature key

Quit

Edit the Feature key label
<The new label displays here>

Select	Delete	Clear	More..
Select	Case	Clear	More..
Select	Symbol/Text	Clear	More..

1. From the **Change Feature Key Label** screen, press **Select** key.
2. Press the Feature key that is being changed.
3. Enter the new information for the feature key label. To enter special characters, press the up navigation key.

Note: If you enter a prime DN key, an error message displays.
4. Press the **Select** key to save the changes and return to the **Telephone Option** menu.

To restore the default labels:

Restore all key labels



Restore one key label



Choose one of the following:

1. To restore *all* default labels:
 - a. From the **Change Feature Key Label** screen, press **Restore all key labels** key.
 - b. Press **Yes** to change all feature keys to default values.

Note: When Yes is selected and values are changed to the default values, you can not undo the change. Feature key labels are erased in the memory. The label settings must be re-entered.

2. To restore *one* selected label:
 - a. Press **Restore one key label**.
 - b. Press **Select**.
 - c. Press a feature label key.
 - d. Select **Yes** to change the selected feature label key to the default value.

Set Information

The Set Information option displays the following set-specific information:

- IP address
- Hardware ID of the Internet Telephone
- Current firmware version
- TN programmed on set
- Node ID and IP address
- The Voice Gateway Media Card on which the Internet Telephone is registered.

After selecting **Set Information** from the **Telephone Option** menu:



1. Using the **Navigation** keys, scroll through the list to view Set information.
2. Press the **Quit** key to return to the **Telephone Option** menu.

Call features

System administration is required for Call features. Contact your system administrator to configure these features and codes on your telephone.

The Call features and Flexible Feature Codes (FFC) described in the following sections must be assigned to your telephone and supported by system software.

To access a feature, press a **Feature** key or enter a **Flexible Feature Code**.

Note: Whenever “Lift the handset” appears in this guide, you can also press the **Headset** or **Handsfree** button.

Make a call

This section describes features associated with making a call. There are several ways to make a call from an i2004 telephone.

To make a call:

2498



1. Do one of the following:
 - a. Press the **Line** (DN) key.
 - b. Lift the **Handset**.
 - c. Press the **Handsfree** key.
 - d. If a **Headset** is connected, press the **Headset** key.
2. Dial the number.

Make a call while on-hook

2498



1. Leave the **Handset** in the cradle.
2. Press a **Line** (DN) key.
3. Dial the number when dial tone sounds.
4. When the called party answers, lift the **Handset**.

Make a call while off-hook



1. Lift the **Handset**.
2. Dial the number.

Use Handsfree calling

Handsfree calling enables you to use the built-in microphone and speaker instead of the handset. While on an active call, you can switch between **Handset** and **Handsfree** mode.

To answer a call in Handsfree mode:



Press the **Handsfree** key.

To discontinue a Handsfree call:



Press the **Goodbye** key.

To mute a Handsfree call:



1. Press the **Mute** key. The LED indicator flashes.



2. Press the **Mute** key again to return to a two-way handsfree conversation.

To switch from Handsfree to Handset mode:

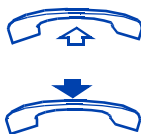

1. Lift the **Handset**.

2. Replace the **Handset** to end the call.

To switch from Handset mode to Handsfree mode:

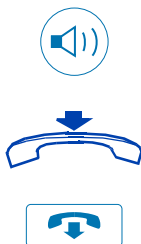

1. Press the **Handsfree** key.

2. Replace the **Handset**.

3. Press the **Goodbye** key to end the call.

To use a Headset:

1. Depending on the headset type and telephone, connect the **Headset** to the headset jack or the handset jack .
2. Press the **Headset** key.
Note: Amplified and unamplified headsets are compatible with the i2004 Internet Telephone.
3. Adjust your **Headset** volume by using **Volume adjustment...** in the **Telephone Option** menu.

To switch from Handsfree to Headset:

1. Connect the **Headset** and put the headset on.
2. Press the **Headset** key.

Use the Corporate Directory

Use the Directory feature to view, select, and dial Corporate Directory numbers.



Corporate Directory



Select



1. Press the **Directory** key to access Directory.
2. Using the **Navigation** key, highlight a Directory from the list.
3. Press the **Select** key.

To search for a specific number:



CASE



Search



Dial



1. When prompted, use the keypad to enter the desired name in the format, “Last, First”. To edit the entry, select from the following:
 - a. To toggle letters, use the 1-9 number keys.
 - b. For upper case letters, use the second level of feature keys and press the **Case** key.
 - c. For special characters, use the up and down **Navigation** keys (a **Choose** key appears for selecting the characters).
 - d. To remove the letter to the left of the cursor, press the **Delete** key.
2. Press the **Search** key to find the desired name.

Note: A successful search displays the first match on the screen.

3. Choose one of the following:
 - a. Press the **Dial** key to dial the resulting number.
 - b. If there is no match to the search query, start a new search or change the information in the initial search.
 - c. Press the **Quit** key to exit without dialing.

To scroll to a specific number:



1. Using the **Navigation** keys, scroll through the names in the Corporate Directory.

Note: To enable *Card View* (name, telephone number, and department name), use the Right key; use the Left key to return to *List View* after enabling.

Dial



2. Press the **Dial** key to dial the resulting number.

Note: If no DN number is associated with the directory entry, the message “No number in directory” displays. If there is no available DN key, a “No available line” message is displayed.

After the message displays, select **Done** to return to *List View* or *Card View*.

Use Predial

The Predial feature enables you to enter, preview, and edit numbers before dialing.

To use Predial:



2498



1. Without selecting a **Line** key, dial the number.
2. Press a **Line** key to dial the number.
3. Lift the **Handset** when the called party answers or, if in **Handsfree** mode, begin to talk.

To edit a Predial number:



2498



1. Without selecting a **Line** key, dial the number.
2. Use the **Navigation** keys to highlight the numbers and re-enter new numbers.
3. Press a **Line** key to dial the number.

Use Auto Dial

The Auto Dial feature displays, stores, and automatically dials telephone numbers.

To use Auto Dial:



AutoDial



1. Lift the **Handset**.
2. Selecting an associated **Auto Dial** key from the upper display area, press to dial the number.

To display Auto Dial number:

Display



AutoDial



1. Press the **Display** key.
2. Selecting from the upper display area, press the configured **Auto Dial** key.

To store an Auto Dial number:

AutoDial



AutoDial



1. Without lifting the handset, press the appropriate **Auto Dial** key.
Note: The display screen displays the word "Autodial" next to the appropriate key.
2. Dial the telephone number (including access code) to be stored on the selected **Auto Dial** key.
3. Press the **Auto Dial** key a second time to store the number on the selected key.
Note: Once a number has been stored, the word "Autodial" disappears, and the stored number displays.
4. Assign a label to the key (After assigning the label, the number disappears and only the label appears on the screen next to the key).

Activate Ring Again

Use the Ring Again feature if a busy tone sounds or when there is no answer after placing a call. Ring Again activates an audible tone notification that you receive when the person you tried calling is available or has used their telephone. **Ring Again** also automatically redials the number.

To use Ring Again:



RingAgn



1. Dial a number and receive a busy tone or no answer.
2. Choose one of the following:
 - a. Press the **Ring Again** key.
 - b. Enter the **Ring Again Activate FFC**.

To call a Ring Again party when you receive notification:



RingAgn



1. After receiving the notification tone, lift the **Handset**.
2. Press the **Ring Again** key to automatically dial the number.

To Quit Ring Again before notification:

RingAgn



Choose one of the following:

- a. Before hearing the notification tone, press the **Ring Again** key a second time.
- b. Enter the **Ring Again Deactivate FFC**.

Redial last number called

The Last Number Redial feature automatically redials the last dialed number.

To use Last Number Redial:



2498  

or

2498 

2498  

Choose one of the following

1. To redial using the **Handset**:
 - a. Lift the **Handset**.
 - b. Press the **Line** (DN) key.

2. Without lifting the **Handset**, press the **Line** (DN) key twice (the last number dialed is automatically redialed).

Use Speed Call

By entering a one, two, or three digit code (0–999), use the Speed Call feature to store, edit, and automatically dial frequently-called telephone numbers.

To store a Speed Call number:

SpcCtrl



SpcCtrl



1. Press the **Speed Call Controller** key. The triangular icon flashes, indicating programming mode.
2. At the prompt:
 - a. Enter a one-, two-, or three-digit code (0-999), and telephone number. (internal, external, or long-distance number).
 - b. If required, dial the access code.
3. Press the **Speed Call Controller** key again to save the code and number. The flashing icon turns off.

To make a Speed Call:

SpcCtrl



1. Lift the **Handset**.
2. Press the **Speed Call Controller** key.
3. Dial the **Speed Call** code to automatically dial the number.

Make a System Speed Call

Use the System Speed Call feature to dial Speed Call codes that override all restrictions on a call.

To make a System Speed Call:

SSucUsr



or

SScCtl



1. Lift the **Handset**.
2. Press the **System Speed Call** key or the **System Speed Call Controller** (SScCtl) key.
3. Dial the **Speed Call** code to automatically dial the number.

Use Hot Line

Use the Hot Line feature to automatically dial a specific number. Other features, such as Call Redirection, can be added to Hot Line. Call Redirection redirects a Hot Line call to be answered only by a person.

To use Hot Line:

HotLine



Press the **Hot Line** to automatically dial the number.

Make an Intercom call

Use the Intercom feature to call a member of your intercom group by pressing the code assigned to each member.

To make an Intercom call:

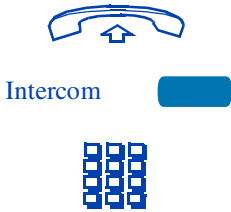

1. Lift the **Handset**.
2. Press the **Intercom** key.
3. Dial the one-digit or two-digit code for the desired intercom group member.

To answer an Intercom call while on a line other than your Intercom group line:

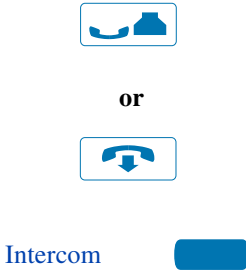

1. Press one of the following keys:
 - a. The **Hold** key to put the current call on hold.
 - b. The **Goodbye** key to end the call.
2. Press the **Intercom** key and begin to speak.

Answer a call

Each incoming call causes the telephone to ring and the LCD indicator  to flash.

To answer a call:



or



or

2498



or



1. Choose one of the following:

- a. Lift the **Handset**.
- b. Press the **Handfree** button located on the left side of the handset.

Note: The **Handsfree** feature may not be available on your telephone.

- c. Press the **Line** (DN) key beside the LCD indicator as it flashes.
- d. Press the **Headset** key if a headset is connected to your telephone.

While on an active call

This section describes features available during an active call.

Place a call on hold

Use the Hold feature when talking on one line and another call arrives on a second line. Retain the original call by putting it on hold and then answer the second call.

To place a call on hold:



Press the **Hold** key. The LCD indicator flashes beside the line on hold.

Note: If **Automatic Hold** is enabled, the active call is automatically put on hold when you answer the second call.

To retrieve a call on hold:



Press the **Line** (DN) key beside the flashing LCD indicator.

Transfer a call

Use the Transfer feature to redirect a call to the appropriate person.

To use the Transfer feature to direct a call to a third party:

TRANSFER



TRANSFER



1. Press the **Transfer** key. The other party is on hold and a dial tone sounds. The LCD indicator light flashes steadily.
2. Dial the DN number to which the call is transferred.
3. When that number rings or a person answers, press the **Transfer** key.

To go back to the original call, if the transfer is incomplete:



If the person called is not available, press the **Line** (DN) key (next to the LCD indicator) to reconnect to the original call.

Use Timed Reminder Recall

Use the Timed Reminder Recall feature to receive a reminder tone when a transferred call is not answered.

To use Timed Reminder Recall:

TRANSFER



TRANSFER



or



1. Press the **Transfer** key. The call is put on hold.
2. Dial the number to which the call is being transferred.
3. Choose one of the following:
 - a. Press the **Transfer** key again.
 - b. Replace the **Handset** before the extension answers. This starts the recall timer.

Note: If the transfer is complete, the recall timer stops.

If the transferred call is not answered, your telephone rings:



1. Lift the **Handset** to reconnect to the original caller.
2. Choose one of the following:
 - a. Press the **Transfer** key and repeat the transfer (to a different DN).
 - b. If the transfer is picked up while you are on the line, press the **Goodbye** key to complete the transfer.

TRANSFER



Use Attendant Recall

Use the Attendant Recall feature to contact an attendant during a call and to connect the call to the attendant.

To contact the attendant while on a call:

AttRecal



1. Press the **Attendant Recall** key and stay on the line until the attendant answers.
2. Press the **Goodbye** key. The caller remains connected to the attendant.

Use Call Park

Use the Call Park feature to hold temporarily (parked) and retrieve a call from any telephone. Using Call Park does not tie up a line and, when configured network-wide, can be used across networks. A **System Park Extension** can be set to automatically park most calls.

To park a call on the System Park DN or your own DN:

Park

Park



During an active call, press the **Park** key twice.

By default, the call is parked on your DN unless a **System Park** is enabled to automatically park calls on the system.

To park a call on a DN other than the System Park DN or your own DN:

Park



Park



1. Press the **Park** key.
2. Dial the DN where you want to park the call.
3. Press the **Park** key.

To park a call using the SPRE code or FFC:

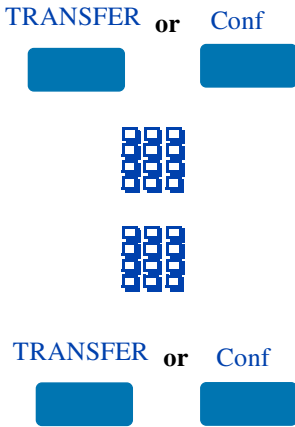

1. Press the **Transfer** key or the **Conference** key.
2. Dial the **Call Park FFC**.
3. To use an alternate DN from the **System Park** DN or your own DN, dial the DN where you want to park the call.
4. Press the **Transfer** key or the **Conference** key.

To retrieve a parked call:

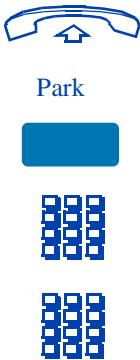

1. Lift the **Handset**.
2. Press the **Park** key.
3. Dial the **Call Park FFC**.
4. Dial the **DN** where you parked the call.
Note: If a parked call is not retrieved within a specified period of time, it rings back to your telephone or to the attendant.

Record a Calling Party Number

Use the Calling Party Number feature to record a caller's number or charge a call to an account number for accounting purposes during an established call.

To record a caller's number for accounting purposes:

CParty



CParty



1. Press the **Call Party** key to place the caller on hold. The Entered number displays.
2. Dial a charge account number or the caller's number.

Note: For information on using the **Charge** key, see “Charge a call or Charge a Forced call” on page 57.

3. Press the **Call Party** key to return to the call.

Display incoming calls

Use the Display feature to display a second incoming caller's number and name (if available) during an active call, without interfering with the call in progress.

To view the information on an incoming call while on a call in progress:

Display



2498



1. Press the **Display** key.
2. Press the flashing **Line** (DN) key. The call waiting information displays.

Note: When used with other feature keys, the **Display** key displays information associated with those feature keys.

Trace a Malicious call

Use the Malicious Call Trace feature to trace nuisance calls within your system.

To use Call Trace while on a call:

CallTrace



Press the **Call Trace** key.

To use Call Trace without a Call Trace key:

TRANSFER

or

Conf



1. Press the **Transfer** key or the **Conference** key.
2. Dial the **SPRE code** followed by **83** or dial the **Call Trace FFC** to automatically reconnect.

Incoming calls

This section describes features that are used with incoming calls.

Activate Automatic Answerback

When the Automatic Answerback feature is active, your set automatically answers in handsfree mode after one ring; however, calls are *not* forwarded to the voice message service.

To activate Automatic Answerback:

AutoAns



Press the **Automatic Answerback** key.

To deactivate Automatic Answerback:

AutoAns



Press the **Automatic Answerback** key again.

Activate Call Pickup

Use the Call Pickup feature to pick up calls from any telephone in the same pickup group or another pickup group.

To answer a call in your own Call Pickup group:



Pickup



1. Lift the **Handset**.
2. Press the **Pickup** key, or enter the **Pickup Ringing Number FFC**.

To answer an incoming call in another Call Pickup group:



GrpPkp



1. Lift the **Handset**.
2. Press the **Group Pickup** key or enter the **Pickup Group FFC**.



To answer a call at a specific extension in any pickup group:



DN Pickup



3. Dial the pickup group number of the ringing telephone.

1. Lift the **Handset**.
2. Press the DN **Pickup** key, or enter the **Pickup Directory Number FFC**.
3. Dial the DN of the telephone that is ringing (in your call pickup group).

If the pickup DN or group number is invalid (an overflow burst tone sounds and the screen displays *Goodbye and try again*), press the **Goodbye** key.

Use Call Waiting

Use the Call Waiting feature to alert you to an incoming call by producing a tone. It also puts the current call on hold, while you answer the new call.

To answer an incoming call while on another call:



CallWait



1. When the incoming call tone sounds, press the **Hold** key to put a current call on hold.

Note: If **Automatic Hold** is enabled, it is not necessary to press the **Hold** key.

2. Press the **Call Waiting** key.

To return to the first telephone call:



or



1. Choose one of the following:
 - a. Press the **Hold** key to put the second call on hold.
 - b. Press the **Goodbye** key to end the second call.

Incoming calls

2498



2. Press the **Line** (DN) key associated with the first call.

If you do not have a Call Waiting key:



1. Press the **Goodbye** key to end the current call and answer the incoming call.

2498



2. Press the **Line** (DN) key beside the flashing status icon to answer the incoming call.

While you are away from your desk

This section describes features that are used when you are away from your desk.

Use Call Forward

Use the Call Forward feature to direct incoming calls to ring at another **Line** (DN). If the telephone is in the process of ringing, that call cannot be forwarded.

To forward your calls or change the forward number:

Forward



Forward



1. Press the **Forward** key or lift the **Handset** and enter the **Call Forward All Calls Activate FFC**.
2. Dial the DN where you want to forward your calls.
3. Press the **Forward** key.

To Quit Call Forward:

Forward



Press the **Forward** key or lift the **Handset** and enter the **Call Forward All Calls Deactivate FFC**.

To reinstate Call Forward to the same number:

Forward



Forward



Press the **Forward** key twice.

Use Internal Call Forward

Use the Internal Call Forward to accept only calls originating at internal DNs to ring at another DN. Calls originating outside your telephone system still ring at your telephone. Current incoming calls cannot be forwarded.

To forward internal calls:

IntForward



IntForward



1. Press the **Internal Call Forward** key or lift the **Handset** and enter the **Internal Call Forward Activate FFC**.
2. Dial the DN to which your internal calls will be forwarded.
3. Press the **Internal Call Forward** key.

To Quit Internal Call Forward:

IntForward



Press the **Internal Call Forward** key or lift the **Handset** and enter the **Internal Call Forward Deactivate FFC**.

To reinstate Call Forward to the same number:

IntForward



IntForward



Press the **Internal Call Forward** key twice.

Use Remote Call Forward

Use the Remote Call Forward feature to forward calls (from any telephone other than your own) to any telephone.

To activate Remote Call Forward:



#

1. Lift the **Handset**.
2. If calling from a telephone outside the system, dial your direct system access number and wait for dial tone.
3. Dial the **Remote Call Forward Activate FFC** to activate the feature.
4. Dial your Station Control Password. A dial tone sounds.
5. Choose one of the following:
 - a. Dial your DN.
 - b. To forward calls to the previous call forward telephone number, press the **#** key. (Do not perform steps 6 and 7).
6. Dial the number to which calls are being forwarded. If calls are forwarded to an invalid number, a fast busy signal sounds.
7. Press the **#** key.

To Quit Remote Call Forward:



#

1. Lift the **Handset**.
2. If calling from a telephone outside the system, dial the direct system access number and wait for the dial tone.
3. Dial the **Remote Call Forward Deactivate FFC**.
4. Dial your **Station Control Password**.
5. After hearing the dial tone, dial your DN.
6. Press the **#** key.

Secure your telephone

Use the Electronic Lock feature to prevent others from making calls from your telephone. The lock consists of a password that you can change.

To lock your telephone:



1. Lift the **Handset**.
2. Dial the **Electronic Lock Activate FFC**.
3. Dial your **Station Control Password**.
4. Choose one of the following:
 - a. If dialing locally, press the **Good-bye** key.
 - b. If dialing remotely, dial your DN.

To unlock your telephone:



1. Lift the **Handset**.
2. Dial the **Electronic Lock Deactivate FFC**.
3. Dial your **Station Control Password**.
4. Choose one of the following:
 - a. If dialing locally, press the **Goodbye** key.
 - b. If dialing FFC remotely, dial your DN.

To change your password (must be done from your telephone):



1. Lift the **Handset**.
2. Dial the **Station Control Password Change FFC**.
3. Dial the current password for your telephone.
4. Dial the new password.
5. Dial the new password again.
6. Press the **Goodbye** key.

Talk with more than one person

This section describes features that enable conversations between more than two people.

Use the Call Join feature

Use the Call Join feature to connect calls to the current active call. This creates a conference between the two callers and yourself.

To connect a call on hold (on a different line) to your current call:

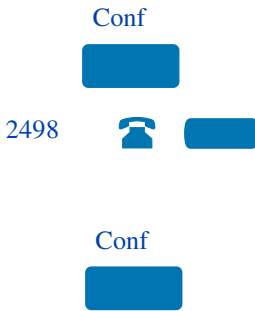

1. Press the **Conference** key.
2. Press the **Line** key that has the number of the caller you want to connect to your current call.
3. Press the **Conference** key again to join the person on hold to your conversation.

Set up a Conference call

Use a Conference call for three (or six, depending on your telephone's configuration) people, including yourself.

To set up a conference call:



1. While on a call, press the **Conference** key to place the party on hold. You receive dial tone.
2. Dial the number of the person you want to add to the conference call. You can talk privately to the person you are adding at this time.
3. Press the **Conference** key a second time to conference all parties together.
4. If necessary, repeat the procedure until four people are in the conference.

If the person you attempt to add to the conference is unavailable:



2498



1. Press the **Goodbye** key.
2. Press the **Line (DN)** key with the flashing icon to return to your original call.

Use the Conferee selectable display and disconnect feature

Use the Conferee Selectable Display feature to list active conferees and disconnect a conferee from the conference call.

To view active conferees:

ConfSelDsp



1. While on a conference call, press the **Conferee Selectable Display** key to turn on the LCD indicator. Each key press changes the screen to show a different active conferee.

Note: This action has no effect on the display of other telephones involved in the conference.



2. Press the **Goodbye** key. If configured, the **Conference Count Display** returns an updated total count of conferees. The LCD indicator turns off.

To disconnect a conferee:

ConfSelDsp



1. While on a conference call, press the **Conferee Selectable Display** key until the conferee you want to disconnect appears on the screen.
2. Press the **DN** key on which the conference call is established.
3. Choose one of the following:
 - a. For a single conferee, press the **Goodbye** key. If configured, the **Conference Count Display** returns an updated total count of conferees.

2498



The LCD indicator turns off.

- b. For multiple conferees, repeat steps 1 and 2 until all conferees are disconnected then press the **Goodbye** key.

Use Group Call

Use the Group Call feature to automatically call members of a predefined group, one at a time, until they all answer.

To call group members:



GroupCall



1. Lift the **Handset**.
2. Press the **Group Call** key or enter the **Group Call FFC**.

The feature automatically calls all group members. The icon flashes until all members answer.

The telephone numbers of the group members appear on the display as they answer. When the last person answers, the **Group Call** indicator lights steadily.

When a person in your group is on a conference call or another group call, they are not connected to your group call.

After everyone in the group has answered, only the person who made the group call can put the call on hold.

To answer a Group Call:

Lift the **Handset**.

Note: About Notification Tones:

- a. If you are on a call and receive three 10-second tones, this is the notification of a group call on your current extension.
- b. If you are on a call on another line on your telephone when a group call is made, you receive a long tone through the handset or speaker.
- c. You do not receive notification of a group call if you are already on a conference call or another group call.

To end a Group Call:

Press the **Goodbye** key.

Note: When the person who made the group call disconnects, the call terminates for all members of the group. However, the members of the Group Call can disconnect from the call and not affect other members on the call.

Work without interruption

This section describes features that provide uninterrupted work time.

Activate Make Set Busy

Use the Make Set Busy feature to make your telephone appear busy to all callers.

To activate Make Set Busy:

MakeSetBsy



Press the **Make Set Busy** key or lift the **Handset** and enter the **Make Set Busy Activate FFC**.

To deactivate Make Set Busy:

MakeSetBsy



Press the **Make Set Busy** key a second time to deactivate the feature or lift the **Handset** and enter the **Make Set Busy Deactivate FFC**.

Additional Call Features

Auto Dial Transfer Feature

Use the Auto Dial Transfer feature to transmit digits through your Auto Dial key to the central office after a Trunk Switchhook Flash. You must be on a Central Office/Exchange (CO) trunk call from or to a CO that offers Centrex or exchange line-type features.

To use Auto Dial Transfer when picking up an incoming trunk call:

CentrexSHF



AutoDial



1. Press the **Centrex Switchhook Flash** key and wait for interrupted dial tone.
2. Press the **Auto Dial** key to call the number desired.
3. Press the **Goodbye** key to end the call.

Use the Buzz signal

Use the Buzz feature to notify another person of a call, a visitor, or a request. Two telephones that are linked together enable one person to signal the other. The person signaled hears a buzz.

To buzz the telephone linked to your telephone:

Buzz



1. Press the **Buzz** key.

The telephone that links to your telephone, buzzes as long as you press the key.

Buzz



2. When you are finished signaling, press the **Buzz** key.

Use Call Page Connect to make an announcement

Use the Call Page Connect feature to make an announcement over a paging system.

Note: A **Page** key on an attendant console overrides and disconnects the telephones. The telephones must re-access the page trunk.

To connect to Call Page:

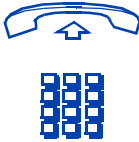

1. Lift the **Handset**.
2. Dial the **Page Trunk Access Code** to complete the connection to the page system.
3. Make your announcement.

To disconnect Call Page:



4. Press the **Goodbye** key.

Use Centrex/Exchange Switchhook Flash

Use the Centrex/Exchange Switchhook Flash feature during an established call to use a Centrex service, such as Call Transfer or Three-Way Calling.

To use Centrex/Exchange Line Switchhook Flash:

CentrexSHF 



1. While in a call, press the **Centrex Switchhook Flash** key.
A special dial tone sounds.
2. Dial the codes for your custom **Centrex** feature.
3. Press the **Goodbye** key to end the call.

Charge a call or Charge a Forced call

Use the Call Charge feature to charge a call to a specific account. The Forced Charge feature charges long-distance calls from a telephone restricted to local calls.

To charge a local or long-distance call to an account before you dial:



Charge



1. Lift the **Handset**.
2. Press the **Charge** key or dial the **Call Detail Recording FFC**.
3. Dial the charge account number.
4. When the dial tone sounds, dial the number.

To charge a call in progress:

TRANSFER

Conf

or



Charge



2498



1. Press the **Transfer** key or the **Conference** key.
2. Press the **Charge** key or dial the **Call Detail Recording FFC**.
3. Dial the charge account number.
4. Press the **Line** (DN) key to return to the call.

To charge a call to an account when you transfer a call:

TRANSFER



Charge



TRANSFER



1. Press the **Transfer** key. The call is on hold.

2. Press the **Charge** key **or** dial the **Call Detail Recording FFC**.

3. Dial the charge account number.

4. After the dial tone, dial the number to where the call is to be transferred.

5. Press the **Transfer** key when you hear the telephone ring.

Note: You can talk privately to the person at the transfer number before you press the Transfer key.

To charge a call to an account when you add someone to a conference call:

Conf



Charge



Conf



1. Press the **Conference** key. The call is placed on hold.

2. Press the **Account** key **or** dial the **Call Detail Recording FFC**.

3. Dial the charge account number.

4. Dial the number of the person you want to add to the conference.

5. Press the **Conference** key.

Use Enhanced Override Feature

Use the Enhanced Override feature to override an active call after you have attempted a Forced Camp-on. Use Enhanced Override to make a simple call or a consultation call (such as, placing a call on hold and calling another party).

To use Enhanced Override:



Override



You are receiving a busy signal after dialing a telephone number.

1. Press the **Override** key or enter the **Override FFC** to initiate a Forced Camp-on.

If either person on the call disconnects at this time, you receive an overflow (fast busy/engaged) signal.

Override



2. Press the **Override** key again or enter the **Override FFC** again.

The other two persons on the call receive an override tone and a conference call is established between the three of you. If anyone disconnects, the other two persons remain connected.

To end the connection:



Press the **Goodbye** key.

Use Forced Camp-on feature

Use the Forced Camp-on feature to automatically ring another telephone (internal or external) immediately after that telephone disconnects from its current call. Forced Camp-on in conjunction with Priority Override is referred to as Enhanced Override.

To use Forced Camp-on:



Override



You are receiving a busy signal after dialing a telephone number.

1. Press the **Override** key or enter the **Override FFC**, to initiate a Forced Camp-on.

Note: The person you called receives a tone, and you receive a ring/ringback signal or busy/engaged signal, depending on the options chosen. You are now camped-on to the number you dialed.

2. When the person you called finishes their call, your telephone automatically dials the number. Both your telephone and their telephone rings.

To answer a call camped-on to your extension:



When the telephone rings, lift the **Handset**.

Note: You can program your telephone for either Camp-on or Call Waiting, but not both.

Override a busy signal

Use the Override feature to override a busy signal and interrupt another call.

To override a busy/engaged signal:



Override



1. Dial a telephone number and receive a busy signal.
2. Press the **Override** key, or enter the **Override FFC**.

The people in the targeted call receive a tone for approximately one second. After **Override** joins you to their call a short tone repeats every sixteen seconds.

To end the connection:



Press the **Goodbye** key.

Use Privacy Release

Use the Privacy Release feature to enable one or more people who share your DN to join a call.

To use Privacy Goodbye in an established state:

PrivRls



Press the **Privacy Release** key during a call. A person joins the call by pressing the shared number (DN) key on their telephone (**Multiple Appearance DN** feature).

Use Radio Page

Use an on-site Radio Page system feature to page a person and stay on the line until they answer. The paged person answers the call after entering a special Page Meet-me code from any telephone.

To use Automatic Preselection (Meet -me page):



1. Lift the **Handset**.
2. Dial the **Radio Paging Access FFC**. The page dial tone sounds.
3. Dial the number of the party you want to page. After dialing, the ringback tone sounds.

Note: The paged person can use any telephone to enter a **Radio Paging Answer FFC**, plus their own DN number.

4. If your call goes unanswered for a preset time period, after which a 15-second high pitched tone sounds followed by a silence, press the **Goodbye** key or replace the **Handset**.

To use Automatic Post selection:

RadioPage



The called party is either busy on the telephone or away from the desk.

To page the called party, there is no need to redial the number of the called party.

1. Press the **Radio Page** key. A special dial tone sounds.
2. Dial the **Radio Paging Access FFC**. The ringback tone sounds.

Note: The paged person can use any telephone to enter a **Radio Paging Answer FFC**, plus their own DN number.

3. If your call goes unanswered for a preset time period, after which a 15-second high pitched tone sounds followed by silence, then press the **Goodbye** key or replace the **Handset**.

To answer a Radio Page:



If you carry a Radio Pager, a page indicates that someone dialed your **Directory Number** (DN).

If the **Radio Page** system is set up to function in **Meet-me** mode, you can answer the page call from any telephone.

1. Lift the **Handset**.
2. Dial the **Radio Page Answer FFC**. The paging tone sounds.
3. Dial your own DN to connect to the paging caller. If the caller hung up, a steady high pitched (Number Unavailable) tone sounds.

Use Voice Call

Use the Voice Call feature to page another person or make an announcement through someone else's telephone speaker.

To make a voice call:



VoiceCall



1. Lift the **Handset**.
2. Press the **Voice Call** key and make the announcement.
3. Press the **Goodbye** key.

To respond to a voice call:



Your telephone rings once and the caller's voice transmits through your speaker. Lift the **Handset**.

Additional Features

Virtual Office

When you are away from your office telephone, use the Virtual Office feature to transfer calls and features to another telephone.

When designated as the office telephone, the i2004 can be activated for Virtual Office by a i2050 or another i2004. When used as the remote telephone, the i2004 can activate an i2002 or i2004 for Virtual Office.

Virtual Office Login

Note: You *cannot* activate i2004 and i2050 telephones with an i2002 telephone.

To activate Virtual Office on your Office telephone from your Remote telephone:



Virtual Office Login

Select



Select



1. Press the **Services** key to access the Services menu.
2. Using the **Navigation** key, highlight **Virtual Office Login**.
3. Press the **Select** key. The display provides a prompt for the User ID.

4. Enter your DN with the access code.
Note: This must be an ESN number.

5. Press the **Select** key to move to the password prompt.

6. Enter the home **Station Control Password (SCPW)**.

7. If the User ID is not found locally, “Locating Remote Server” appears on the screen.

Note: After three failed login attempts, you must wait one hour before attempting to login again.

Virtual Office on your Remote Telephone

A successful login transfers all the features, time, date and tones to your remote telephone from your office telephone.

Logged on to i2004

Figure 1: Logged in using a i2004

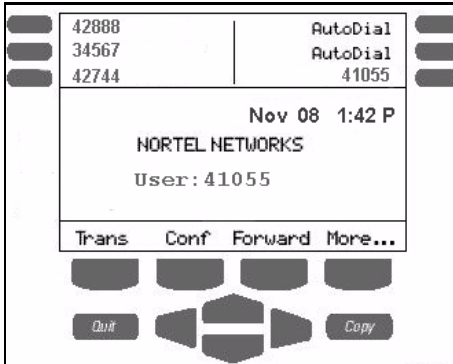
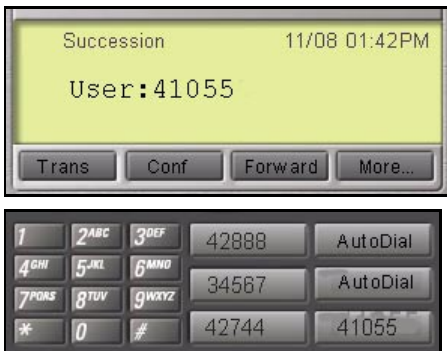
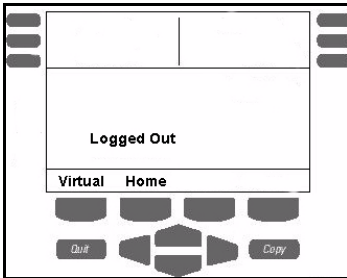

Figure 2: Logged in using a i2050



A User information line displays the number on your i2004 or i2050 telephone.

Virtual Office on your Office Telephone



When activated for Virtual Office by a remote telephone, your office telephone is *logged out* and is no longer operational.

A Logged Out screen is displayed on your telephone alerting you that it is being used for Virtual Office.

To regain operation of a telephone being used for Virtual Office:

Home



Virtual



To regain operation of your telephone being used for Virtual Office, choose one of the following:

1. To completely disconnect your office telephone from the remote telephone:
 - a. Press the **Home** key.
 - b. Enter your User ID and password (this logs the office telephone back on to your office network).
2. To use your office telephone as the remote telephone for Virtual Office, press the **Virtual** key to login to another telephone.

Virtual Office Logout

To log out from your remote telephone:



Virtual Office Logout



Select



1. Press the **Services** key to access the menu.
2. Using the **Navigation** keys, highlight **Virtual Office Logout**.
3. Press the **Select** key.

Troubleshoot Virtual Office

When using Virtual Office you may encounter error messages displayed on your screen. The following table lists error messages and actions to correct the causes.

Table 1: Troubleshoot Virtual Office

Displayed Message	Probable Cause	Actions
Busy, try again.	Remote telephone is active on a call.	Wait for remote telephone to become idle and try again.
	ACD set to Login is logged in.	Log out ACD set from a queue before Virtual Office login to it from another telephone.
	Make-Set-Busy is inactive on ACD set to log in.	Set Make-Set-Busy active on ACD set to log in.
Invalid ID (1)	Incorrect User ID entered.	Enter correct User ID.
	User ID not in Gatekeeper database.	Notify local network administrator.
Invalid ID (2)	Incorrect User ID entered.	Enter correct User ID.
Locked from Login	Failed to enter the correct Station Control Password three times.	Wait one hour for the lock to clear automatically, or notify local network administrator to clear lock.
Permission Denied (3)	Incorrect User ID entered.	Retry with correct User ID.
	Remote telephone has no Station Control Password.	Notify local network administrator.

Table 1: Troubleshoot Virtual Office

Displayed Message	Probable Cause	Actions
Permission Denied (4)	<p>Incorrect User ID entered.</p> <p>Attempt to Login to a remote i2004 or i2050 telephone from an i2002 telephone.</p>	<p>Retry with correct User ID.</p> <p>Go to an i2004 or i2050 telephone and try again.</p>
Permission Denied (5)	<p>Incorrect User ID entered.</p> <p>Remote telephone does not have VOUA Class of Service.</p>	<p>Retry with correct User ID.</p> <p>Notify local network administrator.</p>
Permission Denied (6)	<p>Incorrect User ID entered.</p> <p>Incorrect Station Control Password entered.</p>	<p>Retry with correct User ID.</p> <p>Select Retry, and try again with the correct Station Control Password.</p>
Server Unreachable (1)	Network problem.	Notify network administrator if problem persists.
Server Unreachable (2)	Network problem.	Notify network administrator if problem persists.

Succession Branch Office

The Branch Office telephone can operate in Normal Mode or Local mode.

Normal Mode

The telephone registers with the Main Office and receives telephone services from the Main Office. At any time during Normal Mode you can check local mode functionality (make and receive calls) by enabling Local Mode and returning to Normal Mode. After testing, you can return to Normal Mode by using the *Resume Normal Mode* command or by waiting for ten minutes.

Local Mode

If the WAN connection goes down the telephone loses communication with the Main Office TPS. It then registers with the Branch Office and receives telephone services from the Branch Office. When in Local Mode, the telephone displays "LOCAL MODE".

Test Local Mode

Use Test Local Mode to check local mode functionality (make and receive telephone calls). This is useful when provisioning has changed for an Internet Telephone on a Branch Office Controller. .



Test Local Mode



Select



1. Press the **Services** key to access the Services menu.
2. Using the **Navigation** keys, highlight **Test Local Mode**.
3. Press the **Select** key (The telephone resets and registers to the Branch Office).

Resume Normal Mode

Use the Resume Normal Mode command to return to Normal Mode after testing survival functionality.

Note: If the Resume Normal Mode command is not performed after testing , the telephone automatically returns to Normal Mode in ten minutes.



Resume Normal Mode



Select



1. Press the **Services** key to access the Services menu.
2. Using the **Navigation** key, highlight **Resume Normal Mode**.
3. Press the **Select** key (the telephone registers back to the Main Office).

Troubleshoot Branch Office

When using Branch Office you may see error messages on your screen. The following table lists error messages and corrective actions.

Table 2: Troubleshoot Branch Office

Display Message	Probable Cause	Actions
Local Mode	Test Local mode. Network problem.	Press Services key and select Resume Normal Mode. Contact Local network administrator if problem persists.
Local Mode Invalid ID (1)	Gatekeeper unable to find end point from Branch User ID.	Notify local network administrator.
Local Mode Invalid ID (2)	Branch User ID not found in any equipped TN.	Notify local network administrator.

Hospitality features

The hospitality features in this section are intended for hotel operations.

Set Automatic Wake-Up

Use the Automatic Wake-Up feature to receive a timed reminder call. From your telephone, you can program the Meridian 1 to automatically place a call to yourself at a predetermined time. When you answer the call, recorded music plays for up to 30 seconds, followed by a prerecorded announcement or the attendant.

To enter the time for an Automatic Wake-Up call:



1. Lift the **Handset**.
2. Dial the **Automatic Wake-Up Request FFC**.
3. Dial the **Automatic Wake-Up** time in a 24-hour time format (hhmm). A tone sounds to confirm your entered time.
Note: In a 24-hour time format, 7:30 a.m. is entered as 0730; 9:45 p.m. is 2145.
4. Press the **Goodbye** key.

To Quit an Automatic Wake-Up call:



1. Lift the **Handset**.
2. Dial the **Automatic Wake-Up Quit FFC**.
3. Press the **Goodbye** key.

To verify the time for the Automatic Wake-Up call:



1. Lift the **Handset**.
2. Dial the **Automatic Wake-Up Verify FFC**.
3. Dial the **Automatic Wake-Up** time in a 24-hour time format (hhmm). If your query matches the preset time, a confirmation tone sounds.
Note: In a 24-hour time format, 7:30 a.m. is entered as 0730; 9:45 p.m. is 2145.
4. Press the **Goodbye** key.

Activate Message Registration

Use the Message Registration feature to read, change, or reset meters that log your hotel telephone calls.

To read meters:

MsgReg



1. Press the **Message Registration** key.
2. Dial the room Directory Number (DN).

MsgReg



3. Press the **Message Registration** key again.

To change a meter:

MsgReg



1. Press the **Message Registration** key.
2. Dial the room DN number.



3. Dial the correct meter count.

*

4. Press the * key.

MsgReg



5. Press the **Message Registration** key again.

To reset a meter to zero:

MsgReg



1. Press the **Message Registration** key.



2. Dial the room Directory Number (DN).

*

3. Press the * key.

MsgReg



4. Press the **Message Registration** key again.

Use Maid Identification

Use the Maid Identification feature to track the cleaning status of rooms. The maid enters the information from the telephone in each room.

To enter cleaning status:

RoomStatus



1. Press the **Room Status** key.
2. Dial the Directory Number (DN) for the room for which the cleaning status is being changed.
3. Dial one of the following cleaning status codes:
 - 1 = Cleaning requested
 - 2 = Cleaning in progress
 - 3 = Room cleaned
 - 4 = Room passed inspection
 - 5 = Room failed inspection
 - 6 = Cleaning skipped
 - 7 = Not for sale

The interrupted dial tone sounds.

*



RoomStatus



4. Press the * key.
5. Dial the **Maid ID**. If you dial the wrong **Maid ID**, press the * key and redial the ID.
6. Press the **Room Status** key.

Display Room Status

The Room Status feature prints the status of a room using the Display Module.

To read the status of a room:

RoomStatus



1. Press the **Room Status** key.
2. Dial the Directory Number (DN) for the room. The DN displays followed by a two-digit code.
 - a. The first digit indicates the occupancy status:
 - 0 = Room vacant
 - 1 = Room occupied
 - b. The second digit indicates the cleaning status of the room:
 - 1 = Cleaning requested
 - 2 = Cleaning in progress
 - 3 = Room cleaned
 - 4 = Room passed inspection
 - 5 = Room failed inspection
 - 6 = Cleaning skipped
 - 7 = Not for sale

RoomStatus



3. Press the **Room Status** key.

To change the status of a room:

RoomStatus



1. Press the **Room Status** key.
2. Dial the Directory Number (DN) for the room. The DN displays followed by a two-digit code.
 - a. The first digit indicates the occupancy status:
 - 0 = Room vacant
 - 1 = Room occupied
 - b. The next digit indicates the cleaning status of the room:
 - 1 = Cleaning requested
 - 2 = Cleaning in progress
 - 3 = Room cleaned
 - 4 = Room passed inspection
 - 5 = Room failed inspection
 - 6 = Cleaning skipped
 - 7 = Not for sale



RoomStatus

3. Dial the status code for the room. A three-digit code appears. The first digit indicates the occupancy status, the second the old cleaning status, and the third the new status.
4. Press the **Room Status** key.

Flexible Feature Codes (FFCs)

Use this table to keep track of the FFCs assigned by your system administrator.

	Call Detail Recording Charge Account		Make Set Busy Activate
	Call Forward All Calls Activate		Make Set Busy Deactivate
	Call Forward All Calls Deactivate		Malicious Call Trace
	Call Forward All Calls Verify		Override
	Internal Call Forward Activate		Radio Paging
	Internal Call Forward Deactivate		Radio Paging Access
	Remote Call Forward Activate		Radio Paging Answer
	Remote Call Forward Deactivate		Ring Again Activate
	Park Call		Ring Again Deactivate
	Park Call Access		Speed Call Controller
	Pickup Ringing Number		Speed Call User
	Pickup Group		System Speed Call User
	Pickup Directory Number		Station Control Password Change
	Electronic Lock Activate		Automatic Wake-Up Activate
	Electronic Lock Deactivate		Automatic Wake-Up Deactivate
	Group Call		Automatic Wake-Up Verify

Terms you should know

Attendant

A telephone operator in your organization.

Auto Dial

A telephone number programmed on the AutoDial key for one touch dialing.

Call party information

The display showing Call Party Name Display (CPND) information including the telephone number and name of the incoming call. The system must have CPND enabled.

Copy key

A Fixed key on the i2004 telephone that is reserved for future feature development. An audible non-working tone is generated along with a display message *Service not available* if this key is pressed.

Date/time display

The current date and time when the telephone is in an idle state.

Directory key

Enables access to the Corporate Directory.

Directory Number (DN)

A number consisting of one to seven digits for a telephone. Also known as an *extension number*.

Expand to PC

A Fixed key on the i2004 telephone that is reserved for future feature development. An audible non-working tone is generated along with a display message *Service not available* if this key is pressed.

Fastbusy

A signal given when all outgoing lines are busy.

Feature display

An area that shows status information about the feature in use. It also displays the name and status of the active session.

FFCs

See Flexible Feature Codes.

Fixed key

The hard labeled keys on your telephone.

Flexible Feature Codes (FFCs)

Specialized codes entered using the dial pad that enable features, for example Automatic Wake-Up call.

Handsfree

A method of conversing with the party on the other end of the line without lifting your handset.

Inbox (Message)

A Fixed key on the i2004 telephone that connects to your voice messaging system when the key is pressed.

Indicator

An LCD or an LED that indicates the status of a feature by the flash, wink, steady on, or off.

Information display

Any display of call activity, lists, prompts, and status of calls. On the i2004 telephone this information area is a one-line by twenty-four characters. If the text message exceeds this area, a scroll arrow icon indicates that you must use the scroll keys to view the remaining text.

Information line

A one-line by twenty-four character area which displays date and time or application information.

Interrupted dial tone

A broken or pulsed dial tone, heard when you access some of the features on your telephone.

Meridian 1

An office communications system.

More...

An option allowing access to the multiple layers of the Soft Feature keys. These keys are the four keys located directly below the display area.

Off-hook

Any line that is selected to either make a call or receive an incoming call. The term *off-hook* is applied, regardless of whether the end-user actually lifts up the handset, or presses a line key, or is automatically answered at the set, or a line is automatically selected for an outgoing call.

Paging tone

A special tone heard when using the Radio Paging feature. You hear two beeps followed by dial tone.

Primary Directory Number

The main extension number on your telephone. It is referred to by the Primary Directory Number (PDN) key.

Private Line

A feature that can be assigned to your telephone. With this line, you can reach an outside number without dialing a code to access an outside line. Internal extensions cannot be dialed from a private line.

Programmable Line (DN) /Feature Keys (self-labeled)

The six keys located at the sides of the upper area of the display.

Quit key

A Fixed key on the i2004 telephone that is used to exit applications.

Ringback/ring tone

A sound indicating that a call you have made is ringing at its destination.

Secondary Directory Number

A second incoming/outgoing line for your telephone.

Shared Directory Number

A DN (extension) that is shared by two or more persons.

Soft Keys (self-labeled)

A set of keys programmed by your system administrator. These four keys located directly below the display area have four programmable layers. The layers are accessed through the More... key. These keys are also used to configure parameters in the Telephone Option menu.

Special dial tone

The three consecutive tones followed by dial tone that you hear when accessing telephone features.

Status Messages

A message displayed to inform the user of important information. A right arrow appears if more than one Status Message is present. Examples of Status Messages include: Message Waiting, All Lines Forwarded to: 6453, Do Not Disturb On, Ring Again active, Ringer is OFF, and Line x Unavailable.

Succession Communication Server for Enterprise 1000

An office communications system.

System or Switch

Either Meridian 1 or Succession Communication Server for Enterprise 1000; your office communication system.

Switchhook

A button that the handset presses down, disconnecting your call when you replace the handset. The handset

(when lifted) releases the switchhook and you either answer an incoming call or you receive a dial tone to make a call.

User Interface

In this User Guide, User Interface refers to the display screen that interacts with the end-user as a result of an action or event.

A

Attendant 78
 Attendant Recall 38
 Auto Dial 30, 78
 Auto Dial Transfer 55
 Automatic Answerback 42
 Automatic Wake-Up 71

B

Buzz signal 55

C

Call Charge 40
 Call Forward 45
 Call Forward - Internal 46
 Call Join 50
 Call Page 56
 Call Page Connect 56
 Call Park 38
 Call party information 78
 Call Pickup 42
 Call timer 21
 Call Waiting 43
 Camp-on, Forced 33
 Centrex/Exchange Switchhook Flash 56
 Change Feature Key Label 9, 21
 Charge a call or Charge a Forced call 57
 Conference call 50
 Contrast Adjustment 9
 Contrast adjustment 17
 Copy Key 78
 CSE 1000 81

D

Date/time format 9, 18, 78
 Direct Inward System Access 48
 Directory 8, 27
 Directory Key 27, 78
 Directory Number 78
 Display 17, 18
 Display Diagnostics 9, 19
 Display incoming calls 40
 Display Key 40
 DN 78

E

Electronic Lock 48
 Enhanced Override Feature 59

F

Fastbusy 78
 Feature display 79
 Fixed key 79
 Flexible Feature Code (FFC) 42, 43, 45, 46,
 47, 48, 52, 54, 59, 79
 Forced Camp-on 33, 59

G

Goodbye Key 7, 26
 Group Call 52

H

Handsfree 26, 79
 Handsfree Button 26
 Headset Key 7, 27
 Hold 36

Hold Key 8

Hospitality features 71

Hot Line 33

I

i2004 Telephone display 11

Inbox (Message) 8, 79

Indicator status 79

Information display 79

Information line 79

Intercom call 34

Internal Call Forward 46

Interrupted dial tone 79

J

Join a call 50

L

Language 9, 18

Last Number Redial 32

Line (DN) Key 7

Local Dialpad Tone 9, 19

M

Maid Identification 74

Make Set Busy 54

Malicious call Trace 41

Meet - me page 61

Meridian One 80

Message Registration 73

More Key 9, 80

Mute 8, 26

N

Navigation Keys 8, 14

O

Off-hook 25, 80

On-hook 25

OnHook Default Path 9

On-hook dialing 29

Override 59, 60

P

Page Meet- me code 61

Paging tone 80

Password change 49

Predial Recall 29

Primary Directory Number 9, 80

Privacy Release 61

Private Line 80

Programmable Line (DN) / Feature Keys
(self-labeled) 9, 80

Q

Quit Key 8, 80

R

Radio Page 61

Record a Caller's Number 40

Redial last number called 32

Remote Call Forward 47

Ring Again 31

Ring Type 9, 20

Ringback/ring tone 60, 81

Room Status 75

S

- Secondary Directory Number 81
- Secure your telephone 48
- Selectable Conferee display and Disconnect 51
- Services 14
- Services key 9
- Set Information 9, 23
- Shared Directory Numbers 81
- Shift 8
- Soft Keys (self-labeled) 81
- Speaker Key 8
- Special dial tone 81
- Speed Call 32
- Speed Call, System 33
- Station Control Password 48, 49
- Status Messages 80, 81
- Succession Branch Office 69
- Succession Communication Server for Enterprise 1000 81
- Switchhook 81
- System or Switch 81
- System Speed Call 33

T

- Telephone Option 9
- Timed Reminder Recall 37
- Transfer a call 36

U

- User Interface 80, 82

V

- Virtual Office 9, 64
- Voice Call 63
- Volume Adjustment 9, 15
- Volume Control Bar 7

Meridian 1 and Succession Communication Server for Enterprise 1000
i2004 Internet Telephone User Guide

Copyright © 2002 Nortel Networks

All Rights Reserved

Information is subject to change without notice. Nortel Networks reserves the right to make changes in design or components as progress in engineering and manufacturing warrant. This equipment has been tested and found to comply with the limits for a Class A digital device pursuant to Part 15 of the FCC rules, and the radio interference regulations of the Industry Canada. These limits are designed to provide reasonable protection against harmful interference when the equipment is operated in a commercial environment. This equipment generates, uses and can radiate radio frequency energy, and if not installed and used in accordance with the instruction manual, may cause harmful interference to radio communications.

Operation of this equipment in a residential area is likely to cause harmful interference in which case the user will be required to correct the interference at their own expense.

SL-1, Meridian 1, and Succession are trademarks of Nortel Networks.

Publication Number: P1002469

Document Release: Standard 2.00

Date: November 2002

Printed in Canada



Internet address

<http://www.nortelnetworks.com>