



ShoreTel® 7.5

Planning and Installation Guide



Document and Software Copyrights

Copyright © 1998–2007 by ShoreTel, inc., Sunnyvale, California, U.S.A. All rights reserved. Printed in the United States of America. Contents of this publication may not be reproduced or transmitted in any form or by any means, electronic or mechanical, for any purpose, without prior written authorization of ShoreTel, Inc.

ShoreTel Inc. reserves the right to make changes without notice to the specifications and materials contained herein and shall not be responsible for any damage (including consequential) caused by reliance on the materials presented, including, but not limited to, typographical, arithmetic, or listing errors.

Trademarks

ShoreTel®, ShoreCare®, ShoreWare®, ShoreGear® and ControlPoint® are registered trademarks of ShoreTel, Inc. in the United States and/or other countries. ShorePhone™ is a trademarks of ShoreTel, Inc. in the United States and/or other countries. All other copyrights and trademarks herein are the property of their respective owners.

Patents

This product is covered by one or more of the following patents: United States Patent 6,996,059, United States Patent 7,003,091. ShoreTel, Inc. All rights reserved.

Version Information

ShoreTel 7.5 Planning and Installation Guide
Revision 3
Part Number: 800-1030-07
Date: August 27, 2007

Company Information

ShoreTel, Inc.
960 Stewart Drive
Sunnyvale, California 94085

(408) 331-3300
(408) 331-3333 fax

www.shoretel.com

Contents

PREFACE

- Objectives Preface-xiii
- Audience Preface-xiii
- Organization Preface-xiii
- Documentation Preface-xiii
 - System Documentation Preface-xiii
 - Software Documentation Preface-xiv
 - Hardware Documentation Preface-xiv
 - User Documentation Preface-xiv
 - Online Knowledge Base—ShoreLink Preface-xv
- Document Conventions Preface-xv

Part I: Introduction

CHAPTER 1: GETTING STARTED

- Checklist 1-1
- Recommendations 1-2
- Assembling the Team 1-2
- ShoreCare ControlPoint 1-3
 - Phase 1: Voice Communications System Analysis and Ordering 1-3
 - Phase 2: Environmental and Infrastructure Analysis and Upgrade 1-4
 - Phase 3: Resource Scheduling and Tracking 1-5
 - Phase 4: System Load and Configuration 1-6
 - Phase 5: Installation Readiness Review 1-6
 - Phase 6: Cut-Over 1-7

CHAPTER 2: SYSTEM OVERVIEW

- Checklist 2-1
- ShoreTel Distributed IP Voice Architecture 2-2
- Distributed Call Control 2-2
 - Distributed Routing Service 2-3
- Distributed Applications Platform 2-3
- Single System Management 2-4
 - Multi-level Management 2-4
- System Reliability 2-4
 - Distributed Switch Control 2-5
 - Embedded IP Phone Display 2-5
 - IP Phone Keep Alive 2-5
 - IP Phone Failover 2-5
 - Public Switched Telephone Network (PSTN) Failover 2-6
 - Distributed CDR 2-6
- Integrated Applications 2-7
 - Account Codes 2-7
 - Voice Mail 2-7
 - Automated Attendant 2-8
 - Hunt Groups 2-9
 - Workgroups 2-9
 - Pickup Groups 2-11
 - Queue Monitor 2-11
 - Agent Monitor 2-11
 - Directory Viewer 2-11
 - History Viewer 2-11
 - Call Detail Record (CDR) 2-11

Desktop Call Control Service	2-12
Unified Messaging Service	2-12
Optional Applications	2-12
ShoreTel Converged Conference Solution	2-12
ShoreTel Contact Center Solution	2-13
ShoreWare System Monitor	2-14
Desktop Applications	2-14
Personal Call Manager	2-15
Advanced Call Manager	2-15
Workgroup Agent Call Manager	2-15
Workgroup Supervisor Call Manager	2-15
Operator Call Manager	2-15
SoftPhone	2-15
Web Access	2-16
Office Anywhere™	2-16
Voice Switches	2-16
ShoreGear-120/24	2-16
ShoreGear 90	2-17
ShoreGear 90BRI	2-17
ShoreGear-60/12	2-17
ShoreGear 50	2-17
ShoreGear-40/8	2-17
ShoreGear-T1	2-17
ShoreGear-E1	2-18
ShoreGear 220T1	2-18
ShoreGear 220T1A	2-18
ShoreGear-220E1	2-18
ShoreTel IP Phones and Devices	2-19
ShorePhone-AP100	2-19
ShorePhone-IP100	2-19
ShorePhone-IP110	2-19
ShorePhone-IP115	2-20
ShorePhone-IP210	2-20
ShorePhone-IP212k	2-20
ShorePhone-IP230	2-21
ShorePhone-IP530	2-21
ShorePhone-IP560	2-22
ShorePhone-IP560g	2-22
ShorePhone-BB24	2-23
System Capacity	2-25
Extension Monitoring Limitations	2-27
ShoreGear Voice Switch Feature Capacity	2-28

Part II: Conceptual Planning and System Design

CHAPTER 3: PLANNING AND SYSTEM DESIGN

Checklist	3-1
Recommendations	3-1
Determine System Topology	3-2
Sites and Users	3-2
Headquarters and Distributed ShoreWare Servers	3-2
Citrix and Windows Terminal Server	3-3
Teleworker Sites	3-3
Telephone Requirements	3-3
Trunk Requirements	3-5
Determine Number of ShoreGear Voice Switches	3-6
WAN Connections	3-7

CHAPTER 4: ROUTING CALLS

Recommendations	4-2
---------------------------	-----

Hunt Groups	4-2
Direct All Calls to an Auto-Attendant	4-3
Trunk Considerations	4-3
After-Hours Call Routing	4-3
Example of Auto-Attendant Call Routing	4-3
Direct All Calls to a Live Operator.	4-6
Trunk Considerations	4-6
After-Hours Call Routing	4-7
Example Using Hunt Groups	4-7
Example of Operator Call Routing	4-7
Direct All Calls to Extensions.	4-9
Trunk Considerations	4-9
After-Hours Call Routing	4-9
Example of Direct Inward Dial Call Routing.	4-9
Blended Call Routing	4-11
Trunk Considerations	4-11
After-Hours Call Routing	4-11
Example of Blended Call Routing	4-11
Analyze Outbound Call Routing	4-13

CHAPTER 5: TRUNK PLANNING AND ORDERING

Checklist	5-1
Recommendations.	5-1
Reviewing and Selecting Trunk Types.	5-2
Analog Loop-Start Trunks (North America)	5-2
Analog Loop-Start Trunks (EMEA)	5-3
Digital Loop-Start Trunks	5-4
Analog Wink-Start Trunks (Analog DID).	5-4
Digital Wink-Start Trunks	5-4
BRI Trunks	5-5
PRI Trunks.	5-5
E1 PRI Trunks	5-6
SIP Trunks.	5-6
Understanding Trunk Features	5-7
Caller ID Number.	5-7
Caller ID Name.	5-8
Automatic Number Identification (ANI)	5-8
Direct Inward Dial (DID)	5-9
Dialed Number Identification Service (DNIS).	5-9
Outbound Caller ID	5-10
Tandem Trunking.	5-10
Tie Trunks.	5-10
Performing Traffic Calculations	5-10
Ordering Telephone Service.	5-12
Analog Service	5-13
T1 Service.	5-14
T1 PRI Service.	5-15
Ordering Service	5-15
E1 PRI Service	5-15

CHAPTER 6: DIALING PLAN

Overview	6-1
Checklist	6-1
Define Digit Collection	6-2
Configuring Internal Numbers	6-2
Configuring External Numbers	6-4
Dialing from the ShoreWare Call Manager	6-8
Define Digit Manipulation.	6-10
On-Net Dialing	6-11
Configuration	6-13

Quick Reference of Star Codes	6-18
Common Star Codes	6-18
Office Anywhere Star Codes	6-18
Trunk Star Codes	6-19
CHAPTER 7: NETWORK CALL ROUTING	
Overview	7-1
Checklist	7-1
Define Network Call Routing.	7-2
Call Permissions	7-2
Account Codes.	7-3
Trunk Availability	7-4
Specifying Parameters for the Routing Decision	7-5
CHAPTER 8: TELEPHONE PLANNING AND ORDERING	
Checklist	8-1
Recommendations.	8-1
Application Considerations.	8-2
General Users.	8-2
Workgroup Agents and Supervisors	8-2
Operators.	8-2
Receptionists	8-2
Conference Rooms.	8-3
Lobby Phones	8-3
Multi-line Phones	8-3
Teleworkers	8-3
Fax Machines and Modems	8-3
Fax Machines	8-3
Modems.	8-4
ShorePhone Telephones.	8-4
ShorePhone-AP100	8-4
ShorePhone-IP110/115/210/212k/230/530/560/560g	8-4
Analog Phone Requirements.	8-5
CHAPTER 9: NETWORK REQUIREMENTS AND PREPARATION	
Checklist	9-1
Overview	9-2
Advantages of Voice Over IP	9-2
Understanding the Requirements for Toll-Quality Voice	9-3
Network Requirements	9-3
Bandwidth Requirements.	9-3
Latency.	9-10
Jitter for Voice Switches.	9-10
Packet Loss.	9-11
Bandwidth Management	9-12
Admission Control in the Wide Area Network.	9-14
Spanning Tree Protocol	9-14
Traffic Shaping to Reduce Bottlenecks	9-14
Echo Cancellation	9-14
Resultant Voice Quality	9-15
WAN Technology Choices	9-17
Minimum Bandwidth Requirements.	9-17
Leased T1.	9-17
Frame Relay	9-17
SDSL.	9-18
IDSL	9-18
ADSL	9-18
Cable Modems.	9-18
ISDN BRI.	9-18
Dial-Up Modems	9-18

IP Address Assignment	9-18
Configuring DHCP for ShoreTel IP Phones	9-20
Configuring Automatic VLAN Assignment via DHCP	9-22
Time Services	9-23
Virtual Private Network (VPN)	9-24
Tunneling	9-25
Encryption	9-26
Performance	9-26
Integrated Security Appliances	9-26
Firewalls	9-27
Media Encryption	9-29
Session Initiation Protocol (SIP)	9-30
Example Network Topologies	9-31
Single-Site Implementation	9-31
Multisite Implementation	9-32
Computing Admission Control Bandwidth	9-33
Setting Admission Control	9-36

CHAPTER 10: SERVER REQUIREMENTS

Checklist	10-1
Recommendations	10-1
Hardware Requirements	10-2
Hard Disk Space Utilization	10-3
Voice Mail	10-3
Call Detail Records	10-4
Log Files	10-4
Software Requirements	10-4
Additional Considerations	10-5
Terminal Services	10-5
Adobe Acrobat Reader	10-5
DHCP on the ShoreWare Server	10-5
Server Computer Name	10-5
Server IP Address	10-5
Internet Information Server (IIS) Default Web Site	10-5
Access to the Distributed Server Maintenance Page	10-6

CHAPTER 11: PLANNING APPLICATIONS AND SERVICES

Checklist	11-1
Account Code Collection Service	11-2
Account Codes	11-2
Call Permissions	11-2
Voice Mail	11-3
Escalation Notifications	11-4
Auto-deletion of Voice Mail Messages	11-4
Mailbox Full Notifications	11-4
Distributed Voice Mail	11-4
AMIS Protocol Support	11-5
SMDI Protocol Support	11-5
Find Me Call Handling	11-6
Call Sender	11-7
Time Stamps	11-7
Planning Fax Handling	11-8
Using a Fax Server	11-9
Private Numbers	11-17
Automated Attendant	11-18
Call Handling Delegation	11-18
Web Access	11-19
Bridged Call Appearances	11-19
Hunt Groups	11-20

Hunt Group Busy State	11-20
Configurable Hunting	11-21
Hunt Group Applications	11-21
Pickup Groups	11-22
Workgroups	11-24
Agent Multiplicity	11-24
Call Monitor and Barge In	11-24
ShoreWare Call Manager	11-26
SoftPhone	11-27
Enterprise Telephony Features	11-28
Music on Hold	11-28
Overhead Paging	11-29
Paging Groups	11-29
Night Bell	11-29
Intercom	11-29
Call Recording	11-30
Make Me Conferencing	11-31
ShoreTel Conference Bridge	11-31
Dialing the Conference Bridge	11-31
ShoreTel Contact Center Solution	11-33

CHAPTER 12: DESKTOP REQUIREMENTS

Checklist	12-1
Recommendations	12-1
Hardware Requirements	12-2
Additional Space for Upgrading	12-2
Software Requirements	12-3
Network Requirements	12-3
Citrix and Windows Terminal Server	12-3

CHAPTER 13: SITE REQUIREMENTS AND PREPARATION

Checklist	13-1
Recommendations	13-2
Switch Models	13-2
Voice Switch Requirements	13-3
Physical Requirements	13-3
Input Power	13-4
Power and Heat Dissipation	13-5
Environmental Requirements	13-6
Reliability and Availability	13-6
Memory and Processing	13-7
Connectors	13-7
ShoreGear-120/24 Connectors	13-10
ShoreGear 90 Connectors	13-11
ShoreGear 90BRI Connectors	13-12
ShoreGear-60/12 Connectors	13-13
ShoreGear 50 Connectors	13-14
ShoreGear-40/8 Connectors	13-14
ShoreGear-T1 Connectors	13-15
ShoreGear-E1 Connectors	13-15
ShoreGear 220T1 Connectors	13-16
ShoreGear 220E1 Connectors	13-17
ShoreGear 220T1A Connectors	13-18
Racks and Cabling	13-19
General Cabling Overview	13-19
Rack Overview	13-20
Connector Pinouts	13-21
ShoreGear-120/24 RJ-21X Telephone and Trunk Connector	13-21
ShoreGear 90 RJ-21X Telephone and Trunk Connector	13-23

ShoreGear 90BRI RJ-21X Telephone and Trunk Connector	13-25
ShoreGear-60/12 RJ-21X Telephone and Trunk Connector	13-26
ShoreGear-60/12 RJ-21X Telephone and Trunk Connector with Converter Patch Cable	13-28
ShoreGear 50 RJ-21X Telephone and Trunk Connector	13-30
.....	13-31
ShoreGear-40/8 RJ-21X Telephone and Trunk Connector	13-31
ShoreGear-40/8 RJ-21X Telephone and Trunk Connector with Patch Cable	13-33
ShoreGear 220T1A RJ-21X Telephone and Trunk Connector	13-35
RJ-11 Telephone and Trunk Connector	13-37
RJ-45 LAN Connector	13-37
3mm Stereo Audio Input Connector for Music on Hold	13-37
3mm Stereo Audio Output Connector for Paging/Nightbell	13-37
RJ-48C T1/E1 and T1/E1 Monitor Connectors	13-39
DB-9 Maintenance Connector	13-39
Headset Jack Connector (IP530/560)	13-40

CHAPTER 14: LEGACY INTEGRATION

Checklist	14-1
Introduction	14-2
Coordinated Dialing	14-2
Trunk Requirements	14-4
Coordinated Dialing Plan	14-4
PSTN Services	14-5
Multi-Site Integration	14-5
Single Site Integration	14-5
Consolidated Long Distance	14-6
Voice Mail Integration	14-6
AMIS Protocol Support	14-6
SMDI Protocol Support	14-7
Configuring Legacy Voice Mail Integration Using SMDI	14-11
Configuring ShoreTel Voice Mail Integration Using SMDI	14-19
System Requirements	14-28
Connection Cable	14-28
Special Considerations - Nortel PBX	14-28
Special Considerations - Avaya/Lucent PBX	14-28
Administration and Configuration	14-29
Tie Trunk Configuration	14-29
Services Summary	14-29
Trunk Configuration	14-30

Part III: Installation and Configuration Process

CHAPTER 15: IP PHONE INSTALLATION

Checklist	15-1
Recommendations	15-2
Preparing Your ShoreTel System for IP Phones	15-2
Configuring Voice Switches for IP Phone Support	15-2
Configuring Teleworker IP Phones	15-2
Assigning the Configuration Switches	15-3
Setting IP Address Ranges	15-4
DHCP Settings	15-5
Associating a User Group with Unassigned IP Phones	15-6

CHAPTER 16: INSTALLING SHOREGEAR VOICE SWITCHES

Checklist	16-1
Planning	16-1
Mounting the ShoreGear Voice Switches	16-2
Installing SG-40/8, SG-50, SG-60/12, SG-90, SG-120/24 Voice Switches	16-3

Installing SG-T1/E1, SG-220T1/T1A/E1 Voice Switches	16-4
RJ-21X Cable Retainer Installation	16-5
ShoreWare Director Switch Configuration	16-5
Adding a ShoreGear-120/24, ShoreGear 90, ShoreGear-60/12, ShoreGear 50, or ShoreGear-40/8	16-5
Adding a ShoreGear-T1 or ShoreGear-220T1/T1A	16-6
Reference	16-7
Environmental Requirements	16-7
Packaging Requirements	16-8
Regulatory Compliance	16-8
Physical Specifications	16-9
General Specifications	16-9

CHAPTER 17: SERVER INSTALLATION

Checklist	17-1
Installing Microsoft Windows Server 2003 Components	17-2
Installing Software on the Main Server	17-3
Upgrading Software on the Headquarters Server	17-9
Installing Software on a Distributed Server	17-10
Notes About Upgrading Software on the Distributed Server	17-15
Ensuring Proper Server Performance	17-16

CHAPTER 18: DESKTOP INSTALLATION

Checklist	18-1
Recommendations	18-1
Notifying Users via Email	18-2
Installation Procedure	18-2
Silent Client Upgrade	18-2
Standard Integrated Software Distribution Overview	18-3
Installing the ShoreWare Call Manager Software	18-4
Configure the TAPI Dialing Parameters	18-8
Starting the ShoreWare Call Manager Application	18-9
Configuring SoftPhone	18-9
Installing Outlook Integration	18-12
Installing Voice Mail Integration	18-12
Installing Automatic Call Handling	18-14
Memorized Phone Number Management	18-14
Upgrade Procedures	18-15
User Licensing	18-16
Purchasing User Licenses	18-16
Language Licenses	18-16
License Control	18-17
Other Considerations	18-18
Windows Accounts and the ShoreWare Call Manager	18-18
Changing the Server Name	18-18

Part IV: Managing Cut-Over

CHAPTER 19: CUT-OVER

Checklist	19-1
Cut-Over Requirements	19-2
Cut-Over Worksheet	19-2
New Trunks	19-2
Cut-Over Coverage	19-2
Cut-Over Implementation	19-2
Basic Cut-Over Checklist	19-3
Trunking Cut-Over	19-3
Cut-Over of Remaining Devices	19-4
Cut-Over Coverage	19-4
Cut-Over Worksheet	19-5

CHAPTER 20: TRAINING

Checklist	20-1
Recommendations	20-2
Training Materials	20-2
End-User Training	20-2
Operator Training	20-2
Workgroup Training	20-4
System Administrator Training	20-4

Part V: Reference and Appendixes

APPENDIX A: INTERNATIONAL PLANNING AND INSTALLATION

Software and Feature Support	A-1
Call Managers	A-3
Desktop Operating System	A-3
Language Packs	A-3
Analog Caller ID Support	A-7
Hardware Support	A-8
Voice Switches	A-8
International Trunking	A-8
Analog Telephones, Tones, Cadences, and Impedances	A-8
Hardware Availability Summary	A-9
Summary	A-12
Dialing Plan Considerations	A-14
Single-Extension Plan	A-14
Trunk Access Codes	A-14
Operator Digit	A-14
Emergency Numbers	A-14
DID Numbers	A-15

APPENDIX 2: REGULATORY AND SAFETY INFORMATION

Agency Approvals	B-1
EMC Compliance Statements (SG-8/12/24 and T1)	B-2
United States	B-2
European Union	B-3
Canada	B-3
Restricted Access Location	B-3
WEEE Information	B-3
Safety	B-3
Important Safety Instructions	B-3
Electrical Safety	B-4

APPENDIX C: SHOREGEAR IPBX VOICE SWITCHES

Voice Switch Requirements	C-3
Physical Requirements	C-3
Input Power	C-3
Power and Heat Dissipation	C-3
Environmental Requirements	C-4
Reliability and Availability	C-4
Connectors	C-4
ShoreGear-24 Connectors	C-8
ShoreGear-12 Connectors	C-9
ShoreGear-Teleworker Connectors	C-10
ShoreGear-T1 Connectors	C-11
Racks and Cabling	C-12
General Cabling Overview	C-12
Rack Overview	C-13
Connector Pinouts	C-14
ShoreGear-24 RJ-21X Telephone and Trunk Connector	C-14

ShoreGear-12 RJ-21X Telephone and Trunk Connector	C-16
RJ-11 Telephone and Trunk Connector	C-18
RJ-45 LAN Connector	C-18
3mm Mono Audio Input and Output Connectors	C-18
RJ-48C T1 and T1 Monitor Connectors	C-19
DB-9 Maintenance Connector	C-19

APPENDIX D: IP PHONE CONFIGURATION

Manually Configuring the ShorePhone-IP100	D-1
Rebooting the ShorePhone-IP100	D-1
Navigating the Phone Menu	D-2
Menu Options	D-3
Manually Configuring the ShorePhone-IP110/115/210/212k/230/530/560/560g and BB24	D-4
Displaying ShorePhone-IP110/115/210/212k/230/530/560/560g Settings.	D-6
Resetting the ShorePhone-IP110/115/210/212k/230/530/560/560g	D-6

APPENDIX E: ENABLING INTERNET ACCESS TO SHORETEL WEB ACCESS

Overview	E-1
Requirements	E-1
Installation and Configuration	E-2
Example 1:	E-2
Example 2:	E-3
About the httpd.conf file	E-3

APPENDIX F: SHOREWARE CLIENTS ON CITRIX AND WINDOWS TERMINAL SERVERS

Overview	F-1
Installing Call Manager on WTS or Citrix Platforms	F-1
Citrix Application Mode	F-5
Configuring Other TAPI Applications	F-5

APPENDIX G: SESSION INITIATION PROTOCOL

Overview	G-1
Supported RFCs.	G-2
General SIP Comments	G-2
Configuration	G-6
Configuring the ShoreTel System via Director.	G-6
Configure the SIP Device	G-14

GLOSSARY

INDEX

Preface

This preface provides information about the objectives, organization, and conventions of the *ShoreTel 7.5 Planning and Installation Guide*.

Objectives

This document provides planning and installation information for the ShoreTel 7.5 system and components.

Audience

This guide is written for the person who plans, installs, administers, and maintains the ShoreTel 7.5 system. This individual should be knowledgeable about data networking and telephony to use this guide effectively.

Organization

This document is generally organized into major tasks, presented in the order in which they should be completed.

Documentation

The ShoreTel 7.5 system is documented as described in the following sections.

System Documentation

The *ShoreTel 7.5 Planning and Installation Guide* (this guide) can be found in the documentation folder on the ShoreWare DVD and can also be accessed from ShoreWare Director.

This guide provides information on how to plan the implementation of the ShoreTel 7.5 system, as well as how to install the necessary hardware, data communications, and telecommunications elements. The *ShoreTel 7.5 Planning and Installation Guide* can be used in conjunction with the ShoreCare[®] ControlPoint project management tool.

Software Documentation

The *ShoreTel 7.5 Administration Guide* provides detailed reference information (both task-based and screen-by-screen) on how to administer and maintain the ShoreTel 7.5 system using ShoreWare Director. If you are installing one or more ShoreTel Conference Bridges, refer to the *ShoreTel Converged Conference Solution Administration Guide* for complete installation and configuration information. Both guides can be found in the documentation folder on the DVD.

The following release notes can be found in the documentation folder on the associated DVD and may also be accessed from ShoreWare Director:

- *Server Release Notes* provide information about new releases, new features, installation, and upgrading for the ShoreWare server.
- *Call Manager Release Notes* provide information about new releases, new features, installation, and upgrading for the ShoreWare Call Manager.

Hardware Documentation

The following hardware installation documents are packaged with the associated ShoreGear voice switch or conferencing bridge:

- *ShoreGear-120/24 Quick Install Guide*
- *ShoreGear-90 Quick Install Guide*
- *ShoreGear-60/12 Quick Install Guide*
- *ShoreGear-50 Quick Install Guide*
- *ShoreGear-40/8 Quick Install Guide*
- *ShoreGear-T1 Quick Install Guide*
- *ShoreGear-E1 Quick Install Guide*
- *ShoreGear-220T1 Quick Install Guide*
- *ShoreGear-220E1 Quick Install Guide*
- *ShoreTel Conference Bridge Quick Install Guide*

In addition, the following telephone documents are available:

- *ShorePhone-AP100 Quick Install Guide*
- *ShorePhone-IP100 Quick Install Guide*
- *ShorePhone-IP110 Quick Install Guide*
- *ShorePhone-IP115 Quick Install Guide*
- *ShorePhone-IP210 Quick Install Guide*
- *ShorePhone-IP212k Quick Install Guide*
- *ShorePhone-IP230 Quick Install Guide*
- *ShorePhone-IP530/560/560g Quick Install Guide*
- *ShorePhone-BB24 Quick Install Guide*

User Documentation

End-user documentation is installed during the ShoreWare Call Manager installation. It is available through the **Help > Contents and Index** command within the ShoreWare Call Manager application.

- *Analog Phone Quick Reference*, which is available in the telephone user interface
- *IP Phone Quick Reference*, which is available in the telephone user interface

Online Knowledge Base—ShoreLink

To access additional information about the current release or to resolve issues with the ShoreTel 7.5 system, you can use ShoreLink, the ShoreTel online knowledge base. This password-protected, online database is accessible to authorized contacts through the ShoreTel web site at www.ShoreTel.com.

Document Conventions

Conventions used in this guide include the following:

- Data-entry field names, hypertext links, control buttons, keywords, and other items within the system management interface are in **boldface** text.
- Information that you enter in data-entry fields is in a `data_entry` font.
- **NOTE** indicates an area of special interest to the user.

Part I: Introduction

C H A P T E R 1

Getting Started

Congratulations on your purchase of the ShoreTel 7.5™ system!

Highly flexible, your new ShoreTel 7.5™ system is also simple to install, administer, and maintain. You will be able to unify all your locations and voice applications into a single, efficient voice communications network.

Voice communications is a mission-critical application. This planning and installation guide leads you through the installation process to a successful implementation, so that you and your user community can enjoy the benefits of the ShoreTel 7.5 system.

Each chapter in this guide begins with recommendations that help you make a smooth transition to the ShoreTel 7.5 system.

NOTE If you are planning an international deployment, please see Appendix A, “International Planning and Installation,” for the international capabilities of the ShoreTel 7.5 system.

Checklist

Review the following topics before proceeding to the next chapter:

Task Description	See
<input type="checkbox"/> Recommendations	page 1-2
<input type="checkbox"/> Assembling the Team	page 1-2
<input type="checkbox"/> ShoreCare ControlPoint	page 1-3

Recommendations

The following recommendations help ensure that your planning and installation of the ShoreTel 7.5 system proceeds smoothly.

- **Resource planning:** Do not underestimate the amount of resource commitment needed to successfully implement a mission-critical application such as a new voice communications system.
- **Schedule planning:** Likewise, do not underestimate the amount of time needed to successfully implement the system. Plan necessary tasks ahead of time. Many tasks have long lead times (for example, ordering telephone service, preparing cabling, and ordering telephones), and unforeseen problems can arise that must be resolved.
- **Delegation:** Do not try to do everything yourself. Make sure you assign the right resources to the right task.
- **Communication:** Make sure you communicate with the key members of your organization and determine their individual and departmental needs (whether workgroups, operators, assistants, or executives). Make sure they support any decision that affects their respective areas.

Once the system is successfully deployed, you need to establish clear ownership of the voice communications system. Not only will you want to adapt the system to your changing corporate needs, but you also need to account for the interaction between your data network and your voice application. When changes are made to the data network (for example, renumbering your IP addresses or changing your backbone), you need to consider the impact on your voice communications system, and plan accordingly.

Assembling the Team

To deploy the ShoreTel 7.5 system successfully, you need to assemble a team. The key members of the team include, but are not limited to:

- **Project Manager:** Someone needs to oversee the entire project to make sure that key decisions are made and communicated to the entire team, deadlines are met, and issues are resolved. This is typically an IT manager.
- **System Designer:** Someone needs to take ownership of the design of the system, including the number of telephones, number of trunks, and desired call flow. This person is also responsible for the day-to-day system administration after the cut-over to the new system. This is typically a member of the IT staff.
- **IT Manager:** You need the full support and cooperation of your IT department, since the ShoreTel 7.5 system is a new application on your data network, interacting with servers, desktops, the IP address space, switches, routers, and so on.
- **Cabling Contractor:** You may need to hire a cabling contractor to install racks and cabling, as well as to place and test telephones.
- **Electrical Contractor:** You may need to hire an electrician to install new power outlets, and potentially some cooling and ventilation systems.
- **Service Providers:** You should establish a relationship with a telephone service provider for local and long-distance telephone service. You also need to work with a network service provider to provide IP connectivity between multiple locations, if you have multiple sites.

- **ShoreTel:** Depending on what type of installation and support package you purchased, ShoreTel, or a certified ShoreTel partner, may be involved in your implementation.

ShoreCare ControlPoint

Installation services are built around ShoreCare ControlPoint, an interactive, web-based project management tool that allows you to take complete control of the installation process. ShoreCare ControlPoint provides real-time visibility into each step of the system installation, from initial needs assessment and resource planning to the final step of going live with the new voice system. It also lets you simultaneously manage installations at multiple sites.

This planning and installation guide can be used in conjunction with ShoreCare ControlPoint. ShoreCare ControlPoint provides step-by-step checklists for each phase of installation and cut-over.

Phase 1: Voice Communications System Analysis and Ordering

<input type="checkbox"/>	Download and modify the Microsoft Project installation schedule included in Resources	
<input type="checkbox"/>	Complete Call Flow Analysis	
<input type="checkbox"/>	Inventory and determine trunk requirements	
<input type="checkbox"/>	Order new trunk lines	
<input type="checkbox"/>	Trunk installation date	Date: <input type="text"/>
<input type="checkbox"/>	Inventory your existing telephone equipment	
<input type="checkbox"/>	Order new phones and/or headsets	
<input type="checkbox"/>	Review your need for a ShoreTel Conference Bridge	
<input type="checkbox"/>	Order a ShoreTel Conference Bridge	
<input type="checkbox"/>	Review your need for a ShoreTel Contact Center Solution	
<input type="checkbox"/>	Order a ShoreTel Contact Center Solution	
<input type="checkbox"/>	Order ShoreGear voice switches	
<input type="checkbox"/>	ShoreGear shipping date	Date: <input type="text"/>

Phase 2: Environmental and Infrastructure Analysis and Upgrade

<input type="checkbox"/>	Participate in the Phase 2 conference call	
<input type="checkbox"/>	Read ShoreTel's power requirements	
<input type="checkbox"/>	Order power upgrades (as necessary)	
<input type="checkbox"/>	Scheduled power upgrade completion date	Date: <input type="text"/>
<input type="checkbox"/>	Read ShoreTel's racking requirements	
<input type="checkbox"/>	Racking installation date (if racking is ordered)	Date: <input type="text"/>
<input type="checkbox"/>	Read ShoreTel's ventilation requirements	
<input type="checkbox"/>	Ventilation system upgrade completion date (if ordered)	Date: <input type="text"/>
<input type="checkbox"/>	Read ShoreTel's recommendations for Uninterruptable Power Source (UPS)	
<input type="checkbox"/>	UPS installation date (if ordered)	Date: <input type="text"/>
<input type="checkbox"/>	Read ShoreTel's cabling requirements	
<input type="checkbox"/>	Cabling installation date (if ordered)	Date: <input type="text"/>
<input type="checkbox"/>	Determine your overhead paging needs	
<input type="checkbox"/>	Source your Music on Hold needs	
<input type="checkbox"/>	Read ShoreTel's LAN requirements	
<input type="checkbox"/>	Attach LAN topology map	
<input type="checkbox"/>	LAN installation date (if ordered)	Date: <input type="text"/>
<input type="checkbox"/>	Read ShoreTel's WAN requirements	
<input type="checkbox"/>	Attach WAN topology map	
<input type="checkbox"/>	WAN upgrade installation date (if ordered)	Date: <input type="text"/>
<input type="checkbox"/>	Read ShoreTel's server requirements	
<input type="checkbox"/>	Order your server for the ShoreTel System	
<input type="checkbox"/>	Server installation date	Date: <input type="text"/>
<input type="checkbox"/>	Read ShoreTel's desktop requirements	
<input type="checkbox"/>	Desktop software upgrade installation date (if required or ordered)	Date: <input type="text"/>
<input type="checkbox"/>	ShoreGear scheduled installation date	Date: <input type="text"/>

Phase 3: Resource Scheduling and Tracking

-
- Participate in the Phase 3 conference call

 - Verify Telco order is on schedule

 - Verify phone order is on schedule

 - Verify power order is on schedule

 - Verify racking order is on schedule

 - Verify ventilation order is on schedule

 - Verify Uninterruptable Power Source (UPS) order is on schedule

 - Verify cabling order is on schedule

 - Verify LAN upgrade order is on schedule

 - Verify WAN upgrade order is on schedule

 - Verify desktop upgrade order is on schedule

 - Verify ShoreGear order is on schedule

 - Read ShoreTel's descriptions of the different Call Manager applications

 - Schedule your System Administration training with ShoreTel

 - Order new business cards and business stationary if your phone numbers are changing

 - Verify that you have obtain all licenses and license keys for your planned installation.
-

Phase 4: System Load and Configuration

-
- Participate in the Phase 4 conference call

 - Verify receipt of ShoreGear equipment

 - Reserve IP addresses for your network

 - Configure server with the appropriate server operating system

 - Load the ShoreGear software

 - Enter the database configuration for ShoreGear

 - Confirm your ShoreTel System installation and cut-over dates

 - Confirm installation and cut-over coverage

 - Verify racking is complete

 - Verify power is in compliance

 - Verify UPS is installed

 - Verify cabling is complete

 - Verify ventilation upgrade is complete

 - Verify new phones and headsets have been delivered

 - Verify your System Administrators have been trained

 - Schedule training for your Operators and Workgroup(s)

Phase 5: Installation Readiness Review

-
- Participate in the Phase 5 conference call

 - Upgrade desktops, if necessary, and ensure readiness for ShoreTel Client software installation

 - Notify users of the ShoreTel 7.5 system implementation

 - Verify telephone trunk lines are installed and tested

 - Verify conference bridge is installed

 - Configure all on-hour and off-hour schedules for Auto-Attendant menus and Workgroups

 - Configure your Workgroups

 - Configure your Auto-Attendant menus

 - Script and record all Auto-Attendant and department voice mail greetings

Phase 6: Cut-Over

-
- Participate in the Phase 6 conference call

 - Complete your Cutover Review Checklist

 - Send web-based training modules to End Users

 - Send TUI guides to End Users

 - Verify that Operators are trained

 - Verify that Workgroups are trained

 - Verify that all phones have been placed and extensions tested

 - Verify that existing trunk lines have been swapped and tested

 - Verify that End Users have been sent the ShoreTel Client notification

 - Cut-over to the ShoreTel System

 - Complete your Post Cut-over Survey

 - Review the ShoreLink Web Center to understand the ShoreTel Support resources available

C H A P T E R 2

System Overview

This chapter presents an overview of the ShoreTel 7.5 system, including a description of the system capacity, to guide you in planning your solution.

Checklist

Review the following topics before proceeding to the next chapter:

Task Description	See
<input type="checkbox"/> ShoreTel Distributed IP Voice Architecture	page 2-2
<input type="checkbox"/> Distributed Call Control	page 2-2
<input type="checkbox"/> Distributed Applications Platform	page 2-3
<input type="checkbox"/> Single System Management	page 2-4
<input type="checkbox"/> Integrated Applications	page 2-7
<input type="checkbox"/> Desktop Applications	page 2-14
<input type="checkbox"/> Voice Switches	page 2-16
<input type="checkbox"/> ShoreTel IP Phones and Devices	page 2-19
<input type="checkbox"/> System Capacity	page 2-25

ShoreTel Distributed IP Voice Architecture

The ShoreTel 7.5 system is a completely distributed voice communication solution with no single point of failure, which is layered on top of your IP network. At the heart of the system is the standards-based Distributed IP Voice Architecture (Figure 2-1), which uniquely distributes call control intelligence to voice switches connected anywhere on the IP network. In addition, the Distributed IP Voice Architecture distributes voice applications, including voice mail systems and automated attendants, to servers across locations, rather than centralizing applications at the network core.

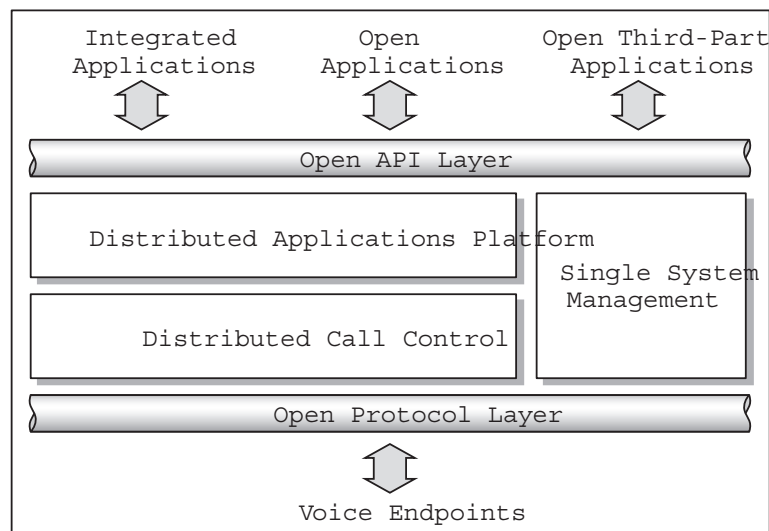

Figure 2-1 The Distributed IP Voice Architecture of the ShoreTel 7.5 System

The resulting solution provides a single image system for all locations and all voice applications. Multiple PBXs, voice mail systems, automated attendants, or ACD systems—each with their own dedicated management interface—are phone systems of the past. The ShoreTel 7.5 system is distributed, the voice applications are bundled, and the management interface is integrated.

Distributed Call Control

The heart of the ShoreTel 7.5 system is the distributed call control software, which runs on the ShoreGear voice switches on top of VxWorks,TM a real-time operating system. Each call control element manages the call setup and call teardown, including features such as transfer, conference, forward, call permissions, and call routing. The voice switches communicate on a peer-to-peer basis, eliminating any single point of failure. For instance, if one ShoreGear voice switch goes offline, all other ShoreGear voice switches continue operating. When the voice switch comes back online, it rejoins the voice network with no impact on system operation. There is no server involved with the basic telephony, so the system delivers levels of availability unmatched by even legacy vendors.

Distributed Routing Service

Distributed Routing Service (DRS) allows larger systems to scale beyond 60 switches up to a total of 200 switches (including SoftSwitches). The Distributed Routing Service is optional on systems up to 60 switches, but must be enabled on systems with 60 or more switches.

When the Distributed Routing Service is disabled, ShoreGear switches build an internal routing database from the peer-to-peer communication with other switches. Each ShoreGear switch contains routing information for all endpoints in the system, including information regarding trunk selection for outbound calls. When a user places a call from any extension, each switch can route the call to the correct ShoreGear switch based on its internal routing database.

When the Distributed Routing Service is enabled, ShoreGear switches only exchange routing information with other switches at the same site, rather than exchanging the information with every switch in a multi-site system. Although each ShoreGear switch only maintains routing information within its site, each ShoreWare server also includes an instance of the Distributed Routing Service, which maintains system-wide routing information. When calls are initiated, ShoreGear switches contact the Distributed Routing Service in order to find the ShoreGear switch or switches necessary to complete the call.

In a system with more than one ShoreWare server, the ShoreGear switches may contact an alternate instance of the routing service if the primary instance is not reachable. ShoreWare servers have a hierarchical relationship with the headquarters server at the top of the hierarchy. As you add servers to the system through ShoreWare Director, you define the order of the servers in relation to the headquarters server and the various sites in your system. Initially, the switches try to contact the nearest instance of the Distributed Routing Service in the hierarchy. If that instance of DRS is not reachable, the switch contacts the instance of DRS at the parent server in the hierarchy as a fallback. If both instances of DRS are not reachable, the switch makes a best effort to route the call based on its internal routing tables built from communicating with peer ShoreGear switches at the same site.

Distributed Applications Platform

The distributed applications platform of the ShoreTel 7.5 system enables application servers to be distributed across the enterprise yet still behave as a single, cohesive system. This allows you to optimize network performance by locating applications such as voice mail close to users to reduce WAN bandwidth utilization. In addition, by hosting applications, services, and APIs on multiple platforms, the distributed applications platform enables the system to scale as necessary.

A software component called the ShoreWare Telephony Management Service (TMS) runs on the ShoreWare servers and observes all call setup and call teardown activity on the entire voice network. The ShoreWare TMS software then exposes a Telephony Application Programming Interface (TAPI), for call control, and a TAPI Wave interface for media play and record. These open APIs allow value-added applications to be added to the ShoreTel 7.5 system to provide voice services.

Even though there are multiple application servers, the ShoreTel 7.5 system is still managed and behaves as a single image system with complete feature transparency between sites.

Single System Management

The ShoreTel 7.5 system provides a single system management solution called ShoreWare Director. This browser-based network management tool provides a single management interface for all voice services and applications across all locations. Even though there are multiple servers and switches to support the services and applications, the ShoreTel 7.5 system provides a single image system across your entire network.

Integrated management enables a change to propagate dynamically across the system each time a modification is made on the ShoreTel 7.5 system. When you add a new user on the ShoreTel 7.5 system, the user automatically gets a dialing plan, voice mail, an extension, a mailbox, an Auto-Attendant profile, and an e-mail message to download the desktop software. In addition, the user can be added to an Automated Call Distributor (ACD) group, if needed. You add new users and place them in ACD groups from a single management screen.

The ShoreTel 7.5 system provides automated software distribution for all components on the system. When you add a new ShoreGear voice switch to the system, it is automatically upgraded to the current software release by the ShoreWare server. When you add a new user on the system, the user receives an e-mail message containing a URL from which desktop call control and unified messaging applications can be download and installed.

For software upgrades, you simply install the new software on the ShoreWare server, and all the ShoreGear voice switches, across all locations, are automatically upgraded to the new release. In addition, users are notified of the new software release and are automatically prompted to upgrade their software, if an upgrade is mandatory.

The ShoreTel 7.5 management software also provides a complete suite of maintenance tools that enable you to monitor and change the status of components on the system. The system can be configured with event filters that automatically generate an e-mail message if an error occurs on the system.

Multi-level Management

The ShoreTel 7.5 system provides in-depth access levels to ShoreWare Director. System parameters for administrative permissions allow many administrative roles to be defined so as to provide only as much access to the system as each user requires. By default, the initial system administrator has access to everything on the system. However, by using the administrative permissions pages, you can define site administrators, directory list managers, read-only users, and more. Each user who needs to access ShoreWare Director can be assigned a level of permission tailored for his needs.

System Reliability

The ShoreTel 7.5 system provides a number of features and options that ensure system reliability, including:

- Distributed Switch Control
- Embedded IP Phone Display
- IP Phone Keep Alive
- IP Phone Failover
- Public Switched Telephone Network (PSTN) Failover

- Distributed CDR

Distributed Switch Control

The ShoreWare Telephony Management Service (TMS) runs on every ShoreWare distributed server, ensuring switch control even if there a WAN outage between the remote server and the headquarters site. Since multiple servers share the task of switch management, if a server fails, only the extensions it controls may be affected by a disruption in service.

Embedded IP Phone Display

The Embedded IP Phone Display feature essentially shifts support of several tasks related to IP phone operation from the server to the switch. This enhances system reliability and offers better uptime. The following features are supported on the switch and thus will continue to be available even when the server is down:

- Phone display
- Transferring a call
- Conference calls
- Placing calls on hold
- On-hook dialing
- Intercom
- Redial
- Pickup
- Park
- Unpark

The following features that require writing to the database will continue to be supported by the server and not the switch:

- Directory
- Options
- Speed dial (due to its reliance on the database)
- Ability to change call handling modes
- Workgroup Agent Wrap up
- Monitoring extensions on other switches
- Presence information for user serviced by other switches

IP Phone Keep Alive

The ShoreGear-120/24, ShoreGear-90, ShoreGear-60/12, ShoreGear-50, ShoreGear-40/8, and ShoreGear-220T1/E1 voice switches send a heartbeat to their associated IP phones once a minute. If the heartbeat is not acknowledged within approximately four seconds, the switch considers the IP phone to be offline or unavailable. The switch continues to broadcast the heartbeat every minute. Any currently offline IP phone that returns an acknowledgement is considered online and available.

IP Phone Failover

IP phones can be optionally configured to send a heartbeat to their ShoreGear switch every four minutes. If an IP phone cannot communicate with its switch, the phone

automatically connects to another switch located at the same site. For IP phone failover to be effective, the system must be planned with sufficient excess capacity to handle phones from at least one switch during a failover event. For example, if a switch with 20 IP phone ports fails, 20 IP phone ports need to be available elsewhere at the same site.

The feature allows an administrator to configure the system so there can be failover of phones from one switch to another in the case of a switch failure. The feature is not intended to provide failover for network outages (i.e. or lost connectivity between the headquarters server and a remote site)¹. Some network outage scenarios may be handled by the ShoreTel failover solution.

Failover will occur on a phone by phone basis and will be driven by receiving RSIP from the phone. IPCS will not move phones other than the one sending RSIP. Each phone must initiate its own failover.

For configuration details, see the *ShoreTel 7.5 Administration Guide*.

Public Switched Telephone Network (PSTN) Failover

User extensions can be optionally configured to route extension-to-extension calls to the public switched telephone network (PSTN) in the event that an IP connection is unavailable. Extension-to-extension calls are those a user makes to another site within a multi-site system, for example, a user in New York calling a co-worker at the company's San Francisco office. The IP connection may be unavailable due to lack of bandwidth or connectivity.

The PSTN failover option must be explicitly enabled for each user and bypasses the caller's call permissions. For configuration details, see the *ShoreTel 7.5 Administration Guide*.

NOTE For systems using the Distributed Routing Service (DRS), PSTN failover for outbound calls will not function when the local switches lose connectivity to a DRS server. When a site does not have connectivity to DRS, users at other sites with DRS connectivity will be able to reach the users at that site using PSTN failover (as long as the destination site has trunks to accept the PSTN calls). This limitation has the biggest impact for small offices that do not have a local ShoreWare server.

Distributed CDR

In the event of a WAN outage, Call Detail Record (CDR) data is stored for up to two hours on the distributed server. When WAN connectivity is restored, the stored data is forwarded to the Headquarters Server's database. After two hours, the distributed server deletes the data and logs an error to the local server's NT event log.

1. You should verify that you have sufficient hardware to meet the failover needs of your particular environment.

Integrated Applications

The ShoreTel 7.5 system includes a suite of applications that are integrated with the system. These applications (which are discussed in the following sections) include:

- Account Codes
- Voice Mail
- Automated Attendant
- Hunt Groups
- Workgroups
- Pickup Groups
- Queue Monitor
- Agent Monitor
- Directory Viewer
- History Viewer
- Call Detail Recording
- Desktop Call Control Service
- Unified Messaging Service

NOTE TAPI-compliant, third-party applications can also be added on a distributed server. Such servers should have no voice mail users.

Account Codes

An Account Codes Collection Service (ACC) allows assignment of account codes or activity codes to outbound calls. The system supports account codes that can vary in length and format. Account code collection is enabled on a per-user group basis with the collection of account codes set to one of three states: disabled, optional, or forced. Call Detail Reports include details of the account codes associated with outbound calling. The Account Codes Service is associated with a configurable extension and has a dedicated user group that defines ultimate call permissions and trunk group access. In addition, wildcard characters can be used in place of any DTMF digit in the account code. The use of wildcards introduces less strict validation of the account code entered by the user. Rather than checking each individual code, with the introduction of wildcards, a length check is performed. The wildcard allows the system to support far more than the previous limit of 50,000 codes.

Voice Mail

The integrated voice mail application provides automated call answering, voice mail recording, and message playback. Since voice mail is simply a software application, there are no “port” or “storage” limitations as in traditional voice mail systems. To reduce WAN bandwidth utilization, the voice mail application can be distributed across the IP network.

Each mailbox supports five call handling modes (including Standard, In a Meeting, Out of the Office, Extended Absence, and Custom), each with its own greeting. Each mailbox also provides message notification to an extension, external number (cell phone), or pager.

Find Me forwarding and Auto Find Me¹ forwarding allow calls to be forwarded from the voice mail greeting to up to two numbers. If the call is not accepted at either of the Find Me destinations, the call is returned to voice mail.

The Auto-delete by Number of Days feature allows a system administrator to set a maximum time limit, (ranging from a month to several years) for the storage of voice mail messages. The tool can be used to encourage users to better manage their voice mailboxes. When the feature is enabled and a user has old messages that are approaching the expiration time limit, the user will receive warning messages indicating that those voice mail messages will be deleted.

The Mailbox Full Notifications feature lets users know when their mailbox has approached the maximum capacity. The system sends users a notice informing them that their mailbox is almost full and that there is only enough room for 10 additional messages. Each time users log into voice mail, they will receive the notification telling them how much space remains. In this way, mailbox owners are given adequate notice that they must clean up their mailboxes and they are not caught off-guard by an unexpected (and unwanted) “mailbox full” notification.

Escalation Notification is a traditional voice mail feature that allows support groups to offer round-the-clock service to their customers. Thus, if a customer calls into the ShoreTel voice mail system to leave a message requesting urgent service, the system will send out a page, phone call, or email to an employee in the support department. If this first employee were to ignore the notification for a specified period of time, another employee in the escalation profile would be contacted until someone listens to the customer's voice mail and handles the problem.

For details on configuring any of these voice mail features, please refer to the *ShoreTel 7.5 Administration Guide*.

For specific information about the supported capacity for voice mail on the ShoreTel 7.5 system, see the table “ShoreTel 7.5 System Capacity” on page 2-25.

Automated Attendant

The integrated automated attendant application provides automated call answering and call redirection, including dialing by name and dialing by number. As with voice mail, there are no “port” limitations such as exist in traditional systems. The automated attendant application is distributed across all the application servers when multiple servers are provisioned. All menus are available locally at every server. Calls directed to the automated attendant at a site with a server are handled by the local server.

Each automated attendant (AA) menu supports up to four different modes (On-Hours, Off-Hours, Holiday, and Custom) that can be automatically driven by schedules. In addition, users can record AA menu prompts from their own telephone, instead of having to go through ShoreWare Director. This ability frees the system administrator from having to be involved with the task of recording AA menus, allowing him or her to delegate the task to more appropriate team members.

Users can record a different AA menu prompt for each call-handling mode (On-Hours, Off-Hours, Holiday, and Custom). This feature can be enabled or disabled on a per-menu basis.

Each AA menu will have its own password and a unique, dialable number. A separate “Menu Mailbox” is created for each AA menu, allowing users to dial into the system to

1. ShoreTel users can automate the Find Me behavior such that when a call enters voice mail, the call is immediately sent to the Find Me destination numbers without requiring the caller to enter any digits. Earlier ShoreTel releases required the caller to “press 1 to find this user.”

change the menu prompts in the same way that they would change their personal mailbox greeting.

For specific information about the supported capacity for automated attendants on the ShoreTel 7.5 system, see the table “ShoreTel 7.5 System Capacity” on page 2-25.

Hunt Groups

Hunt groups allow you to route calls to a list of extensions. Hunt groups can be accessed via an extension, DID, and/or DNIS mappings. Hunt groups are supported by ShoreGear switches and remain available when connectivity to the Headquarters server is lost. The hunt group can be used as the backup destination for a workgroup, so that some basic hunting can be done even when the workgroup server is not reachable. To maximize reliability, assign hunt groups to a switch close to the majority of the members and/or trunks associated with the hunt group.

A maximum of 8 hunt groups can be assigned to a single switch. A total of 16 user numbers can be assigned to hunt groups on a single switch.

For more information on hunt groups, see “Hunt Groups” on page 11-20.

Workgroups

The ShoreTel 7.5 system provides the contact center with flexibility for distributing callers to available agents, as well as options for managing calls when agents are not available. Inbound calls are directed to a workgroup application on the headquarters server that distributes calls to agents in one of four administrator-configured patterns (Top Down, Round Robin, Longest Idle, or Simultaneous Ring). When no agents are available, calls can be directed to a queue where they are held until an agent becomes available.

Workgroup overflow and interflow capabilities can be configured to reduce the wait time for callers who are dialing into an ACD, thus ensuring faster service and greater customer satisfaction. (“Overflow” refers to transferring a call from one workgroup queue to another once a wait-time threshold has been exceeded, and “interflow” refers to transferring a call to another dialable number (e.g. an extension, menu, or an external number) once a wait-time threshold has been exceeded.¹

Alternatively, if calls are unanswered, they can be directed to a workgroup mailbox accessible by all agents. Agents may belong to multiple workgroups, and an agent’s login status applies to all the workgroups of which that agent is a member.

Distribution of the inbound calls is managed based on agent status. When agents are ready for calls, they log in and begin to receive calls. When they complete their day, they log out, and calls are no longer delivered. In addition, the workgroup can optionally be configured so that all agents enter a “wrap-up” mode after every call. In this mode, agents remain logged in but do not receive new calls until the configured wrap-up time passes. This enables agents to complete any required updates to the customer records between calls.

When an agent is a member of multiple workgroups, and calls are available from different workgroups, the agent receives the longest waiting caller regardless of workgroup.

1. For more information about configuring overflow and interflow, please see the “Configuring Workgroups” chapter in the *ShoreTel 7.5 Administration Guide*.

Each workgroup and each queue supports four different modes (On-Hours, Off-Hours, Holiday, and Custom) that can be automatically driven by schedules.

For specific information about the supported capacity for workgroups on the ShoreTel 7.5 system, see the table “ShoreTel 7.5 System Capacity” on page 2-25.

Pickup Groups

Pickup Groups are a traditional PBX and key system feature used in group environments to allow users in a pickup group to answer any ringing phone in that group. The feature works best in places where a several people work together on a daily basis, such as design firms. If a group member is away from her desk and across the room while her phone rings, she can quickly answer the call from another IP phone by pressing the relevant soft key or programmable button, or by using a simple (feature code) star command from an analog phone.

Pickup groups can include the following types of extensions:

- User extensions
- Workgroup extensions
- Bridged Call Appearance (BCA) extensions
- Office Anywhere extensions

For more information on configuring Pickup Groups, please refer to the *ShoreTel 7.5 Administration Guide*.

Queue Monitor

The ShoreWare Queue Monitor is embedded in the Agent and Supervisor Call Manager client software. The Queue Monitor allows agents and supervisors to monitor business-critical queue statistics and information in real time.

For agents belonging to multiple workgroups, the Queue Monitor displays queue information for all workgroups of which the agent is a member.

Agent Monitor

The ShoreWare Agent Monitor provides workgroup supervisors with a real-time view on call center activity. The Agent Monitor shows status information for agents in all the workgroups of which the supervisor is a member, including the agent's login state (logged in, logged out, in wrap-up mode), current call activity, and current call duration.

Directory Viewer

Directory Viewer is a convenient phone book of system and personal contacts for anyone who does not use Microsoft Outlook. Users can view contacts, change contact information, and initiate calls from the viewer.

History Viewer

Available through Call Manager, the History Viewer displays a detailed log of both incoming and outgoing calls. Users can search the history for phone numbers of past callers. For each call, the History Viewer displays the source or destination number, the start time, and duration.

Call Detail Record (CDR)

The ShoreTel 7.5 system tracks all call activity on the system, across all locations, and generates call detail records into a single database on the main ShoreWare server. The

system comes bundled with the reports that use information from the database, including User Activity, Trunk Activity, Workgroup Agent Activity, Workgroup Queue Activity, Workgroup Service Level Summary, Account Code Activity, and WAN Activity.

Web-based CDR reports offer the primary method of accessing and viewing CDR data in the MySQL database. Reports can be run from ShoreWare Director, and after the reports have been generated, they can be printed, exported, and navigated interactively. In addition, by purchasing the proper keyed license, users can run a web-based CDR report remotely from clients other than the headquarters machine.

The system also stores call information in a text file that can be used by third-party call accounting packages. And for the benefit of legacy call accounting systems that cannot read from a database or from a text file, the ShoreTel system supports the ability to send CDR data out a serial port on the main ShoreWare server. If the serial port should become unavailable, the CDR data will be queued in a buffer for 300 seconds to help prevent the loss of data.

To make it easier for the ShoreTel system to integrate with various third-party SNMP monitoring tools, the ShoreTel system formats CDR media stream statistics and stores the data in a log file on the system. This helps users acquire a more accurate picture of the traffic patterns in their network, and the information can be useful in performing load analysis, identifying peak traffic times, and assisting the customer in setting up competitive pricing strategies.

Desktop Call Control Service

The Desktop Call Control service application provides call status and call control to every user on the system. This is provided through a Remote TAPI Service Provider (RTSP) that is on every desktop using ShoreTel's Call Manager applications and other desktop TAPI applications.

Unified Messaging Service

Unified Messaging, ShoreTel's Outlook integration feature, provides an interface to the messaging applications on the desktop computers. This feature provides access to voice mail from Microsoft Outlook for each user, enabling users to manage their voice mail messages in the same way that they currently manage their e-mail messages.

In addition, Unified Messaging enables access to the system directory and each user's personal options. Unified Messaging also allows users to take advantage of the calendar-based call handling feature, which lets employees customize how calls are routed when they are not available.

Optional Applications

To augment the ShoreTel 7.5 solution, ShoreTel offers conference bridge and contact center applications as system options.

ShoreTel Converged Conference Solution

The ShoreTel Converged Conference Solution provides easy-to-use, cost-effective audio-and-data conferencing. During a conference call, users can share PowerPoint, MSWord, Excel, or text documents with other conference participants.

The ShoreTel Converged Conference Solution includes the ShoreTel Conference Bridge, ShoreTel Conference Manager, and ShoreTel Conference Director. The ShoreTel Conference Bridge is a 1U rack-mounted conference server connected to your ShoreTel 7.5 system via an Ethernet connection to your IP network. The ShoreTel Conference Manager is an intuitive, browser-based interface for conference call scheduling and call control. ShoreTel Conference Director is a browser-based management interface for the administration and maintenance of the ShoreTel Conference Bridge.

ShoreTel Conference Bridge

The ShoreTel Conference Bridge is an embedded, preconfigured conference appliance that interfaces to your ShoreTel 7.5 system via your IP network. The conference bridge supports 12, 24, 32, 48, or 96 ports.

ShoreTel Conference Manager

The ShoreTel Conference Manager enables conference call users to:

- Establish reservationless conferences
- Set up scheduled and recurring conference calls
- Start a conference call “on the fly”

For more information on ShoreTel Conference Manager, see the *ShoreTel Conference Manager User Guide*.

ShoreTel Conference Director

ShoreTel Conference Director provides an intuitive interface for operations, administration, maintenance, server configuration, service/user provisioning, and monitoring/alarm control.

Required authorization and authentication ensures that only valid users use the conference bridge services. To meet the highest security requirements, the server utilizes SSL encryption for secured messages and server side digital certificates.

ShoreTel Contact Center Solution

ShoreTel Contact Center Solution is a comprehensive routing and management system designed to control and monitor the activities of your contact center. The ShoreTel Contact Center Solution includes the ShoreTel Contact Center Server Software or ShoreTel Enterprise Contact Center Server Software, ShoreWare Contact Center Director, ShoreWare Agent Manager Software, and ShoreWare Agent Toolbar Software.

The ShoreTel Contact Center Server Software, together with its Interactive Voice Response package (IVR), provides the contact center administrator with sophisticated call routing options. These options include routing incoming calls by customer ID (or ANI), routing incoming calls by DNIS (the number dialed), routing incoming calls according to the agent that best fits the skill required (skills-based routing), statistical routing to route the incoming call by TSF (Target Service Factor), and more. In addition, the ShoreTel Contact Center Server Software uses scripts to collect information from the organization's database and the callers, using many IVR actions, and routes the call according to that information.

Incoming calls are routed to agents according to:

- The service required by the DNIS (number dialed)
- The customer, if the customer is identified in the organization's database

- A call control script that directs the call according to information extracted from the caller
- Best skill fit of the agent
- The longest waiting time

The ShoreWare Contact Center Director module enables authorized supervisors to define the parameters of different system entities (for example, agents, agent groups, trunk groups) and easily modify their profiles. There are several administration levels with different access rights.

The ShoreWare Agent Manager monitors contact center activities and provides real-time information, as well as generates reports summarizing the system performance over a given time period. The ShoreWare Agent Manager also provides statistical analysis of the contact center system behavior within a specified period.

The ShoreWare Agent Toolbar provides the agent with all the necessary information regarding the type of an incoming call and caller, before the agent answers the call. Agents can perform all telephony functions from their desktops with this Windows-based application.

ShoreWare System Monitor

ShoreWare System Monitor is a Windows 2003/XP service that uses SNMP to monitor statistics and utilization for each interface on each switch. If data-link errors or utilization rates rise above a settable threshold, the generated web pages help determine the source of the network problems.

ShoreWare System Monitor discloses network weaknesses that cause data and VoIP stability issues, and by monitoring all network interfaces for utilization, packet loss, and errors, it becomes easy to determine exactly where network faults exist.

ShoreWare System Monitor provides information about the specific error or issue that is causing degradation to assist in troubleshooting and resolution, and it maintains a history of utilization and errors on all interfaces to assist in troubleshooting VoIP and network problems after they occur.

All network devices that support SNMP can be queried for link status and health information

Desktop Applications

The ShoreTel 7.5 system provides a suite of integrated desktop productivity applications targeted at the needs of different users. The ShoreTel Call Manager applications offer varying levels of functionality suited to different role requirements.

- Personal Call Manager
- Advanced Call Manager
- Workgroup Agent Call Manager
- Workgroup Supervisor Call Manager
- Operator Call Manager
- SoftPhone
- Web Access
- Office Anywhere™

Personal Call Manager

The Personal Call Manager (PCM) level provides desktop call control as well as voice mail, directory, and call logging features. Microsoft Outlook users can integrate their voice mail, contacts, and calendar with the ShoreTel 7.5 system. This level is available to all users and delivers desktop call control, visual voice mail, call history, and directory services, as well as options to control call handling and message notification. The Call Manager software supports Programmable Toolbars, allowing a system administrator to assign common operations to a button on a user's call manager toolbar so that they can perform many basic telephony operations just by clicking a button in PCM.

NOTE The term "PCM" is used throughout this document to refer collectively to all of the different levels of Call Manager software listed in the bulleted list above.

Advanced Call Manager

In addition to supporting all of the basic features provided by PCM, the Advanced Call Manager level provides "presence" information about other users on the system and is targeted at professionals who use the telephone heavily, typically users who need detailed information about the users they call. The QuickDialer shows if the destination is busy and indicates the call handling status of the destination (standard or nonstandard).

Workgroup Agent Call Manager

In addition to supporting all of the basic features provided by PCM, the Workgroup Agent level is typically assigned to the members of a workgroup and provides access to workgroup features, including login, logout, and wrap-up, as well as access to the Queue Monitor and shared workgroup mailbox.

Workgroup Supervisor Call Manager

In addition to supporting all of the basic features provided by PCM, the Workgroup Supervisor level of call management, typically assigned to a workgroup supervisor, provides access to the Agent Monitor.

Operator Call Manager

In addition to supporting all of the basic features provided by PCM, the Operator Call Manager level, typically assigned to operators, secretaries, and executive assistants, provides detailed information about destination extensions, including access to the Extension Monitor. It offers control features that enable a business to cost-effectively provide a "high touch" level of personalized attention to its callers. ShoreWare Operator Extension Monitor lets operators monitor and manage calls for any group of selected extensions.

SoftPhone

A SoftPhone is available to licensed users, allowing users to place and receive calls from their PC.

Web Access

Users can have remote access to their call handling options via a browser-based interface.

Office Anywhere™

Office Anywhere allows users to maintain an on-system extension presence at an external PSTN number. A mapping is created between a user's office phone extension and his cell phone or PSTN phone number (at his home office), making it appear as though his PSTN phone is part of the ShoreTel system. The feature allows the user to manage the call via PCM, so while the conversation occurs over the cell phone or home phone, the call appears via PCM and can be acted upon using many of the features available via PCM.

Voice Switches

The ShoreGear voice switches provide the physical connectivity to voice endpoints and provide a highly reliable, highly scalable platform for the ShoreWare distributed call control software. The call control software runs on top of VxWorks, a real-time embedded operating system designed specifically for mission-critical applications. The voice switches have FLASH memory that allows permanent storage of the call control software and configuration information. Except for a highly reliable fan, the voice switches have no moving parts (for example, no hard drive). Internal sensors automatically monitor the fan as well as the temperature, and if any failure occurs the system can automatically notify the system administrator, through e-mail if desired. The voice switches include the necessary Digital Signal Processor (DSP) technology to enable toll-quality voice, with features such as echo cancellation, voice compression, and silence suppression.

Each ShoreGear voice switch connects to the IP network using a 10/100M Ethernet interface. If more sites or ports are required, you simply connect additional ShoreGear voice switches to your IP network. The system is inherently scalable, unlike legacy PBX systems that have hardware growth limitations with line cards, shelves, cabinets, and systems.

ShoreGear voice switches reboot in less than 60 seconds, providing fast fault recovery.

ShoreGear voice switches feature a backup operator in case the site operator is unreachable due to network outages. To use this feature, configure port 9 on ShoreGear-120/24 and ShoreGear-60/12, port 5 on ShoreGear-40/8 as an operator extension and connect an analog phone to the port.

ShoreGear-120/24

The ShoreGear-120/24 supports 24 analog ports (8 universal telephone/trunk ports and 16 telephone ports), or up to 120 IP phones. The ShoreGear-120/24 interfaces to standard analog trunks using loop-start or wink-start signaling, as well as to standard analog telephones, including CLASS feature phones with Caller ID Name and Number, and Message Waiting Indicator. This switch also supports basic media encryption at the application layer.

ShoreGear 90

The SG-90 voice switch simultaneously supports 30 IP phones and 12 analog ports. The switch is designed to be slimmer than prior ShoreGear switch models and is 1U (half-rack width). The ShoreGear 90 interfaces to standard analog trunks using loop-start or wink-start signaling, as well as to standard analog telephones, including CLASS feature phones with Caller ID Name and Number, and Message Waiting Indicator. This switch also supports basic media encryption at the application layer.

ShoreGear 90BRI

The SG-90BRI voice switch simultaneously supports 30 IP phones, 4 BRI ports and 4 analog extension ports. The switch is designed to be slimmer than prior ShoreGear switch models and is 1U (half-rack width). The SG-90BRI has 4 BRI spans, each with 2 channels and independent signaling parameters. Each span can be enabled or disabled individually. The ShoreGear 90BRI interfaces to standard analog trunks using loop-start or wink-start signaling, as well as to standard analog telephones, including CLASS feature phones with Caller ID Name and Number, and Message Waiting Indicator. This switch also supports basic media encryption at the application layer.

ShoreGear-60/12

The ShoreGear-60/12 provides 12 analog ports (8 universal telephone/trunk ports, 4 telephone ports) and up to 60 IP phones. The ShoreGear-60/12 interfaces to standard analog trunks using loop-start or wink-start signaling, as well as to standard analog telephones, including CLASS feature phones with Caller ID Name and Number, and Message Waiting Indicator. This switch also supports basic media encryption at the application layer.

ShoreGear 50

The SG-50 voice switch simultaneously supports up to 20 IP phones and offers 6 analog ports. The switch is designed to be slimmer than prior ShoreGear switch models and is 1U (half-rack width). The ShoreGear 50 interfaces to standard analog trunks using loop-start or wink-start signaling, as well as to standard analog telephones, including CLASS feature phones with Caller ID Name and Number, and Message Waiting Indicator. This switch also supports basic media encryption at the application layer.

ShoreGear-40/8

The ShoreGear-40/8 provides 8 analog ports (2 universal telephone/trunk ports, 2 loop-start trunk-only ports, and 4 telephone ports), or up to 40 IP phones. The ShoreGear-40/8 interfaces to standard analog trunks using loop-start or wink-start signaling, as well as to standard analog telephones, including CLASS feature phones with Caller ID Name and Number, and Message Waiting Indicator. This switch also supports basic media encryption at the application layer.

ShoreGear-T1

The ShoreGear-T1 provides high-density digital voice trunking to the central office using T1, PRI, or QSIG signaling. It can also be used as a gateway to legacy PBX systems. This switch also supports basic media encryption at the application layer.

The QSIG protocol handles the signaling between digital private branch exchanges (PBXs) for Integrated Services Digital Networks (ISDN), and is based on the Q.931 standard. By designating network elements as master or slave, QSIG handles the basic signaling functions of call setup, handshaking, and call teardown, and allows PBXs from different third-party vendors to communicate and interoperate. QSIG is based on ECMA standard (see ECMA-142 and ECMA-143 for more information), and supports calling party number, and calling party name. Inbound calling party name is fully supported, but outbound calling party name is only supported for Off-System Extension calls.

ShoreGear-E1

The ShoreGear-E1 provides high-density digital voice trunking to the central office using PRI or QSIG signaling for international installations. It can also be used as a gateway to legacy PBX systems. This switch also supports basic media encryption at the application layer.

The QSIG protocol handles the signaling between digital private branch exchanges (PBXs) for Integrated Services Digital Networks (ISDN), and is based on the Q.931 standard. By designating network elements as master or slave, QSIG handles the basic signaling functions of call setup, handshaking, and call teardown, and allows PBXs from different third-party vendors to communicate and interoperate. QSIG is based on ECMA standard (see ECMA-142 and ECMA-143 for more information), and supports calling party number, and calling party name. Inbound calling party name is fully supported, but outbound calling party name is only supported for Off-System Extension calls.

ShoreGear 220T1

The SG-220T1 voice switch simultaneously supports 100 IP phones and a single T-1 interface that can either do PRI or CAS signaling. The switch is designed to be slimmer than prior ShoreGear switch models and is 1U (half-rack width). This switch also supports basic media encryption at the application layer.

ShoreGear 220T1A

The SG-220T1A voice switch simultaneously supports 70 IP phones, four analog extension ports, two analog extension trunks and a single T-1 interface (PRI or CAS signaling). The switch is designed to be slimmer than prior ShoreGear switch models and is 1U (half-rack width). This switch also supports basic media encryption at the application layer.

ShoreGear-220E1

The ShoreGear-220E1 The SG-220E1 voice switch simultaneously supports 70 IP phones and a single E1 interface that can do PRI signaling. The switch is designed to be slimmer than prior ShoreGear switch models and is 1U (half-rack width). This switch also supports basic media encryption at the application layer.

ShoreTel IP Phones and Devices

Both analog and IP telephones are available from ShoreTel. With ShoreTel IP phones, you create an end-to-end IP network, or a single-wire-to-the-desktop solution. The ShoreTel IP phone's intuitive user interface gives the user a high comfort level when performing phone operations.

For specific information about the supported capacity for IP and analog telephones on the ShoreTel 7.5 system, see the table "ShoreTel 7.5 System Capacity" on page 2-25.

ShorePhone-AP100

The ShorePhone-AP100 telephone provides a cost-effective analog solution for business desktops, and is supported by the ShoreGear-120/24, ShoreGear 90, ShoreGear 90BRI, ShoreGear-60/12, ShoreGear 50, ShoreGear-40/8, ShoreGear 220T1/E1/T1A voice switches.

Key features include:

- Large display for caller name, number, and directory access
- High-quality speaker telephone
- Menu access to common features

ShorePhone-IP100

The ShorePhone-IP100 telephone is supported by the ShoreGear-120/24, ShoreGear 90, ShoreGear 90BRI, ShoreGear-60/12, ShoreGear 50, ShoreGear-40/8, ShoreGear 220T1/E1/T1A voice switches.

Key features include:

- Coordination with desktop information for speed dialing and caller name display
- One-key access to features such as voice mail, transferring, conferencing, and redialing
- Extension monitoring for up to four extensions
- Integrated hands-free intercom
- InstaDial™ functionality in which calls are automatically transferred after digit collection stops and a configurable timeout period has expired
- Limited support for programmable buttons and extension monitoring

ShorePhone-IP110

The ShorePhone-IP110 phone is a cost-effective phone designed for general use. The ShorePhone-IP110 telephone is supported by the ShoreGear-120/24, ShoreGear 90, ShoreGear 90BRI, ShoreGear-60/12, ShoreGear 50, ShoreGear-40/8, ShoreGear 220T1/E1/T1A voice switches.

Key features include:

- Single-line display for caller information
- Six function keys (Conference, Hold, Inter-com, Redial, Transfer, Voice Mail)
- Ethernet Switch port for connecting a PC to the back of the phone
- Support for basic media encryption for calls inside a ShoreTel network
- Ability to load custom ring tones in .wav file format

ShorePhone-IP115

The ShorePhone-IP115 phone is a cost-effective phone that is based on the IP110 model, but with the addition of an external microphone to support speakerphone functionality.

The ShorePhone-IP115 telephone is supported by the ShoreGear-120/24, ShoreGear 90, ShoreGear 90BRI, ShoreGear-60/12, ShoreGear 50, ShoreGear-40/8, ShoreGear 220T1/E1/T1A voice switches.

Key features include:

- External microphone to support speakerphone
- Single-line display for caller information
- Six function keys (Conference, Hold, Intercom, Redial, Transfer, Voice Mail)
- Ethernet Switch port for connecting a PC to the back of the phone
- Support for basic media encryption for calls inside a ShoreTel network
- Ability to load custom ring tones in .wav file format

ShorePhone-IP210

The ShorePhone-IP210 phone is a cost-effective phone designed for general use.

The ShorePhone-IP210 telephone is supported by the ShoreGear-120/24, ShoreGear 90, ShoreGear 90BRI, ShoreGear-60/12, ShoreGear 50, ShoreGear-40/8, ShoreGear 220T1/E1/T1A voice switches.

Key features include:

- Single-line display for call information
- Four function keys (Conference, Hold, Intercom, Redial, Transfer, Voice Mail).
- Ethernet Switch port for connecting a PC to the back of the phone
- Support for basic media encryption for calls inside a ShoreTel network
- Ability to load custom ring tones in .wav file format

ShorePhone-IP212k

The 212k IP phone is designed to function as a key phone and offers 12 custom buttons that can be used for line appearance and other functions. The 212k is ideal for small offices and branch offices that require key system functionality.

The ShorePhone-IP212k telephone is supported by the ShoreGear-120/24, ShoreGear 90, ShoreGear 90BRI, ShoreGear-60/12, ShoreGear 50, ShoreGear-40/8, ShoreGear 220T1/E1/T1A voice switches.

Key features include:

- Scrolling text that allows for the display of more information.
- Menu and Select buttons that provide services similar to soft keys and scroll bar, and that assist in phone navigation and programming
- Eight function keys (Voice Mail, Transfer, Options, Conference, Directory, Intercom, Redial, Hold)
- InstaDial™ functionality in which calls are automatically transferred after digit collection stops and a configurable timeout period has expired
- Automatic Off-Hook Preference that lets users select which audio path. (speakerphone or headset) is auto-activated when calls are sent or received

- Ethernet Switch port for connecting a PC to the back of the phone
- A first (upper left-most) custom button that is reserved for line appearance only and cannot be configured to perform other functions
- Support for basic media encryption for calls inside a ShoreTel network.
- Ability to load custom ring tones in .wav file format
- Built-in handset lifting functionality to support certain Plantronics wireless headset models

ShorePhone-IP230

The ShoreTel IP230 Phone is a full-featured yet inexpensive IP phone that is similar to the ShoreTel IP210 phone, but with the added functionality of programmable buttons.

The ShorePhone-IP230 telephone is supported by the ShoreGear-120/24, ShoreGear 90, ShoreGear 90BRI, ShoreGear-60/12, ShoreGear 50, ShoreGear-40/8, ShoreGear 220T1/E1/T1A voice switches.

Key features include:

- The IP230 has 3 custom buttons that can be programmed for extension monitoring, speed dial, and other functions. Note that the top-most button is reserved for line appearance. (Each “button” is an LED-enabled hard key and has an associated 6 character label on the LCD.)
- Eight function keys (Voice Mail, Transfer, Options, Conference, Directory, Intercom, Redial, Hold)
- InstaDial™ functionality in which calls are automatically transferred after digit collection stops and a configurable timeout period has expired
- Monochrome black and white display
- Automatic Off-Hook Preference that lets users select which audio path (speakerphone or headset) is auto-activated when calls are sent or received
- Ethernet Switch port for connecting a PC to the back of the phone
- Support for basic media encryption for calls inside a ShoreTel network
- Support for two-line caller ID display feature, which displays the caller name and number on two separate lines for in-coming calls and outbound calls
- Ability to load custom ring tones in .wav file format
- Built-in handset lifting functionality to support certain Plantronics wireless headset models

ShorePhone-IP530

The ShorePhone-IP530 is designed for professional users. The ShorePhone-IP530 telephone is supported by the ShoreGear-120/24, ShoreGear 90, ShoreGear 90BRI, ShoreGear-60/12, ShoreGear 50, ShoreGear-40/8, ShoreGear 220T1/E1/T1A voice switches.

Key features include:

- Three-line display for call information
- Backlit display
- Caller ID display for up to three calls simultaneously
- Monitoring for up to two extensions
- Eight function keys
- Four soft keys

- Ethernet Switch port for connecting a PC to the back of the phone
- InstaDial™ functionality in which calls are automatically transferred after digit collection stops and a configurable timeout period has expired
- Automatic Off-Hook Preference that lets users select which audio path (speakerphone or headset) is auto-activated when calls are sent or received
- Support for basic media encryption for calls inside a ShoreTel network
- Support for programmable buttons and extension monitoring
- Support for two-line caller ID display feature, which displays the caller name and number on two separate lines for in-coming calls and outbound calls
- Ability to load custom ring tones in .wav file format

ShorePhone-IP560

The ShorePhone-IP560 is a high-end phone designed for executives, assistants, and operators who handle high call volumes and share call flows with other users. The ShorePhone-IP560 telephone is supported by the ShoreGear-120/24, ShoreGear 90, ShoreGear 90BRI, ShoreGear-60/12, ShoreGear 50, ShoreGear-40/8, ShoreGear 220T1/E1/T1A voice switches.

Key features include:

- Caller ID display for up to six calls simultaneously
- Backlit display
- Monitoring support for up to five extensions
- Eight function keys
- Four soft keys
- Ethernet Switch port for connecting a PC to the back of the phone
- InstaDial™ functionality in which calls are automatically transferred after digit collection stops and a configurable timeout period has expired
- Automatic Off-Hook Preference that lets users select which audio path (speakerphone or headset) is auto-activated when calls are sent or received
- Support for basic media encryption for calls inside a ShoreTel network
- Support for programmable buttons and extension monitoring
- Support for two-line caller ID display feature, which displays the caller name and number on two separate lines for in-coming calls and outbound calls
- Ability to load custom ring tones in .wav file format
- Built-in handset lifting functionality to support certain Plantronics wireless headset models

ShorePhone-IP560g

The ShorePhone-IP560g is a high-end phone designed for executives, assistants, and operators who handle high call volumes and share call flows with other users, yet require the benefit of 1000BaseT operations.

The ShorePhone-IP560g telephone is supported by the ShoreGear-120/24, ShoreGear 90, ShoreGear 90BRI, ShoreGear-60/12, ShoreGear 50, ShoreGear-40/8, ShoreGear 220T1/E1/T1A voice switches.

Key features include:

- Supports 10BaseT, 100BaseT, and 1000BaseT operations
- Six custom buttons that can be used for line appearance and other functions

- Eight function keys (Voice Mail, Transfer, Options, Conference, Directory, Intercom, Redial, Hold)
- Four soft keys
- Gigabit Ethernet Switch port for connecting a PC to the back of the phone
- Caller ID displayed for up to six calls simultaneously
- Backlit display
- Monitoring for up to five extensions
- InstaDial™ functionality in which calls are automatically transferred after digit collection stops and a configurable timeout period has expired
- Automatic Off-Hook Preference that lets users select which audio path (speakerphone or headset) is auto-activated when calls are sent or received
- Support for basic media encryption for calls inside a ShoreTel network
- Support for programmable buttons and extension monitoring
- Support for two-line caller ID display feature, which displays the caller name and number on two separate lines for in-coming calls and outbound calls
- Ability to load custom ring tones in .wav file format
- Built-in handset lifting functionality to support certain Plantronics wireless headset models

Installation Notes:

- The ShoreTel IP560g telephone requires a gigabit-compatible Power over Ethernet (POE) power supply that complies with 802.3af. The 560g phone is a Class 3 device with a maximum consumption of 8.2 watts. Please use 8.2 watts for capacity planning with Gig POE switches.
- The 560g phone is not compatible with the ShorePhone power adapter used with other ShoreTel phone models. The 560g model cannot be daisy-chained from the Button Box (BB24) as doing so may damage both the 560g IP phone and the BB24.
- The ShoreTel IP560g telephone requires the use of Category 5e or Category 6 Ethernet cables. Using Category 5 Ethernet cables is not officially supported and may lead to lower connection speed and/or performance issues during high-data transfer scenarios.
- transfer scenarios.

ShorePhone-BB24

The ShoreTel 24 IP Button Box provides additional shortcut functions for users of the IP212k/230/530/560/560g phones. The BB24 behaves like an additional set of 24 custom buttons in addition to the buttons that already exist on the IP212k/230/530/560/560g phone.

Key features include:

- Twenty-four custom keys
- Ability to assign up to 4 Button Boxes to an IP212k/230/530/560/560g phone
- Support for Programmable Buttons feature
- Ability for each user to define layouts for up to four BB24's thus allowing a maximum of about 100 programmable buttons for most phones (exact number varies depending on which phone the BB24 is connected)
- Custom buttons in which each is an LED-enabled hard key and has an associated 6 character label on the LCD
- Ethernet Switch port for connecting a PC to the back of the phone

- Ability to forward power to one additional unpowered device to support a daisy-chain configuration

For detailed information on available options and how to use them, refer to the *ShoreTel Programmable Buttons User Guide*.

For installation instructions, refer to the *ShoreTel 24 IP Button Box Quick Install Guide* (included with every BB24).

System Capacity

The ShoreTel 7.5 system can scale incrementally up to 10,000 ports (users and/or trunks) representing 200 ShoreGear voice switches over the entire system. The system is completely nonblocking and can support 5,000 simultaneous calls at a rate of 50,000 calls per hour.

Table 2-1 provides a summary of the ShoreTel 7.5 system capacity.

Table 2-1 ShoreTel 7.5 System Capacity

Component	Capacity	Notes
System		
Sites	500	Exact number varies by configuration.
Switches	60/site 500/system 100/server	Exact number varies by configuration.
Route Points	300	
Analog Ports	5,000	Exact number varies by configuration.
IP Phones	10,000	Exact number varies by configuration.
Simultaneous Calls	5,000	5,000 calling 5,000.
Busy Hour Call Completion	50,000	
Users		
Users	10,000	
– Port Based Users	5,000	
– IP Phone Users	10,000	
– Virtual Users	1,000	
User Groups	250	
Telephony Permissions	100	
Call Permissions	100	
Voice Mail Permissions	100	
Trunks		
Trunks	5,000	
Trunk Groups	250	
ShoreGear-120/24		
– Simultaneous calls	120	
– Busy hour call completion (Analog telephones)	1,440	1 call per minute x 60 minutes per hour x 24 ports.
– Busy hour call completion (IP telephones)	7,200	1 call per minute x 60 minutes per hour x 120 IP phones.
ShoreGear-60/12		
– Simultaneous calls	60	

Table 2-1 ShoreTel 7.5 System Capacity

Component	Capacity	Notes
– Busy hour call completion (Analog telephones)	720	1 call per minute x 60 minutes per hour x 12 ports.
– Busy hour call completion (IP telephones)	3600	1 call per minute x 60 minutes per hour x 60 IP phones.
ShoreGear-40/8		
– Simultaneous calls	40	
– Busy hour call completion (Analog telephones)	480	1 call per minute x 60 minutes per hour x 8 ports.
– Busy hour call completion (IP telephones)	2400	1 call per minute x 60 minutes per hour x 40 IP phones.
ShoreGear-T1		
– Simultaneous calls	24	
– Busy hour call completion	1,440	1 call per minute x 60 minutes per hour x 24 ports.
ShoreGear-E1		
– Simultaneous calls	30	
– Busy hour call completion	1,800	1 call per minute x 60 minutes per hour x 30 ports.
Servers		
Number of servers	21	1 main, 20 distributed (for voice mail, auto-attendant, messaging, directory, configuration services, and desktop call control). Each server is certified to support up to 1,000 users.
Media streams (per server)	254	Simultaneous voice mail sessions, for example.
Media streams (total)	5,334	21 servers x 254 media streams per server. For workgroups, the number is 254 total for the entire system, because workgroups can only exist on one server.
Voice Mail		
Mailboxes (total)	10,000	These can be distributed across the servers.
Mailboxes (per server)	3,000	
Storage	Unlimited	Restricted by the size of disk available (1 hour of voice mail per 30 MB of disk storage).
Auto-Attendant		
Menus (total)	256	Every server has every menu.
Hunt Groups		
Hunt groups per switch	8	
Total hunt group members per switch	16	
Workgroups		

Table 2-1 ShoreTel 7.5 System Capacity

Component	Capacity	Notes
Workgroups (total)	128	
Members per workgroup	300	Top down, round robin, and longest idle hunt pattern.
	16	Simultaneous ring.
Calls in Queue per Queue	254	Overflow is directed to the workgroup backup extension.
Call Detail Record		
Storage	1.5 GB ^a	500,000 workgroup calls, OR 1.5 million extension-to-extension calls, OR 1.0 million combined call records Implementing a database of this size typically requires 4.0 GB of disk space, including disk space for the main database (1.5 GB), the archive database (1.5 GB), and temporary space required to generate reports (1.0 GB).
Call Managers		
Call Managers (total)	10,000	
Call Managers (per server)	1,000	
Personal	10,000	
Advanced	10,000	
Workgroup Agent	500	
Workgroup Supervisor	128	
Operator	200	250 monitored extensions maximum.
Music on Hold (MOH)		
Music on Hold (MOH)	15	One switch can provide MOH for up to 15 switches per site.
Programmable Buttons		
IP phone buttons configured for extension monitoring (per switch)	1024	
Phones that can monitor an extension	32	

a. MySQL has a total capacity of 64TB.

Extension Monitoring Limitations

Note that there is a limit to the number of extensions that can be monitored, whether from a ShorePhone-BB24 device or from a ShorePhone IP212k/230/530/560/560g phone. This limitation is dependent on two factors:

- Update rate (every call causes one or more monitoring phones to be updated)
- Whether the monitoring phones are spread across one or more switches

ShoreTel switches support an update rate of 1 per second. This limit is independent of whether the monitored extensions are on the same switch or a different switch. If the monitored extensions are on a different switch, then IPDS is involved.

ShoreGear Voice Switch Feature Capacity

The ShoreGear voice switch is designed to handle the maximum load for the services it provides. Some features place a higher real-time load on the ShoreGear voice switch processor than others, and the use of these features must be carefully planned to take into account the impact on the processing power of a switch to handle call control signaling messages.

Table 2-2 offers some general guidelines for the number of extensions and group members for several commonly used features. Keep in mind that in addition to observing these limitations, you must stay below the real-time requirements of the switch itself.

Table 2-2 Feature Capacity

	Hunt Group	Bridged Call Appearance	Pickup Group	IP Phones
Extension	8	24	16	120
Members/ extensions	16	32 ^a	24	N/A
Stack size/ extensions	24	24	N/A	24
Total members on all extensions	16	N/A	80	N/A

a. phones on a switch monitoring the same extension

IP phones

Ringling a single user's IP phone is generates only one set of call control messages. However, as the call rate increases, the load on the processor also increases. Note that the call rate is the driving factor of load and not the length of a call. For instance, sixty calls placed over one hour, with each call lasting one minute, is a much higher load on the processor than a single call lasting one hour.

The ShoreGear-120/24 can support up to 120 IP phones. The point load for a single ShoreGear-120/24 is 7,200 calls per hour (1 call per minute for 120 phones over 60 minutes).

Hunt Groups

Hunt groups place a significantly heavier burden on the ShoreGear voice switch. For example, if you have a hunt group with 16 members, a single call into the hunt group will generate 16 simultaneous calls (assuming the feature is configured to simultaneously ring each hunt group member).

To extend this example, assume that the call stack size for this hunt group is set to 16, and 16 calls arrived at the same time, this would be equivalent to 256 calls (16 x 16) simultaneous calls. The number of hunt group members (as well as the call stack depth) is a multiplying factor for the signaling load that would be generated – thus, you should closely engineer hunt groups to ensure that the voice switch is not overburdened in order to ensure optimal performance.

You can have 8 hunt groups on a switch. Each hunt group can have up to 16 members and each hunt group can have a call stack of 24. The maximum number of members across all

groups on the switch also has to remain below 16. For instance, you could have one hunt group of 16 members or 2 hunt groups with 8 members each.

Bridged Call Appearances

With Bridged Call Appearances (BCA), the additional load on the processor is related to the transmission of call control signaling to the buttons that have been programmed on the ShoreTel IP phones. If a single BCA with a call stack of one is configured on a phone, this represents one load. However, if that same BCA were to appear on 24 different phones, that would represent 24 times more call signaling load than if the BCA were to appear on one phone.

The switch is capable of handling 24 BCAs, with a call stack depth of 24 and up to 32 phones monitoring a single BCA. If there are no hunt groups on the switch, it is possible for the switch to support up to 160 buttons programmed to monitor BCAs.

Pickup Groups

Pickup Groups place an additional load on the processor related to tracking the extensions in the group (although the actual real-time load is rather light and is not factored into the real time equation).

The switch is capable of supporting 16 pickup groups with a maximum of 24 members in the group. The total number of members in all groups on the switch must not exceed 80.

Real Time Capacity

In addition to the overall feature capacity limit, you should calculate the real-time load on the switch using the formula below:

$$\left(\sum_{n=1}^{No_HG} HG_StackSize(n) * HG_Members(n) \right) + (.5 * No_BCA_Monitoring_Lines) \leq 80$$

Thus, with the following configurations:

- a hunt group with four members and a call stack of four
- a second hunt group with eight members and a call stack of three
- ten phones, each monitoring four BCA

You would have room to spare:

HG 1	+	HG 2	+	BCAs	=	Total
4 x 4	+	8 x 3	+	(10 x 4)/2	=	60
16	+	24	+	20	=	60

*Part II: Conceptual Planning and
 System Design*

Planning and System Design

This chapter guides you through the initial design of your new voice communications system.

Checklist

The purpose of this chapter is to compile a high-level design of your system. The key components of the high-level design are:

Task Description	See
<input type="checkbox"/> Determine System Topology	page 3-2
<input type="checkbox"/> Determine Telephone Requirements	page 3-3
<input type="checkbox"/> Determine Trunk Requirements	page 3-5
<input type="checkbox"/> Determine Number of ShoreGear Voice Switches	page 3-6
<input type="checkbox"/> Determine WAN Connections	page 3-7

Recommendations

The following recommendations will assist you in designing your new voice communications system.

- Make sure you understand all the unique routing and hunting requirements of your current system.
- Be sure to account for all devices, including conference rooms, lobby phones, fax machines, and modems.
- Make sure you consider the changes to the call flow and overall system design that may drive the need for additional trunks.

Determine System Topology

The ShoreTel 7.5 system has a unique distributed call control software architecture that enables you to deploy ShoreGear voice switches and IP phones anywhere across your IP network. Even though multiple sites are supported, the ShoreTel 7.5 system is a single system with an extensive set of integrated applications and a single management image. The ShoreTel 7.5 system offers unmatched simplicity through this single image system, and delivers high availability, with no single point of failure, through its distributed architecture.

The first step in designing your voice network is to determine your overall network topology, which should provide the following information:

- **Sites and Users.** Number of sites and number of users at each site.
- **Headquarters and Distributed ShoreWare Servers.** Number of servers required, plus the name or IP address of all ShoreWare servers (main and distributed).
- **Teleworker Sites.** Number of teleworker installations and the type of telephones supported.
- **Telephone Requirements.** Number of telephones at each site (by type).
- **Trunk Requirements.** Number of trunks required for optimal performance.
- **ShoreGear Voice Switches.** What models are needed and how many of each model.
- **WAN Connections.** The number of WAN connections (per site) and complete service-level information.

See Chapter 9, “Network Requirements and Preparation,” for detailed information on planning your network for the ShoreTel 7.5 system.

Sites and Users

Your network topology diagram should provide an accurate inventory of the different physical sites and the number of users at each site.

Headquarters and Distributed ShoreWare Servers

The Headquarters ShoreWare server hosts the voice applications platform and the management web site, as well as the integrated voice applications. Typically, the Headquarters ShoreWare server is located at the largest location, containing the majority of users. Make special note of the main ShoreWare server on your topology diagram.

On your topology diagram, provide the following information about ShoreWare servers:

- Total number of servers (i.e. sum of servers at all sites).
- Number of servers at each site.
- The name and IP address of every server.

The ShoreTel 7.5 system also supports distributed voice application servers. Distributed servers help accomplish the following:

- Reduce bandwidth, because local users’ calls to voice mail are answered by the local voice mail application and do not go across the WAN.
- Increase system scale by extending the unified messaging and desktop call control services to additional users of the applications.

- Increase reliability by providing local support for some services and applications if a site loses connectivity with the Headquarters server.

Even though there are multiple servers, the ShoreTel 7.5 system provides a single image system across your entire network. The system is currently certified to support up to 21 servers, one at the headquarters site and up to 20 distributed servers. You should add a server at any site that exceeds 100 users. You must deploy a server for every 1,000 users.

The distributed voice applications platform can also provide an open applications platform for extending telephone services through TAPI-compliant third-party applications. A dedicated distributed server is required to host the third-party applications. This server is deployed like other distributed servers, except that it must not have voice mail users assigned to it.

The distributed voice application servers' Remote TAPI Service Provider relies on the call control information from the main server. To add reliability to your remote server, consider using redundant network paths to the main server.

For information about the ShoreWare server requirements, see Chapter 10, "Server Requirements."

Citrix and Windows Terminal Server

Citrix and Windows Terminal Server (WTS) technologies enable processing for multiple users to be aggregated on a single Windows computer. The single Windows computer is a process- and disk-sharing server for multiple users who have lightweight or thin graphics stations on their desktop. Citrix communicates between the server and clients using the ICA protocol, whereas Windows Terminal Server uses the RDP protocol.

For more information on configuring ShoreWare Call Manager clients on Citrix and WTS servers, see Appendix F, "ShoreWare Clients on Citrix and Windows Terminal Servers."

Teleworker Sites

In addition to the main locations, you can also deploy ShorePhone IP phones at employees' homes for the purpose of telecommuting. This allows teleworkers complete access to all the voice services on the network. The number and location of each teleworker IP phone should be noted on the topology diagram.

For information on configuring ShoreTel IP phones as teleworkers, see Chapter 15, "IP Phone Installation."

Telephone Requirements

The next task in the system design process is to determine your telephone requirements.

To determine your telephone requirements:

- Step 1** Count the telephones that are needed by counting the users installed on your current system. Make sure to include conference room telephones, lobby telephones, and telephones shared by multiple users.

Step 2 Determine the number of button boxes (ShoreTel BB24 devices) that will be needed for operators and receptionists.¹

Step 3 Determine the number of ports for fax machines and modems.

Step 4 If you are deploying IP phones, determine the number of telephones that will be IP phones and the number that will be analog phones.

Note: Certain users will require access to certain features, such as an operator needing a phone with programmable buttons. Therefore, you should consider which type of functions each user will need in order to select the most appropriate phone for that user.

See Chapter 2, “System Overview,” for information on ShorePhone telephone types.

Step 5 Consider your needs for additional telephone ports for third-party systems, including conference bridges and overhead paging systems.

See Chapter 8, “Telephone Planning and Ordering,” for more information about selecting telephones.

Step 6 Determine the number of user licenses you need.

Each user on the system requires a user access license. The types of user licenses are listed below:

- Extension and mailbox: Purchase of this license entitles the user to be assigned to both a physical extension and a ShoreTel voice mailbox.
- Extension-only: Purchase of this license entitles the user to be assigned to a physical extension, either via explicit assignment or via Office Anywhere.
- Mailbox-only: Purchase of this license allows entitles the user to be assigned to a ShoreTel voice mailbox.

An Extension-only user license is required for each conference room telephone, lobby telephone, fax machine, modem, and SoftPhone user. Each port on a ShoreTel Conference Bridge also requires a user license (included with the bridge), however, a user access license is not required for trunks and anonymous telephones.

For more information about user licenses, see Chapter 18, “Desktop Installation.”

Step 7 Fill in the telephone section of the Telephone and Trunk Planning Spreadsheet (Microsoft Excel Spreadsheet), shown in Figure 3-1.

The spreadsheet is available on the ShoreTel support web site for you to use in determining your telephone and trunk requirements. You must

1. The maximum number is 4 BB24 devices per IP212k/230/530/560/560g phone.

have Microsoft Excel to use this tool. If you are planning a multisite implementation, complete a telephone and trunk analysis for each site.

Telephones	Quantity	IP Phone Use	Analog Ports	IP Phones	T1 Channels	E1 Channels	Server Capacity
User Telephones	1,000	10%	900	100	-	-	1,000
Conference Room Telephones	20	10%	18	2	-	-	20
Lobby Telephones	2	10%	2	0	-	-	2
Modems	5	10%	5	1	-	-	5
FAX Machines	10	10%	9	1	-	-	10
Other	15	10%	14	2	-	-	15
Anonymous Telephones	20	10%	18	2	-	-	-
Virtual Users	50		-	-	-	-	50
Mailbox-only Users	75		-	-	-	-	-
Extension-only Users	50		-	-	-	-	-
Extension and mailbox Users	75		-	-	-	-	-
Sub-Total	1,322		965	107	0	0	1,102
Trunks							
Analog Trunks	10		10		-	-	-
T1 Trunks (24 Channels / Span)	2		-		48	-	-
T1 PRI Trunks (23 Channels / Span)	4		-		92	-	-
E1 PRI Trunks (30 Channels / Span)	0		-		-	0	-
Sub-Total			10		140	0	0
Total Trunks	150						
Total Physical Telephones	1,072						
				Trunks / Physical Telephones			
				14%			
ShoreGear Voice Switches							
ShoreGear-24	42						
ShoreGear-T1	6						
ShoreGear-E1	0						

Figure 3-1 Telephone and Trunk Planning Spreadsheet (Microsoft Excel)

Trunk Requirements

Trunks provide connectivity between users on the ShoreTel 7.5 system and the public switched telephone network (PSTN). In this next task in the system design process, you determine the number of trunks required.

The number of trunks required on your system varies, depending on the number of users and your specific application needs. It is important to size your trunking correctly because not having enough trunks can lead to blocked calls when all trunks are busy, and too many trunks can lead to wasted money on monthly access charges.

See Chapter 5, “Trunk Planning and Ordering,” for more information about trunk features, ordering, and installation.

You have several options for determining the number of trunks your site requires:

- Option 1** Review the number of trunks on your current system. In general, this is one of the best methods to gauge the number of trunks you need.
- Option 2** You can also request a traffic analysis from your service provider, interconnect, or telecom manager to understand your current trunk utilization. This method will help you understand your current usage and allow you to maintain the current service level.

Option 3 Visit a web site, such as www.erlang.com, to use a traffic calculator for determining your trunk requirements.

Option 4 Fill in the Trunks section of the spreadsheet shown in Figure 3-1 to determine the number of trunks you need. The spreadsheet automatically calculates the trunking ratio.

Consider Table 3-1 and the following:

- Larger locations can typically use lower-density trunking (15%).
- Smaller locations need higher-density trunking (50%).
- Some applications, such as call centers, can demand higher-density trunking (50%).

Table 3-1 Trunk Density

Trunk Density	Trunks/Users %
Low	15%
Average	30%
High	50%

NOTE When planning trunks, consider the call volume for your workgroups or ACD groups. Since there is generally a queuing solution in place for ACD calls, the number of trunks required should be based on the full utilization of the expected number of agents and sufficient trunks for the expected number of waiting callers.

Determine Number of ShoreGear Voice Switches

The ShoreTel 7.5 system is a software solution that runs on standard platforms across the network equipment in your enterprise. The ShoreGear hardware portfolio offers a broad family of voice switches to meet the needs of our different customers. Each ShoreGear voice switch connects to your IP network using a 10/100M auto-sensing Ethernet port:

- The **ShoreGear-120/24** provides 8 universal telephone and trunk ports with 16 telephone ports. It also supports up to 120 IP phones.¹
- The **ShoreGear-90** provides 4 analog extensions and 8 analog loop start trunks for a total of 12 analog ports.
- The **ShoreGear-60/12** provides 8 universal telephone and trunk ports with 4 telephone ports. It also supports up to 60 IP phones.
- The **ShoreGear-50** provides 2 analog extensions and 4 analog loop start trunks for a total of 6 analog ports..
- The **ShoreGear-40/8** supports 8 analog ports (2 universal telephone/trunk ports, 2 loop-start trunk-only ports, and 4 telephone ports), or up to 40 IP phones.

1. If you are installing the ShoreTel Conference Bridge, verify that you will have enough switches (i.e. available) IP ports, to support the bridge. Note that one physical port must be reserved for every five SIP trunks that will be used.

- The **ShoreGear-T1** provides a single T1 PRI interface to the PSTN or legacy PBX system.
- The **ShoreGear-E1** provides a single E1 PRI interface to the PSTN or legacy PBX system.
- The **ShoreGear-220T1** provides support for up to 100 ShoreTel IP Phones (five IP phones per IP phone port) and 1 T1 digital trunk.
- The **ShoreGear-220E1** provides support for up to 70 ShoreTel IP Phones (five IP phones per IP phone port) and 1 E1 digital trunk.

To determine the number of voice switches:

- Fill in the ShoreGear voice switches section in the Telephone and Trunk Planning Spreadsheet (Figure 3-1 on page 3-5) to calculate the number of voice switches required.

When you compute the user and trunk information in the spreadsheet, the number of switches for each site is provided.

See Appendix A, “International Planning and Installation,” for more information about which voice switches and features are supported in countries other than the United States.

WAN Connections

To complete your system design, the final step is to identify your network connectivity. You should identify the following for the network connections to each site:

- Bandwidth
- Latency
- Jitter
- Packet Loss

C H A P T E R 4

Routing Calls

This chapter helps you identify the desired routing for inbound and outbound calls, so that you can determine your requirements for configuration and trunking.

When installing a voice communications system, one of the most important decisions you must make is how to route incoming calls. This includes calls made to your company, an individual employee, or a group of employees, such as sales or customer support. It is important to consider not only how calls are initially routed, but also how they are routed when the person or group is not available to take the call. Will calls be transferred to the Auto-Attendant, the operator, an off-site number, a pager, or a cell phone? The ShoreTel 7.5 system is highly flexible and supports numerous methods to route incoming calls.

Routing Option	See
<input type="checkbox"/> Direct All Calls to an Auto-Attendant	page 4-3
<input type="checkbox"/> Direct All Calls to a Live Operator	page 4-6
<input type="checkbox"/> Direct All Calls to Extensions	page 4-9
<input type="checkbox"/> Blended Call Routing	page 4-11
<input type="checkbox"/> Analyze Outbound Call Routing	page 4-13

In addition, you must consider your outbound call routing plan. You should have trunks at every site that supports both outbound and inbound calling.

This chapter helps you design the call flow of your new voice communications system. See Chapter 3, “Planning and System Design,” for information about other aspects of designing your new voice communications system.

NOTE If you are installing a ShoreTel Contact Center Solution, call routing within the contact center is configured separately and is not covered in this guide. For more information on the ShoreTel Contact Center Solution, see the *ShoreTel Contact Center Solution Administration Guide*.

Recommendations

Consider the following recommendations when designing your call flow plan:

- Determine how calls should reach employees and workgroups. You need to identify the desired call routing for inbound calls at each site.
- Identify contingencies, such as alternate plans in the event that the receptionist has an unplanned absence, or the physical phone fails. For example, creating hunt groups can ensure an operator is available if the receptionist or workgroup is unavailable.
- Consider the inter-site call flow, such as your operator's or receptionist's role in handling inbound calls, and the role of others who are not physically present at the main site.
- Identify call flow early. Do not wait until the last minute, or try to identify the call flow the day of cut-over.
- Interview the key members of your organization (workgroups, operators, assistants, and executives) to determine their individual preferences and needs, and make sure they agree with any decisions that affect their respective areas.
- Create an off-hours call routing plan.

Hunt Groups

Hunt groups allow you to route calls to a list of extensions. Hunt groups can be accessed through an extension, DID, and/or DNIS. Hunt groups are supported by ShoreGear switches and remain available even when connectivity to the Headquarters server is lost. A single switch can host up to 8 hunt groups and a maximum of 16 extensions total per switch. A hunt group can be used as the backup destination for an operator or workgroup, so that basic hunting occurs even when the operator or workgroup is not reachable. To maximize reliability, assign hunt groups to a switch close to the majority of the members and/or trunks associated with the hunt group.

Hunt groups can be used for:

- Backup Routing for a workgroup
Hunt groups can be used when the workgroup server is not reachable because of a network outage or admission control. When the hunt group is set to offer each member a single call at a time, then call offering is similar to a workgroup.
- Hunt Group as a Call Forward Destination
In a small office where individuals generally receive calls directly, users may want someone in the office to answer calls when they are unable to answer. Hunt groups can provide alternate destinations in this case.
- Distribution of Calls to Backup Operators
A hunt group can provide backup operators for the primary operator who handles calls to a main company number.
- Common Line Monitoring
A hunt group can be used for line monitoring. For example, several operators may wish to monitor the same line and all have an opportunity to answer calls at the same time.

Direct All Calls to an Auto-Attendant

You can direct all inbound calls to the automated attendant, and prompt the calling party to route the call, based on menu options. Auto-attendant answering is typically used by smaller companies and smaller locations that do not choose to use direct inward dial (DID) numbers. See Figure 4-1 on page 4-5 for an illustration of auto-attendant call flow.

Organize the auto-attendant with options for various departments. In addition, include an “out” for callers if they must speak to a live attendant or have a rotary telephone. This destination must be one that will always be answered. In many cases, it is a receptionist’s extension that is staffed at all times, or a night chime that can be answered by any employee. If you route calls to a receptionist’s position that is not always staffed or the receptionist needs to be mobile, consider installing a cordless telephone for the receptionist to wear while roaming around the office. If this is not an option, make sure the receptionist’s call handling modes are set up appropriately.

Trunk Considerations

An auto-attendant menu can be reached through analog loop-start, digital loop-start, and T1/E1 PRI trunks by pointing the trunk group at the desired menu. You can also reach a specific menu using DID or DNIS entries received over analog wink-start, digital wink-start, or T1/E1 PRI trunks.

The ShoreTel 7.5 system supports International Caller ID, Caller ID Name, Caller ID Number, ANI, and DNIS. The Caller ID and trunk group or DNIS information is provided to the user to assist in answering the call.

Call Routing and Collecting Caller ID Information

The switch delays each inbound loop-start call by 1.5 rings to collect caller ID information before ringing the user’s telephone. This allows caller ID information to reach the user’s client at the time the call rings the extension, rather than *after* it rings the extension.

NOTE Features available on trunks vary by trunk type. See Chapter 5, “Trunk Planning and Ordering,” for more information.

After-Hours Call Routing

For after hours, weekends, and holidays, consider how your call flow will change. Typically, a different prompt is played, since callers are routed directly to voice mail rather than to workgroups or the operator.

Example of Auto-Attendant Call Routing

In the call flow example shown in Figure 4-1, all calls are received by the auto-attendant. The calling party can choose to be directed to:

- The support workgroup by dialing a digit.
Calls are presented to the support workgroup with a mailbox that provides coverage. The calling party can dial “0” in the mailbox to reach the workgroup assistant, or “9” to return to the auto-attendant.

- An employee using Dial by Number or Dial by Name.
Calls are presented to the employee with a mailbox that provides coverage. The calling party can dial “0” in the mailbox to reach the employee’s personal assistant, or “9” to return to the auto-attendant.
- The operator by dialing the digit 0.
Calls are presented to the operator. If the operator does not answer, a backup operator provides coverage using the operator’s call handling modes. If the backup operator does not answer, a mailbox provides coverage, and the calling party can dial “0” in the mailbox to reach the operator’s personal assistant, or “9” to return to the auto-attendant.

In this example, the workgroup, users, and operator route calls directly to voice mail after hours.

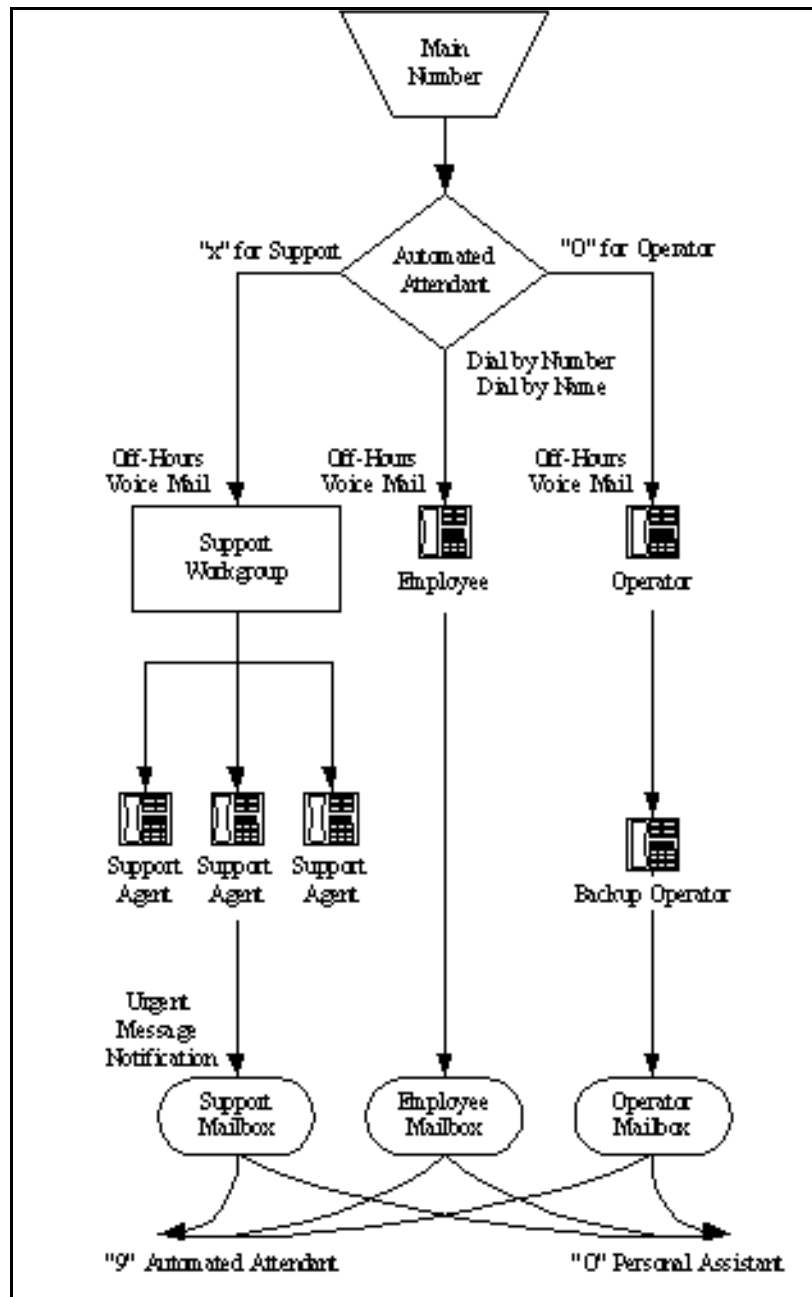

Figure 4-1 Auto-Attendant Call Routing

Direct All Calls to a Live Operator

Some companies choose to answer all inbound calls during business hours with a live operator to give callers a more personal experience. If you use a live operator, the most important thing to remember is that the operator's telephone must always be staffed. ShoreTel recommends the following:

- Use the Operator Call Manager (OCM) software, because the standard telephone without OCM manages only a single call at a time. When a second call arrives, using the Flash button invokes call waiting, generating a swap hold situation in which calls cannot be transferred. This problem is eliminated when you use the Operator Call Manager.
- If the organization is a large one, consider using the ShorePhone-BB24 button box. The button box provides additional shortcut functions for the ShorePhone IP212k/230/530/560/560g phones. The button box behaves like an additional set of 24 custom buttons that can be used by the operator to quickly and easily route calls to executives and to other employees who receive a high volume of phone calls. A maximum of 4 BB24 devices can be connected to each IP212k/230/530/560/560g phone.
- If the operator does not receive a lot of telephone calls and is required to roam around the office to deliver mail, pick up faxes, make copies, and so on, a two-line 2.4 GHz cordless telephone can be used. The first line is reserved for incoming calls, while the second line is the operator's personal extension.
- Create hunt groups to ensure someone is always available to take an incoming call.
- You can choose to have calls initially routed to the operator and then forwarded to the auto-attendant after a fixed number of rings.

Operators work in either of two modes:

- Answer all calls and transfer them to the appropriate destination.
- Answer all calls and hold them until the parties are found.

If your operator works in the second mode, you should consider installing an overhead paging system or should consider using the Paging Groups feature (see the *ShoreTel 7.5 Administration Guide* for details on Paging Groups).

The ShoreTel 7.5 system supports single-zone overhead paging on a per-site basis, using the audio output jack on the ShoreGear-120/24, ShoreGear-60/12, and ShoreGear-40/8. When you need multiple-zone paging, please use ShoreLink, ShoreTel's online knowledge base, to access the application note on paging on ShoreTel's web site at www.shoretel.com.

Trunk Considerations

The operator can be reached through analog loop-start, digital loop-start, and T1/E1 PRI trunks by pointing the trunk group directly at the operator. You can also reach the operator using DID or DNIS entries received over analog wink-start, digital wink-start, or T1/E1 PRI trunks.

The ShoreTel 7.5 system supports International Caller ID, Caller ID Name, Caller ID Number, ANI, and DNIS. The Caller ID and trunk group or DNIS information is provided to the user to assist in answering the call.

NOTE Features available on trunks vary by trunk type. See Chapter 5, "Trunk Planning and Ordering," for more information.

After-Hours Call Routing

If you route all calls to the operator's extension, auto-attendant scheduling does not apply; only those calls routed to the auto-attendant use the schedule. Therefore, if you want to use the off-hours, holiday, and custom schedules, set the operator's call handling mode to forward all calls to the auto-attendant when the operator is unavailable.

Example Using Hunt Groups

To route calls to a prioritized list of backup operators, create hunt groups with users who can serve as backup operators. In this scenario, a primary operator who handles calls to a main company number requires one or more secondary operators to receive the calls when the primary operator becomes too busy.

To create a hunt group to back up the primary operator:

- Create a hunt group with backup operators.
- Enter the main operator and all the backups as members of the hunt group in the order in which they are to serve as backups.
- Set the hunt group for multiple calls to be hunted to a given member.
- Set the call stack size for each of the users to control the number of calls he or she can receive.

When there are incoming calls to the hunt group, the primary operator is offered the calls first. The operator may be offered multiple calls concurrently up to the limit of his or her call stack. If a member's call stack is full, the member is skipped and that particular call is not be offered again (unless the hunt group is set to hunt forever and no member picks up the call before the member is reached again in the hunt list).

If a member of the operator group does not answer the hunt call, the call is offered to the next member after the number of configured rings. Thus, even if the primary operator has room on his or her call stack, the call is offered to the next member in the list when the operator does not answer the call in time.

For more information on Hunt Groups, see "Hunt Groups" on page 11-20.

Example of Operator Call Routing

In the example call flow shown in Figure 4-2 on page 4-8, all calls are received by the operator, who then transfers the calls to the appropriate destination.

- Calls are transferred to the support workgroup with a mailbox that provides coverage.
The calling party can dial "0" in the mailbox to reach the workgroup assistant, or "9" to return to the auto-attendant.
- Calls are transferred to the employees with a mailbox that provides coverage.
The calling party can dial "0" in the mailbox to reach his or her personal assistant, or "9" to return to the auto-attendant.
- If the operator does not answer, a backup operator provides coverage, using the operator's call handling modes.

If the backup operator does not answer, a mailbox provides coverage and the calling party can dial “0” in the mailbox to reach the operator’s personal assistant, or “9” to return to the auto-attendant.

In this example, after-hours call routing is handled by an auto-attendant in a very similar fashion to the previous example (Figure 4-1 on page 4-5). To start after-hours call handling, the operator changes his or her call handling mode. This can be done automatically using Microsoft Outlook Calendar in conjunction with Automated Call Handling (although it does require the operator’s personal computer to remain connected with Microsoft Outlook running on it).

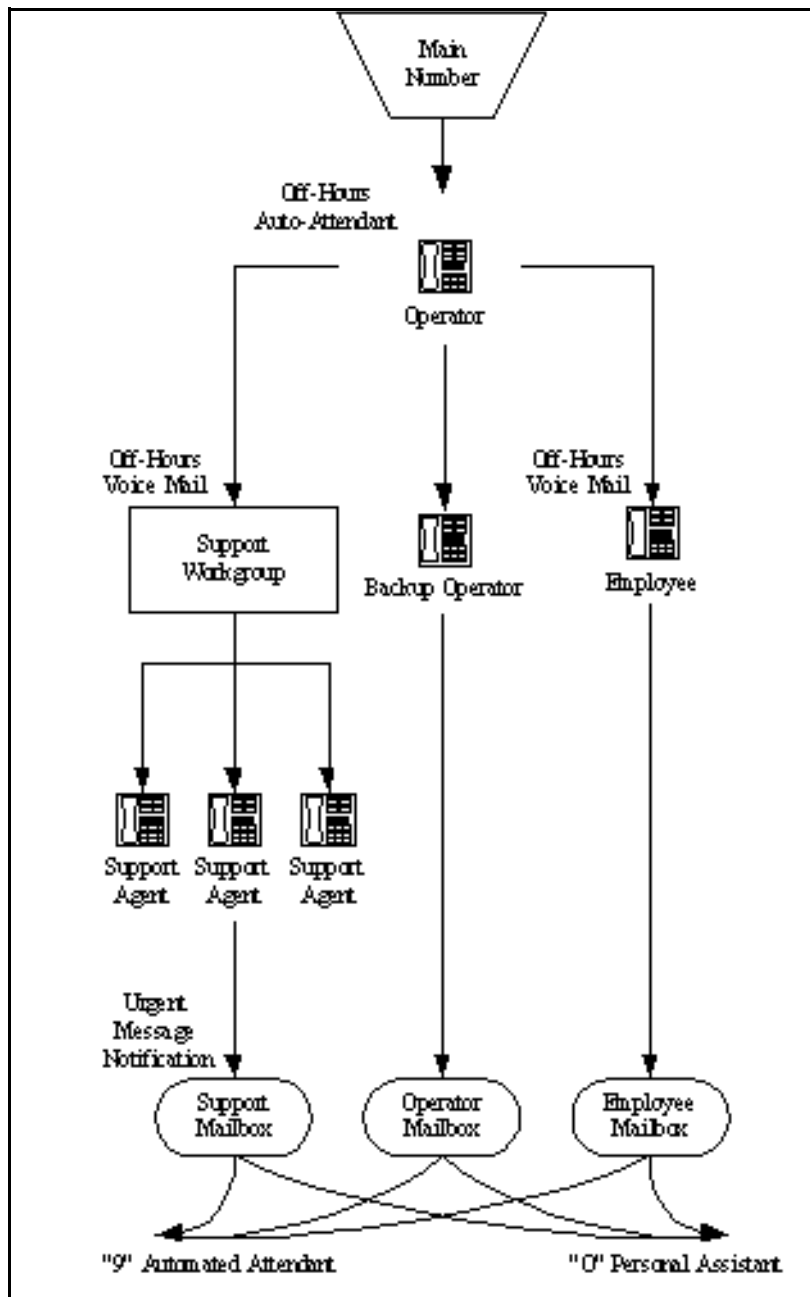

Figure 4-2 Operator Call Routing

Direct All Calls to Extensions

ShoreTel recommends using Direct Inward Dial (DID) trunks so that callers can dial extensions directly without having to go through the operator. This provides the most efficient, professional call handling experience to your customers.

In the event that an individual is not available, preconfigured call handling modes route callers. This routing might include a cellular telephone, a pager, an alternate extension, or a personal assistant. Additionally, consider using the voice mail notification capabilities of the ShoreTel 7.5 system when employees are not able to answer the telephone but need to stay in touch.

Even if you choose to direct all calls to extensions, you should still configure the auto-attendant for Dial by Number, Dial by Name, and zero out to an operator.

Trunk Considerations

When using Direct Inward Dial, you must use analog wink-start, digital wink-start, SIP or T1/E1 PRI trunks. The ShoreTel 7.5 system can receive Automatic Number Identification (ANI) over analog and digital wink-start trunks as well as Caller ID Number over T1/E1 PRI.

NOTE Features available on trunks vary by trunk type. See Chapter 5, “Trunk Planning and Ordering,” for more information.

After-Hours Call Routing

By routing all calls to the individual extensions, each individual user and workgroup defines its after-hours call handling.

Example of Direct Inward Dial Call Routing

In the illustration shown in Figure 4-3 on page 4-10, all calls are received by workgroups or by individuals.

- Calls are routed directly to the support workgroup with a mailbox that provides coverage.
The calling party can dial “0” in the mailbox to reach the workgroup assistant or “9” to return to the auto-attendant.
- Calls are routed directly to the employees with a mailbox that provides coverage.
The calling party can dial “0” in the mailbox to reach his or her personal assistant, or “9” to return to the auto-attendant.
- An operator provides limited call handling functions from individual mailboxes or the automated attendant.

In this example, after-hours call routing is received by the workgroups and individual employees.

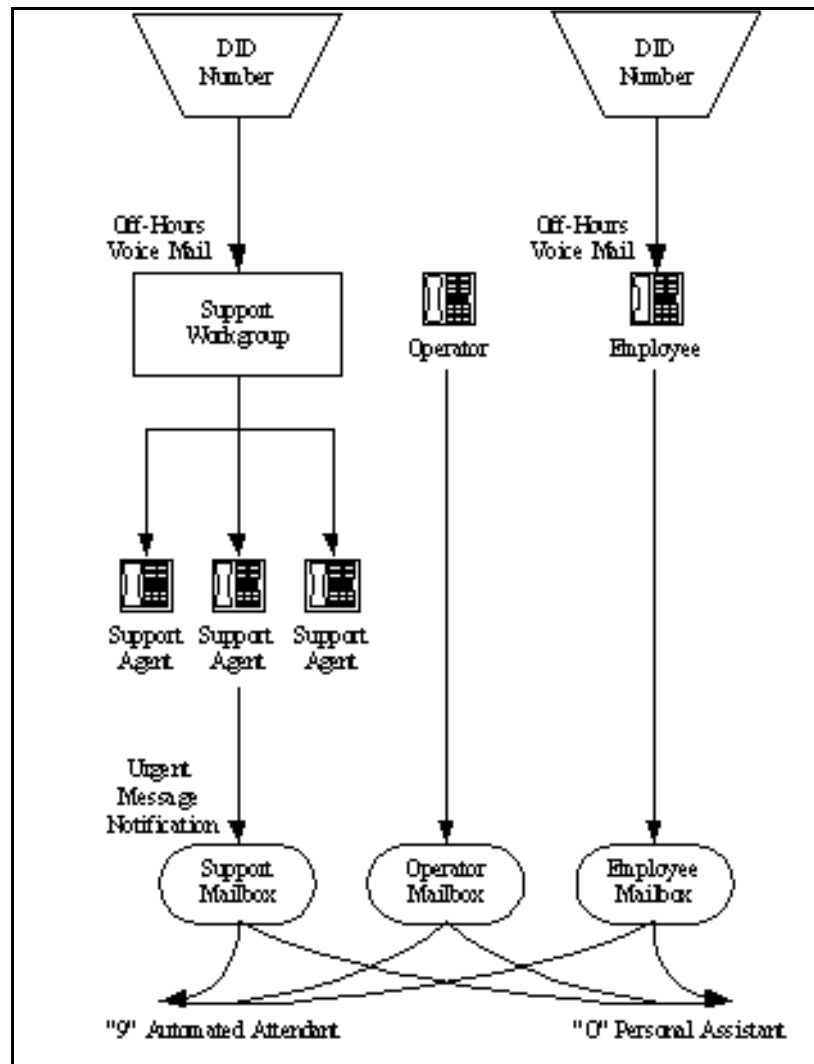

Figure 4-3 Direct Inward Dial Call Routing

Blended Call Routing

Communication systems typically use a mix of automated, live, and DID call routing to maximize user satisfaction as well as efficiency and flexibility. This usually includes taking a published main telephone number and routing it to the auto-attendant, as well as installing DID lines that route calls directly to different workgroups and individual employees.

Trunk Considerations

An auto-attendant menu can be reached through analog loop-start, digital loop-start, SIP, and T1/E1 PRI trunks by pointing the trunk group at the desired menu. You can also reach a specific menu using DID or DNIS entries received over analog wink-start, digital wink-start, or T1/E1 PRI trunks.

The operator can be reached through analog loop-start, digital loop-start, and T1/E1 PRI trunks by pointing the trunk group directly at the operator. You can also reach the operator using DID or DNIS entries received over analog wink-start, digital wink-start, or T1/E1 PRI trunks.

The ShoreTel 7.5 system supports International Caller ID, Caller ID Name, Caller ID Number, ANI, and DNIS. The Caller ID and trunk group or DNIS information will be provided to the user to assist in answering the call.

When using Direct Inward Dial, you must use analog wink-start, digital-wink start, or T1/E1 PRI trunks. The ShoreTel 7.5 system can receive Automatic Number Identification (ANI) over analog and digital wink-start trunks as well as Caller ID Number over T1/E1 PRI.

NOTE Features available on trunks vary by trunk type. See Chapter 5, “Trunk Planning and Ordering,” for more information.

After-Hours Call Routing

For after hours, weekends, and holidays, you should consider how your call flow will change. Typically, a different prompt should be played, since callers are routed directly to voice mail rather than to workgroups or the operator.

If you route all calls to the operator’s extension, auto-attendant scheduling does not apply; only those calls routed to the auto-attendant use the schedule. Therefore, when you want to use the off-hours, holiday, and custom schedules, set the operator’s call handling mode to forward all calls to the auto-attendant when unavailable.

By routing all calls to the individual extensions, each individual user and workgroup defines its after-hours call handling.

Example of Blended Call Routing

In the example shown in Figure 4-4 on page 4-12, a mix of inbound call routing is used.

- Calls are routed directly to the support workgroup using DID and DNIS entries and routed through the auto-attendant with a mailbox that provides coverage.

The calling party can dial “0” in the mailbox to reach the workgroup assistant, or “9” to return to the auto-attendant.

- Calls are routed directly to the employees using DID and routed through the auto-attendant using Dial by Number and Dial by Name with a mailbox that provides coverage.

The calling party can dial “0” in the mailbox to reach his or her personal assistant, or “9” to return to the auto-attendant.

- An operator provides limited call handling functions from individual mailboxes or the auto-attendant.

In this example, after-hours call routing changes at the auto-attendant and for each of the workgroups, employees, and the operator, because each workgroup defines its own after-hours call routing.

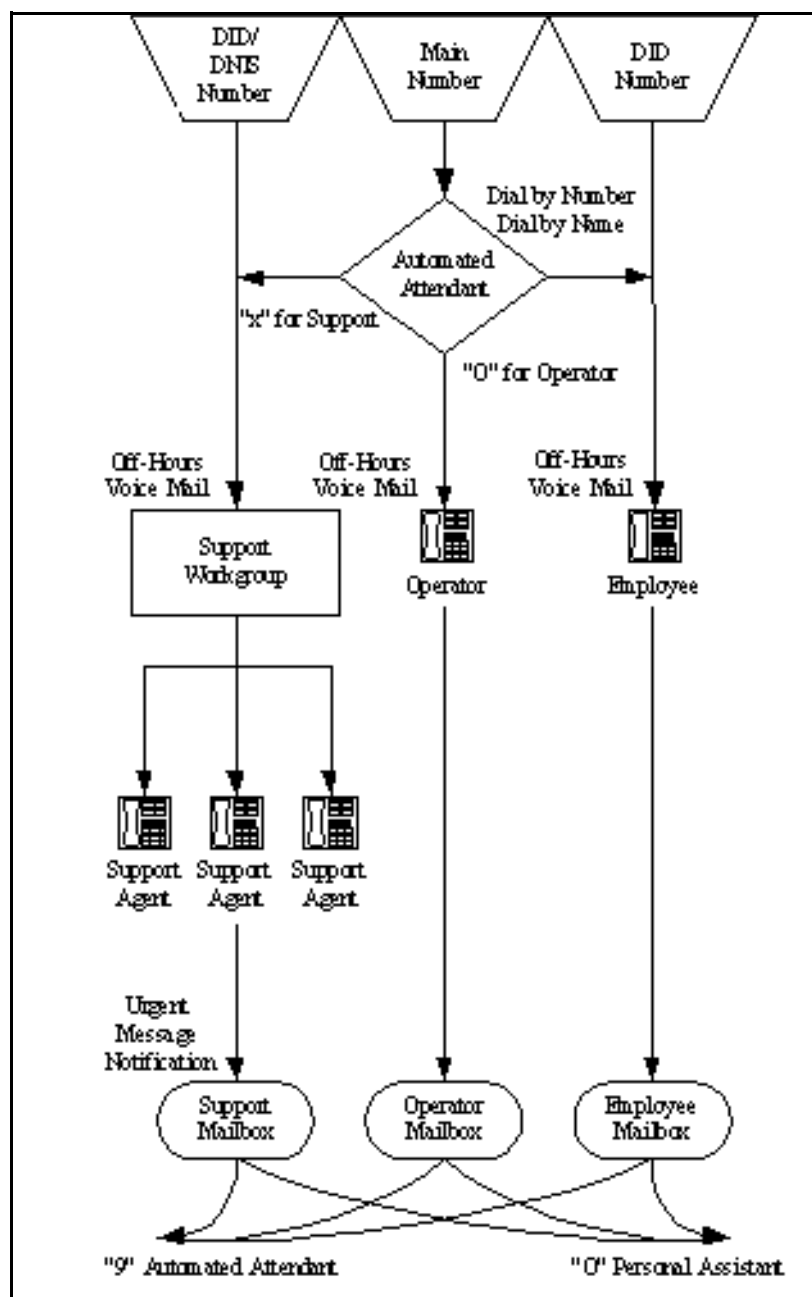

Figure 4-4 Blended Call Routing

Analyze Outbound Call Routing

In general, you should have trunks at every site that support both outbound and inbound calling. Here are some general comments about outbound trunking:

- ISDN PRI provides the most feature-rich inbound and outbound calling experience.

This includes the support for Caller ID, DID, and DNIS. Caller ID Number is supported for both inbound and outbound calls. Caller ID Name is supported only on inbound NI-2 trunks (with the exception of outbound calls to off-system extensions).

- SIP trunks can be used to place outbound calls.
- Analog wink-start trunks do not support outbound calls.
- You may want to purchase some analog loop-start trunks for emergency dial tone in case of total power failure. For more information, see “Analog Loop-Start Trunks (North America)” on page 5-2.
- Calls can be automatically routed across your wide area network (WAN) using the Network Call Routing feature. (This allows users to access local and “nearby” area codes at one site from another site.)
- You need to plan for emergency calls (such as 911 in the United States) on your voice system.

The ShoreTel 7.5 system supports all the necessary signaling for emergency calls. Please see the appendix on emergency 911 operations in the *ShoreTel 7.5 Administration Guide* for information on how to configure your system for emergency calls.

NOTE If your system uses three-digit extensions, ShoreTel recommends that you do not assign x11 extensions to users.

For more information, see Chapter 5, “Trunk Planning and Ordering,” and Chapter 6, “Dialing Plan.”

Trunk Planning and Ordering

This chapter explains the features and functionality of trunks on the ShoreTel 7.5 system, so you can plan and order your service. It includes the following information:

- An overview of the trunk types supported on the ShoreTel 7.5 system
- A description of each trunk feature
- Traffic calculations
- Trunk ordering and order form

Checklist

You must complete the following tasks before proceeding to the next chapter:

Task Description	See
<input type="checkbox"/> Reviewing and Selecting Trunk Types	page 5-2
<input type="checkbox"/> Understanding Trunk Features	page 5-7
<input type="checkbox"/> Performing Traffic Calculations	page 5-10
<input type="checkbox"/> Ordering Telephone Service	page 5-12

Recommendations

The following recommendations assist you in determining your trunk requirements and ordering your trunks from your service provider:

- Make sure you order telephone service early. T1 and PRI service can take up to one or two months to install.
- If you are reusing Centrex lines, be sure to change your old service and remove call waiting, call forwarding, and voice mail.
- When provisioning PRI service, be sure to confirm the protocol being used (NI-2, 4ESS, 5ESS, or DMS-100). Make sure that neither NFAS nor the Call-by-Call feature of the 4ESS is being used, since they are not supported on the ShoreTel 7.5 system.

Reviewing and Selecting Trunk Types

Trunks provide a connection from the ShoreTel 7.5 system to a service provider for the purpose of making and taking calls to and from external parties.

The ShoreTel 7.5 system supports seven different ShoreGear voice switches and six different trunk types tailored for specific applications. Table 5-1 shows which trunk types are supported on which voice switch. The next section provides more detailed information about the various trunk features.

Table 5-1 Supported Trunk Types

Voice Switch	Analog Loop-Start (N.Am.)	Analog Loop-Start (EMEA)	Digital Loop-Start	Analog Wink-Start	Digital Wink-Start	T1 PRI	E1 PRI	SIP	BRI
ShoreGear-120/24	Yes	No	No	Yes	No	No	No	Yes	No
ShoreGear-90	Yes	Yes	No	Yes	No	No	No	Yes	No
ShoreGear-90BRI	No	No	No	No	No	No	No	Yes	Yes
ShoreGear-60/12	Yes	No	No	Yes	No	No	No	Yes	No
ShoreGear-50	Yes	Yes	No	Yes	No	No	No	Yes	No
ShoreGear-40/8	Yes	No	No	Yes	No	No	No	Yes	No
ShoreGear-220T1	No	No	Yes	No	Yes	Yes	No	Yes	No
ShoreGear-220T1A	Yes	No	Yes	No	Yes	Yes	No	Yes	No
ShoreGear-220E1	No	No	No	No	No	No	Yes	Yes	No
ShoreGear-T1	No	No	Yes	No	Yes	Yes	No	No	No
ShoreGear-E1	No	No	No	No	No	No	Yes	No	No

Analog Loop-Start Trunks (North America)

Analog loop-start trunks are supported on the ShoreGear-120/24, ShoreGear 90, ShoreGear-60/12, ShoreGear 50, ShoreGear-40/8 and ShoreGear 220T1A voice switches. These trunks are typically used for inbound calls to a main telephone number that are directed to an auto-attendant menu, company operator, or workgroup. A caller can route a call from the auto-attendant to a user extension by entering the extension number or by spelling the user's name from the telephone keypad. Analog loop-start trunks are also used to make outbound calls.

Analog loop-start trunks support:

- Inbound calls
- Outbound calls
- Caller ID number
- Caller ID name
- Caller ID blocking

Analog provisioning is provided by the loop-start protocol and Dual-Tone Multi-Frequency (DTMF) signaling.

Analog loop-start trunks are used to provide power-fail transfer to selected telephones—for instance, to the operator, security station, executives, and so on. When there is a complete power failure, including loss of UPS power backup, ports 8 and 9 on the ShoreGear-120/24 and ShoreGear-60/12, ports 4 and 5 on the ShoreGear-40/8, will be connected through a power-fail transfer feature. The ShoreGear-50¹ and ShoreGear-90 have the power-fail transfer between ports 1 and 12. This power-fail transfer ability provides a dial tone for making and taking critical calls in the event of power failure.

NOTE Centrex lines are analog lines that can be used as analog loop-start trunks on the ShoreGear-120/24, ShoreGear 90, ShoreGear-60/12, ShoreGear 50, and ShoreGear-40/8 voice switches. Your organization may already have these installed, and want to use them instead of ordering new loop-start trunks. If you have Centrex lines and do not want to change your primary company telephone number, you can keep Centrex lines. Centrex lines support Caller ID. Be sure to remove the Centrex features, including call waiting, call forward, and voice mail.

NOTE ShoreWare was originally designed to support analog trunks in the U.S. However, ShoreWare 7.5 expands trunk support outside of the US to EMEA. EMEA analog loop start trunk support, based on the TBR 21 standard, is supported on all ShoreWare voice switches developed in ShoreWare Version 7 and all subsequent releases. BT type 1 (on hook) caller ID support is based on SIN 227 and SIN 242 standards in the UK.

Analog Loop-Start Trunks (EMEA)

Analog Loop-Start trunks are supported in Europe, the Middle East, and Africa, and are based on the TBR 21 standard.

Analog Loop-Start Trunks (EMEA) are supported on the ShoreGear 90, ShoreGear 50 and ShoreGear 220T1A. These trunks are typically used for inbound calls to a main telephone number that are directed to an auto-attendant menu, company operator, or workgroup. A caller can route a call from the auto-attendant to a user extension by entering the extension number or by spelling the user's name from the telephone keypad. Analog loop-start trunks are also used to make outbound calls.

Analog loop-start trunks (EMEA) support:

- Inbound calls
- Outbound calls²

Analog provisioning is provided by the loop-start protocol and Dual-Tone Multi-Frequency (DTMF) signaling.

Analog loop-start trunks are used to provide power-fail transfer to selected telephones—for instance, to the operator, security station, executives, and so on. When there is a complete power failure, including loss of UPS power backup, the ShoreGear 50³, ShoreGear 90 and ShoreGear 220T1A have the power-fail transfer between ports 1 and 12. This power-fail transfer ability provides a dial tone for making and taking critical calls in the event of power failure.

NOTE Centrex lines are analog lines that can be used as analog loop-start trunks on the ShoreGear switches. Your organization may already have these installed, and

1. On the ShoreGear-50 only ports 1-4 and 11-12 work.
2. BT type 1 (on hook) caller ID support is based on SIN 227 and SIN 242 standards in the UK.
3. On the ShoreGear-50 only ports 1-4 and 11-12 work.

want to use them instead of ordering new loop-start trunks. If you have Centrex lines and do not want to change your primary company telephone number, you can keep Centrex lines. Centrex lines support Caller ID. Be sure to remove the Centrex features, including call waiting, call forward, and voice mail.

Digital Loop-Start Trunks

Digital loop-start trunks are supported on the ShoreGear-220T1, ShoreGear-220E1, and ShoreGear-T1 voice switches. These trunks are typically used for inbound calls to the main telephone number that are directed to an auto-attendant menu, company operator, or workgroup. A caller can route a call from the auto-attendant to a user extension by entering the extension number or by spelling the user's name from the telephone keypad. Digital loop-start trunks are also used to make outbound calls.

Digital loop-start trunks support:

- Inbound calls
- Outbound calls
- Caller ID number
- Caller ID name
- Caller ID blocking

Digital provisioning is provided by the loop-start protocol and Dual-Tone Multi-Frequency (DTMF) signaling. The ShoreGear-T1 supports ESF or D4 framing formats and B8ZS or AMI line coding.

Analog Wink-Start Trunks (Analog DID)

Analog wink-start trunks are supported on the ShoreGear-120/24, ShoreGear 90, ShoreGear-60/12, ShoreGear 50, and ShoreGear-40/8 voice switches. These trunks allow external callers to dial a user's phone number directly, without having to use an auto-attendant or operator. Analog wink-start trunks support only inbound calls; they are not capable of handling outbound calls.

Analog wink-start trunks support:

- Inbound calls (outbound calls are not supported)
- ANI
- DID
- DNIS

Analog provisioning is provided by the wink-start protocol and Dual-Tone Multi-Frequency (DTMF) signaling.

If ANI is being used, the star (*) key must be used to delimit the ANI digits from the DID/DNIS digits—that is:

- <DID>
- <DNIS>
- *<ANI>*<DID/DNIS>*

Digital Wink-Start Trunks

Digital wink-start trunks are supported on the ShoreGear-T1 voice switch. These trunks allow external callers to dial a user's phone number directly, without having to

use an auto-attendant or operator. Digital wink-start trunks support both inbound and outbound calls.

Digital wink-start trunks support:

- Inbound calls
- Outbound calls
- ANI
- DID
- DNIS

Digital provisioning is provided by the wink-start protocol (often called E&M wink-start) and Dual-Tone Multi-Frequency (DTMF) signaling. The ShoreGear-T1 supports ESF or D4 framing formats and B8ZS or AMI line coding.

If ANI is being used, the star (*) key must be used to delimit the ANI digits from the DID/DNIS digits—that is:

- <DID>
- <DNIS>
- *<ANI>*<DID/DNIS>*

BRI Trunks

BRI trunks are supported on the ShoreGear-90BRI voice switch. They are flexible trunks that support both inbound and outbound calls.

PRI trunks support:

- Inbound calls
- Outbound calls
- DID
- DNIS
- Caller ID number
- Caller ID name is supported for NI-2 configured trunks
- QSIG – Calling name is supported if the standard is similar to NI2
- Inbound calling name is fully supported, but outbound calling name is only supported for Off-System Extension calls

Digital provisioning is provided by the PRI protocol and D-channel signaling. The ShoreGear-T1 supports PRI using DMS-100, 4ESS, 5ESS, and NI-2 signaling types. The ShoreGear-T1 supports ESF or D4 framing formats and B8ZS or AMI line coding.

NOTE The NFAS and Call-by-Call features are not supported.

PRI Trunks

T1 PRI trunks are supported on the ShoreGear-T1 voice switch. They are flexible trunks that support both inbound and outbound calls.

PRI trunks support:

- Inbound calls
- Outbound calls
- DID
- DNIS

- Caller ID number
- Caller ID name is supported for NI-2 configured trunks
- QSIG – Calling name is supported if the standard is similar to NI2
- Inbound calling name is fully supported, but outbound calling name is only supported for Off-System Extension calls

Digital provisioning is provided by the PRI protocol and D-channel signaling. The ShoreGear-T1 supports PRI using DMS-100, 4ESS, 5ESS, and NI-2 signaling types. The ShoreGear-T1 supports ESF or D4 framing formats and B8ZS or AMI line coding.

NOTE The NFAS and Call-by-Call features are not supported.

E1 PRI Trunks

E1 PRI trunks are supported on the ShoreGear-E1 voice switch. They are flexible trunks that support both inbound and outbound calls for international locations.

E1 PRI trunks support:

- Inbound calls
- Outbound calls
- DID
- DNIS
- Caller ID number
- Caller ID name is supported for NI-2 configured trunks
- QSIG – Calling name is supported if the standard is similar to NI2
- Inbound calling name is fully supported, but outbound calling name is only supported for Off-System Extension calls

The ShoreGear-E1 supports PRI signaling using Euro-ISDN as well as other international protocols. See Appendix A, “International Planning and Installation,” for more information.

SIP Trunks

SIP trunks are supported on the ShoreGear-120/24, ShoreGear 90, ShoreGear-60/12, ShoreGear 50, and ShoreGear-40/8 voice switches. They are flexible trunks that support both inbound and outbound calls. SIP trunks are logical trunk end points that only handle SIP call control. Media flows directly between the call initiator and the call terminator.

SIP trunks support:

- Inbound calls
- Outbound calls
- Extension, Tandem, and default destinations for inbound calls
- Caller ID name
- Caller ID number
- DID
- DNIS

By default, the “Enable SIP Info for G711 DTMF signaling” check box is off. This check box must be enabled for ShoreTel-to-ShoreTel SIP tie trunks or for SIP devices that do not support RFC 2833 for G711.

Understanding Trunk Features

The ShoreTel 7.5 system supports several different trunk types and trunk features. It is very important to understand the features available on these trunks, since some services are mutually exclusive. Table 5-2 shows each trunk type and the associated features.

Table 5-2 Trunk Features

Feature	Analog Loop-Start (N.Am.)	Analog Loop-Start (EMEA)	Digital Loop-Start	Analog Wink-Start	Digital Wink-Start	T1 PRI	E1 PRI	SIP	BRI
Inbound:									
• Caller ID Number	Yes	No	Yes	Yes ^a	Yes ^a	Yes	Yes	Yes	Yes
• Caller ID Name	Yes	No	Yes	No	No	Yes ^b	Yes	Yes	Yes
• Direct Inward Dial (DID)	No	No	No	Yes	Yes	Yes	Yes	Yes	Yes
• Dialed Number Identification Service (DNIS)	No	No	No	Yes	Yes	Yes	Yes	Yes	Yes
Outbound:									
• Caller ID Blocked	Yes (CO)	Yes (CO)	Yes (CO)	N/A	Yes (CO)	Yes	Yes	Yes	Yes
• Caller ID Unblocked	Yes (CO)	Yes (CO)	Yes (CO)	N/A	Yes (CO)	Yes	Yes	Yes	Yes
• Caller ID Blocking Override (*67, *82)	Yes ^c	No	Yes ^c	N/A	No	Yes	No	No	No

a. Via Automatic Number Identification (ANI).

b. Caller ID Name is supported for NI-2 configured trunks.

c. *67 and *82 codes do not work if the CO requires a pause between the code and the dialed number.

Legend to Table 5-2

- Yes—Feature is supported.
- No—Feature is not supported.
- Yes (CO)—Feature is provided by the central office (CO) or legacy PBX.
- N/A—Outbound calls are not supported on analog wink-start trunks.

Caller ID Number

Caller ID Number delivers to the ShoreTel 7.5 system the number of the calling party, which is displayed in the ShoreWare Call Manager as well as on Caller ID-compatible telephones. The delivery of the caller ID number can be blocked by the calling party. The caller ID number is delivered unless the calling party has blocked the call (in which case the call is marked as “Blocked”), or the service provider does not have the information (in which case the call is marked as “Unavailable”).

Caller ID Number has the following limitations:

- The calling party may block his or her caller ID number.

- The calling party may be calling from a business and the calling number may be incorrect.
- The calling party may be calling from someone else's number.

Caller ID Number is available on analog loop-start, digital loop-start, SIP, T1 PRI, and E1 PRI trunks.

Two different Caller ID Number formats are used to deliver caller information via loop-start trunks: Single Data Message Format (SDMF) and Multiple Data Message Format (MDMF). SDMF provides the calling number, while MDMF provides any combination of calling name and number. The ShoreGear voice switches support both SMDF and MDMF dynamically, without the need for configuration. When PRI is used, the caller ID number is delivered as a D-Channel message.

ShoreTel 7.5 supports International Caller ID, ensuring that when a switch is configured for a certain site (e.g. Spain), the International ID information is automatically filled in as appropriate for that country. The feature is transparent from the user's standpoint, and no configuration is necessary.

Caller ID Name

Caller ID Name delivers the name of the calling party to the ShoreTel 7.5 system. The name is displayed in the ShoreWare Call Manager as well as on any telephones that support caller ID Name.

By default, the caller ID name is delivered unless the calling party has blocked the transfer of this information (in which case the call is marked as “Blocked”). If the service provider does not have the information, the call is marked as “Unavailable.”

Caller ID Name is available on analog loop-start and digital loop-start trunks, as well as SIP, T1 PRI, and E1 PRI trunks and is only supported on IP phone and analog phones in North America. This feature is not supported on analog phones in other countries.

When using NI-2 signaling on PRI trunks—for example in a tie-trunk scenario—Caller-ID Name is now also captured when available on all inbound calls. For outbound calls, Caller-ID Name is delivered for calls that are made to off-system extensions, but not for outbound calls.

Automatic Number Identification (ANI)

Automatic Number Identification (ANI) delivers the number of the calling party to the ShoreTel 7.5 system. Although similar to Caller ID Number, ANI is tariffed differently and is not subject to the same blocking restrictions as Caller ID Number. For instance, when you purchase ANI services from your service provider, you are always delivered the calling number for 800-number calls (calls that you are paying for). This may vary from region to region.

ANI is available on analog wink-start and digital wink-start trunks.

When ANI is being used, the star key (*) must be used to delimit the ANI digits from the DID/DNIS digits—that is, *<ANI>*<DID/DNIS>*.

Direct Inward Dial (DID)

Direct Inward Dial (DID) allows extensions (users, menus, workgroups, route points, etc.) on the system to be accessed directly, without the need of an auto-attendant or operator. This is particularly useful when users on the system want their own telephone number.

DID is available on analog wink-start, digital wink-start, PRI and SIP trunks.

DID numbers are ordered in blocks of 20 or more 10-digit telephone numbers. These numbers are assigned to a customer and are routed to a wink-start, PRI or SIP trunk connected to a voice switch. When a call is made, the service provider sends a predefined set of digits (from 3 to 10 digits) via the wink-start, PRI, or SIP trunk. The voice switches capture the digits and route the calling party to the called party.

If ANI is not being used on wink-start trunks, only the DNIS digits need to be delivered. If ANI is being used, the star (*) key must be used to delimit the ANI digits from the DID/DNIS digits—that is:

- <DID>
- <DNIS>
- *<ANI>*<DID/DNIS>*

Dialed Number Identification Service (DNIS)

Dialed Number Identification Service (DNIS) allows extensions (users, menus, workgroups, route points, etc.) on the system to be accessed directly, without the need of an auto-attendant or operator. This is particularly useful for workgroup and other call center applications. The DNIS information is delivered to the ShoreTel Personal Call Manager and stored in the call detail record.

DNIS is available on analog wink-start, digital wink-start, PRI and SIP trunks.

DNIS numbers are ordered individually and map to a dialed number. When a calling party dials a specific telephone number, the service provider routes the call to a wink-start or PRI trunk connected to a voice switch. The service provider sends a predefined set of digits (from 3 to 10 digits)—the DNIS digits—using DTMF signaling (or a D-Channel message or SIP message). The voice switches capture the digits and route the calling party to the called party.

If ANI is not being used on wink-start trunks, only the DNIS digits need to be delivered. If ANI is being used, the star (*) key must be used to delimit the ANI digits from the DID/DNIS digits—that is:

- <DID>
- <DNIS>
- *<ANI>*<DID/DNIS>*

Outbound Caller ID

The ShoreTel 7.5 system sends the user's DID number as the caller ID number for outbound calls over PRI or SIP trunks. If the DID number is unavailable, the site Caller Emergency Service ID (CESID) is used. If that number is unavailable, no caller ID appears for outbound calls.

Additionally, the outbound caller ID can be configured on a per-user basis such that the configured value can take precedence over the user's DID number or the site CESID. Note that this feature is only available on outbound calls using a T1 PRI trunk.

- To send a single main number rather than a user's DID number, simply assign DNIS entries rather than DID numbers to each user, and the Site Contact Number will be sent instead.
- To block all outbound caller ID numbers from being sent, you can configure the PRI trunk group to always block the caller ID number.
- On wink-start and loop-start trunks, the outbound caller ID is defined by the service provider.
- On T1 PRI and loop-start trunks, users can override the Caller ID Blocking configuration on a call-by-call basis by using commands at the telephone (*67, *82). Users cannot override the Caller ID Blocking configuration of wink-start and E1 PRI trunks.

For more information on configuring outbound caller ID, please refer to the *ShoreTel 7.5 Administration Guide*.

Tandem Trunking

Tandem trunking allows legacy voice systems to utilize a ShoreTel system for outbound dialing. The ShoreTel system supports both user-side and network-side PRI, allowing ShoreTel 7.5 systems to flexibly support digital tie trunks to other systems.

You can enable tandem trunking support for any PRI trunk group with a simple check box in ShoreWare Director. Tandem calls are associated with a user group for outbound trunk selection. Inbound calls recognized as tandem calls are redirected to an outbound trunk based on the user group call permissions and trunk group access. When needed, a "dial-in prefix" can be specified that is prepended to digits collected on tandem calls. The concatenated set of digits is then used in outbound trunk selection for the tandem call.

Tie Trunks

The addition of network-side PRI support makes PRI tie trunks easier and more compelling to deploy. ShoreGear-T1 switches can now act as either the user-side or network-side of a PRI tie trunk. The tie trunk may be used to tie a ShoreTel system to a legacy voice system, or potentially to another independent ShoreTel system.

Performing Traffic Calculations

The number of trunks required on your system will vary depending on the number of users and your specific application needs. It is important to order your trunking correctly; too few can lead to blocked calls when all trunks are busy, and too many trunks can lead to wasted money on monthly access charges.

See Chapter 3, “Planning and System Design,” for information about calculating the trunk requirements for your site.

Ordering Telephone Service

Once you have determined the types of trunks you need, you will have to either place a new order or make a change order. You can use the associated “Telephone Service Order Forms” that are available on the ShoreWare DVD or on the ShoreTel support web site. Three order forms are provided for your use:

- Analog Service
- T1 Service
- T1 PRI Service

NOTE ShoreTel does not provide an E1 PRI form because this service varies by country. Instead, we provide a table of the E1 PRI parameters that must be set. See Appendix A, “International Planning and Installation,” for more information.

When the form is completed, arrange a meeting with your telephone company service representative to order the new telephone services. The forms contain specific information that the service representative must have before services can be ordered.

Before ordering your telephone service, pay special attention to the installation date and time, as follows:

- If you are **ordering new service**, it should be installed one week before the planned cut-over date. This allows the services to be terminated on the ShoreTel 7.5 system and tested before cut-over.
- If you are **changing existing service**, any changes before the cut-over date might render your existing service unusable. You must schedule these changes outside normal business hours and work closely with your service provider for a seamless transition.

When ordering DID service, the last digits of the DID numbers should match your extension numbers for ease of use. You must make sure your extension numbers do not begin with a trunk access code, zero, or any emergency numbers such as 911 in North America.

Please see the appendix on emergency 911 operations in the *ShoreTel 7.5 Administration Guide* for information on how to configure your system for emergency calls.

Analog Service

Use the Analog Telephone Service Order form (Figure 5-1) to order analog trunks. Note the following about analog service:

- Caller ID Name and Number are supported on loop-start trunks.
- ANI is supported on wink-start trunks.
- ANI on wink-start trunks must be delivered as * <ANI> * <DNIS> *.

Telephone Service Order - Analog Trunks	
Customer Name:	<input type="text"/>
Today's Date:	<input type="text"/>
Cut-over Date:	<input type="text"/>
Cut-over Time:	<input type="text"/>
Vendor	
Make:	ShoreTel, Inc.
Model:	ShoreGear
FCC Registration Number:	4ABUSA-26003-MF-E
Ringer Equivalence:	0.5B
Analog Loop Start Trunks	
Quantity of Trunks:	<input type="text"/>
Protocol:	Loop Start
Signalling:	DMTF
Caller ID:	Yes / No <input type="text"/>
Caller ID Format:	MDMF
Caller ID Delivery:	Blocked / Unblocked <input type="text"/>
Analog Wink Trunks	
Quantity of Trunks:	<input type="text"/>
Protocol:	Wink Start
Signalling:	DTMF
Automatic Number Identification (ANI):	Yes / No <input type="text"/>
Direct Inward Dial (DID):	Yes / No <input type="text"/>
Quantity of Numbers (Block):	<input type="text"/>
Number of Digits:	3 - 4 - 5 - 6 - 7 - 8 - 9 - 10 Example: 100, 200
Dialed Number Identification Service (DNIS):	Yes / No <input type="text"/>
Quantity of Numbers:	<input type="text"/>
Number of Digits:	3 - 4 - 5 - 6 - 7 - 8 - 9 - 10
Comments	
<input type="text"/>	

Figure 5-1 Telephone Service Order Form—Analog Trunks

T1 Service

Use the T1 Telephone Service Order form (Figure 5-2) to order T1 trunks. Note the following about T1 service:

- Caller ID Name and Number are supported on loop-start trunks.
- ANI is supported on wink-start trunks.
- ANI on wink-start trunks must be delivered as *<ANI>*<DNIS>*.
- A channel service unit (CSU) is built into the ShoreGear-T1 voice switch.

Telephone Service Order - T1 Trunks	
Customer Name:	
Today's Date:	
Cut-over Date:	
Cut-over Time:	
Vendor	
Make:	ShoreTel, Inc.
Model:	ShoreGear
FCC Registration Number:	4ABUSA-26003-MF-E
Ringer Equivalence:	0.5B
Digital Loop Start Trunks	
Quantity of Trunks:	
Protocol:	Loop Start
Signalling:	DTMF
Framing Format:	ESF / D4
Line Code:	B8ZS / AMI
Caller ID:	Yes / No
Caller ID Format:	MDMF
Caller ID Delivery:	Blocked / Unblocked
Digital Wink Trunks	
Quantity of Trunks:	
Protocol:	Wink Start
Signalling:	DTMF
Framing Format:	ESF / D4
Line Code:	B8ZS / AMI
Automatic Number Identification (ANI):	Yes / No
Direct Inward Dial (DID):	Yes / No
Quantity of Numbers (Block)	
Number of Digits:	3 - 4 - 5 - 6 - 7 - 8 - 9 - 10
Dialed Number Identification Service (DNIS):	Yes / No
Quantity of Numbers:	
Number of Digits:	3 - 4 - 5 - 6 - 7 - 8 - 9 - 10
Example: 100, 200	
Comments	

Figure 5-2 Telephone Service Order Form—T1 Trunks

T1 PRI Service

Use the T1 PRI Telephone Service Order form (Figure 5-3) to order T1 PRI trunks. Note the following about T1 PRI service:

- Caller ID Number is supported on T1 PRI trunks. (Caller ID Name is supported in NI-2 configured trunks.)
- A channel service unit (CSU) is built into the ShoreGear-T1 voice switch.

Telephone Service Order - PRI Trunks	
Customer Name:	
Today's Date:	
Cut-over Date:	
Cut-over Time:	
Vendor	
Make:	ShoreTel, Inc.
Model:	ShoreGear
FCC Registration Number:	4ABUSA-26003-MF-E
Ringer Equivalence:	0.5B
PRI Trunks	
Quantity of Trunks:	
Protocol:	PRI
Central Office Type:	4ESS / 5ESS / DMS-100 / NI-2
Signalling:	DTMF
Framing Format:	ESF / D4
Line Code:	B8ZS / AMI
Service:	Inbound / Outbound / Both
Caller ID:	Yes / No
Caller ID Delivery:	Blocked / Unblocked
Direct Inward Dial (DID):	Yes / No
Quantity of Numbers (Block):	
Number of Digits:	3 - 4 - 5 - 6 - 7 - 8 - 9 - 10
Dialed Number Identification Service (DNIS):	Yes / No
Quantity of Numbers:	
Number of Digits:	3 - 4 - 5 - 6 - 7 - 8 - 9 - 10
Example: 100, 200	
Comments	

Figure 5-3 Telephone Server Order Form—PRI Trunks

Ordering Service

When you order service, be sure to do the following:

- State that a new ShoreTel 7.5 system is being installed.
- State the date and time the new telephone service must be cut over.
- Review all the items on the telephone service order form with the service representative.
- Review any existing and new telephone numbers and have the telephone company representative confirm the order.

E1 PRI Service

See Appendix A, “International Planning and Installation,” for more information about ordering E1 PRI service.

C H A P T E R 6

Dialing Plan

This chapter provides an overview of the dialing, call routing, and digit-manipulation capabilities of the ShoreTel 7.5 system.

The information in this chapter is particularly useful for administrators of larger, multisite installations.

Overview

When a phone number is dialed in a ShoreTel 7.5 system, the system performs two distinct operations on a telephone number:

Digit collection. Voice switches collect the digits in a telephone number.

Digit manipulation. The switches manipulate the dialed numbers before outputting them to the service provider.

In this chapter you will learn how to define what happens at each of these steps. Once you are familiar with these concepts, we will introduce you to On-Net Dialing, a feature that allows users to divide phone numbers into two separately-managed parts for a more flexible dialing plan.

Checklist

Before configuring your phones (but **after** mapping out your network and trunk configuration), you need to perform the tasks in the table below:

Task Description	See
<input type="checkbox"/> Define Digit Collection	page 6-2
<input type="checkbox"/> Define Digit Manipulation	page 6-10
<input type="checkbox"/> On-Net Dialing	page 6-11

Define Digit Collection

When someone picks up a telephone in a ShoreTel 7.5 system and begins dialing a telephone number, the voice switch software examines each digit in the number and determines whether digit collection should continue or be terminated.

Configuring Internal Numbers

In a ShoreTel 7.5 system where users dial internal numbers without an access code, the rules for digit collection are relatively straightforward.

Digit collection rules are configured through ShoreWare Director. To view the **Dialing Plan** edit page, click **Dialing Plan** under **System Parameters**. Figure 6-1 shows the **Dialing Plan** edit page.

The screenshot displays the 'System Parameters - Edit Dialing Plan' interface. On the left is a navigation tree under 'ShoreWare Director' with 'System Parameters' > 'Dialing Plan' selected. The main content area includes:

- System Parameters** header with 'Save' and 'Reset' buttons.
- Edit this record** and [Refresh this page](#) links.
- Number of Extension Digits:** 4, with a link [Increase Extension Length](#).
- Dialing Plan:** A table for digit collection rules:

Digit:	Reservation:
0:	Operator
1:	Extensions
2:	Extensions
3:	Extensions
4:	Extensions
5:	Extensions
6:	Extensions
7:	Extensions
8:	Extensions
9:	Trunk Access Codes (1 Digit)
#:	Voice Mail Login
*:	Feature Activation
- First System Distribution List:** 4600
- Last System Distribution List:** 4699
- First Menu Number:** 4700
- Last Menu Number:** 4799

Figure 6-1 Dialing Plan Edit Page

Planning Your Dialing Configuration

When setting up a dialing plan for internal numbers, you need to consider the following:

- **Choose an extension length.** ShoreTel supports 3-, 4-, and 5-digit dialing for internal numbers (4-digit dialing works for most enterprises). Use an extension number scheme that conforms to your company's size and the convenience of your users.
- **Map extension ranges.** After choosing the extension length, you can allocate blocks of numbers for use by extension, starting with the first number.

For example, if you want to reserve the range of numbers 3000-3999 for extension assignment, you allocate the “3” number block for extensions.

For maximum usability, map extension numbers to the final digits of your DID (if DID is used).

NOTE Extensions cannot begin with “911” (911, 911x, or 911xx).

Digit Collection Rules

When routing calls, the ShoreTel 7.5 system follows the digit collection rules specified on the **Dialing Plan** edit page in ShoreWare Director.

For the first digit collected, specific rules are in effect.

Digit	Rule
0 ^a	Digit collection is stopped and the call is routed to the site operator.
#	Digit collection is stopped and the call is routed to voice mail login.
Any other digit	<p>Digit collection continues until a complete extension number is dialed. If the number is valid, the call is routed to the extension.</p> <ul style="list-style-type: none"> • If the extension is a valid off-system extension, the call is routed to a trunk. • If the extension is invalid, the call is routed to the Backup Automated Attendant. <p>Note Rule does not apply to trunk access codes.</p>

a. The digit configured in the dialing plan as the operator digit.

Exception for 911 Emergency Calls

Emergency calls do not require an access code.

The following rules apply only to 911¹ calls:

- If “911” is dialed, the switch routes the call to a 911-capable trunk group associated with the caller’s User Group.
- Before switching the emergency call, the switch invokes a brief timeout for insurance against accidental 911 calls. If any digit is entered during the timeout, the switch routes the call to the Backup Automated Attendant.

Please see the appendix on emergency 911 operations in the *ShoreTel 7.5 Administration Guide* for information on how to configure your system for emergency calls.

To define digit collection for internal numbers:

- In ShoreWare Director, go to the **Dialing Plan** edit page under **System Parameters** and edit the dialing plan parameters. See the *ShoreTel 7.5 Administration Guide* for a description of the parameters on this page.

Changing Extension Length

The ShoreTel 7.5 system supports 3-, 4-, and 5-digit extensions.

1. Although this section focuses on emergency calls made within the United States, the same rules apply in other countries.

To change the extension length:

Step 1 Click **Increase Extension Length**.

Step 2 Specify 4 or 5 digits for the increased length.

NOTE After applying your edits, you cannot decrease an extension length. For example, once it is increased to 4, the minimum is 4.

NOTE If your system uses three-digit extensions, ShoreTel recommends that you do not assign x11 extensions to users.

Configuring External Numbers

The ShoreTel 7.5 system supports 1-, 2-, and 3-digit trunk access codes. When an access code is dialed, the system looks for a valid digit in the parameters.

If an invalid number is dialed, the system plays a recording to the calling party.

There are several types of valid telephone numbers, which are described in the following sections.

The ShoreTel 7.5 system allows the system administrator to provide users at each site with a unique dialing plan to match the dialing plan of the site's geographic region. The ShoreTel 7.5 system supports 7-digit local dialing, 10-digit local dialing, and mixed local dialing.

External numbers are converted into a standard “canonical format” by call control software to provide a globally consistent way of handling phone numbers. The canonical format starts with a “+” representing the international prefix, followed by the country code, area code, and subscriber number.

- External numbers that can be converted into canonical format are considered “routable” and will leverage the network call routing feature of the call control software.
- External numbers that are unique to the country (n11, 112, 911, and so on) are considered “unroutable” and will not leverage the network call routing software. These calls will be placed from the local site or the associated proxy site.

Configuring 7-Digit Local Dialing

The **Local Area Code** on the **Site** edit page, shown in Figure 6-2, defines 7-digit dialing for all users at the site. When a user dials an access code followed by 7 digits, the switching software assumes the site local area has been dialed. The switching software then converts the 7-digit number into canonical format before checking call permissions and doing network call routing.

Figure 6-2 Site Edit Page

NOTE The **Local Area Code** and **Additional Local Area Codes** set on the **Site** edit page have nothing to do with the **Local Area Code**, **Additional Local Area Codes**, and **Nearby Area Codes** on the **Trunk Group** edit page. Area codes on the **Site** edit page relate only to digit collection, whereas those on the **Trunk Group** edit page relate only to Network Call Routing and Digit Manipulation.

To define 7-digit dialing:

Step 1 Open the **Site** edit page in ShoreWare Director.

Step 2 Enter the 3-digit area code in the **Local Area Code** field.

See the *ShoreTel 7.5 Administration Guide* for more information about the **Site** edit page.

Configuring 10-Digit Local Dialing

If the site is in a location with overlay area codes, it can be configured to support 10-digit dialing for all the local area codes. The **Additional Local Area Codes** field on the **Site** edit page defines the area codes for 10-digit dialing. When a user dials an access code followed by a local area code, the system collects 7 additional digits (10 digits total) before stopping digit collection. The switching software then converts the 10-digit number into canonical format before checking call permissions and doing network call routing.

To define 10-digit dialing:

- Step 1** Open the Site edit page in ShoreWare Director.
- Step 2** Click **Edit** next to the **Additional Local Area Codes** field.

The **Additional Local Area Codes** dialog box, shown in Figure 6-3, appears.



Figure 6-3 Additional Local Area Codes Dialog Box

See the *ShoreTel 7.5 Administration Guide* for more information about the **Additional Local Area Codes** field on the Site edit page.

Configuring Mixed Dialing in the Same Area

In locations where users are forced to dial 7 digits for some prefixes and 1+10 digits for other prefixes in the same area, the ShoreTel 7.5 system supports permissive dialing—that is, you can dial these numbers either as 7 digits or as 1+10 digits. It also supports permissive dialing in locations with mixed 10-digit and 1+10 digit dialing in the same area.

NOTE From a digit-manipulation (or outpulsing) point of view, the trunk group must be configured properly since some service providers do not support permissive dialing. See “Define Digit Manipulation” on page 6-10.

1+10 Digit Long-Distance Dialing

The ShoreTel 7.5 system supports long-distance dialing. When a user dials an access code followed by “1,” the software collects 10 additional digits before stopping digit collection.

International Dialing

The ShoreTel 7.5 system supports international dialing. If the user dials a trunk access code followed by an international access code, digit collection is terminated after a timeout. The timeout can be bypassed by dialing pound (#).

n11 Dialing

The ShoreTel 7.5 system supports “n11” dialing, including 411 (information) and 611 (support). If the user dials an access code followed by “n11,” digit collection is terminated after a brief timeout and the call is routed to a trunk.

NOTE If your system uses three-digit extensions, ShoreTel recommends that you do not assign x11 extensions to users.

911 Dialing

The ShoreTel 7.5 system supports 911 dialing to emergency services. If the user dials an access code followed by “911,” digit collection is terminated immediately and the call is routed to a trunk.

NOTE 911 calls are routed out of the local site’s associated trunks. If there are no 911 trunks available at the local site, the call is routed via the designated proxy site.

Please see the appendix on emergency 911 operations in the *ShoreTel 7.5 Administration Guide* for information on how to configure your system for emergency calls.

WARNING Do not place 911 calls from any SIP devices. ShoreTel supports SIP trunks but does not support SIP extensions.

Explicit Carrier Selection (101xxxx) Dialing

The ShoreTel 7.5 system supports explicit carrier selection. If the user dials an access code followed by “101,” the next four digits collected are for explicit carrier selection (101xxxx). The carrier information is retained and passed to the trunk. The digits collected are treated as unroutable calls; the digits are routed “as-is” out either local site or proxy site trunks only.

Operator-Assisted (0, 00) Dialing

The ShoreTel 7.5 system supports operator-assisted dialing. If the user dials an access code followed by “0x,” digit collection is terminated after a brief timeout and the call is routed to a trunk.

Vertical Service Code (*67, *82) Dialing

The ShoreTel 7.5 system supports some vertical service codes for feature activation. If the user dials an access code followed by star (*), subsequent digits are collected and terminated by a brief timeout. The digits collected are treated as unroutable calls—they will be routed “as-is” out either local site or proxy site trunks only. If the trunk used is a PRI trunk, that trunk strips and interprets *67 to block outbound Caller ID, and *82 to unblock outbound Caller ID.

End Digit Collection (#)

In some cases, digit collection ends after a timeout period. To bypass the timeout and route the call immediately, dial pound (#).

Dialing from the ShoreWare Call Manager

When you dial an external number from the ShoreWare Call Manager application, the number is converted into canonical format, prepended with an access code, and passed first to the ShoreWare server and then to the ShoreGear voice switch.

- If a 7-digit number is dialed, the user's site local area code is added to the dialed number.
- The user's Default Trunk Access Code, found in the ShoreTel Control Panel, is added to the external number.

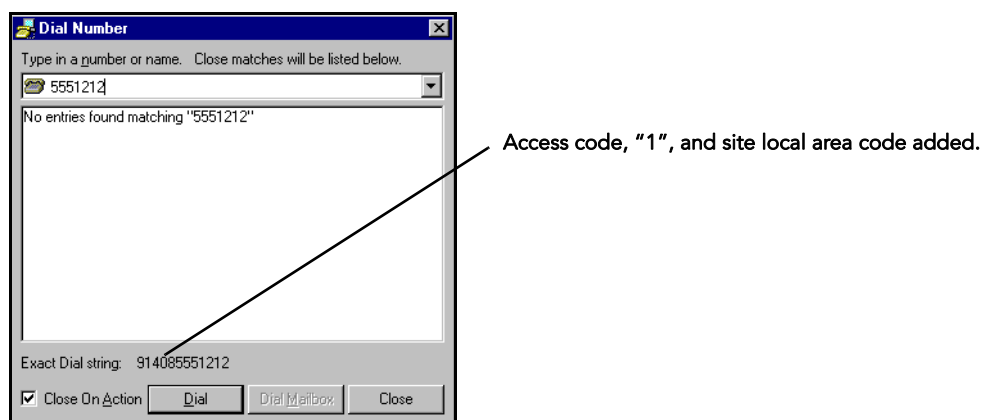
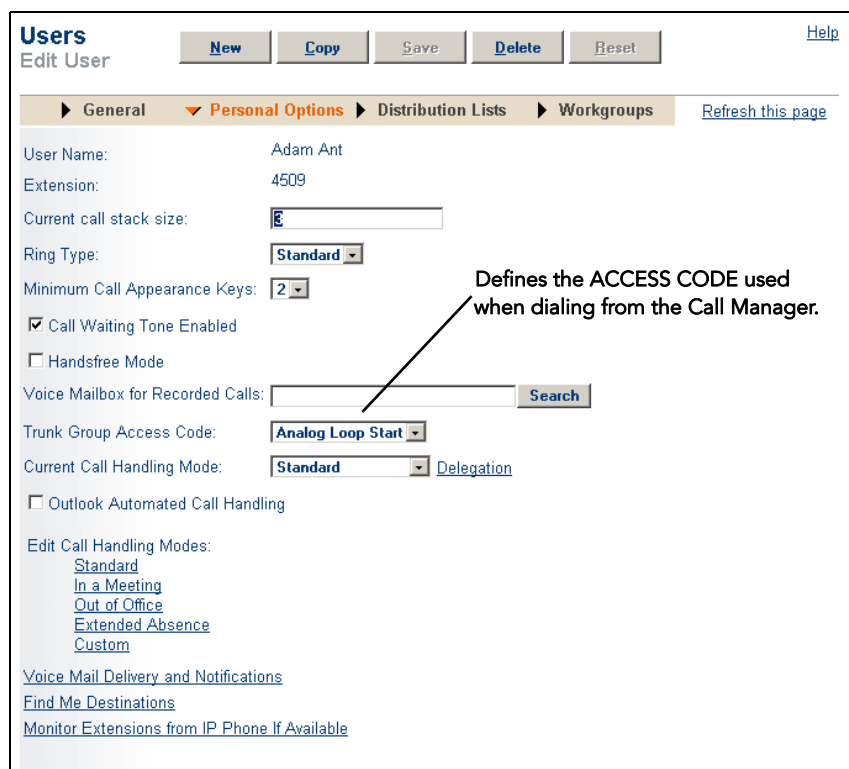

Figure 6-4 Dialing from the ShoreWare Call Manager

The **Trunk Group Access Code** setting in ShoreWare Director is used only to determine the *access code* passed by the ShoreWare Call Manager to the ShoreWare server. It *does not* dictate the actual trunk group that will be selected by default.



Users [New](#) [Copy](#) [Save](#) [Delete](#) [Reset](#) [Help](#)

[Edit User](#)

[General](#)
[Personal Options](#)
[Distribution Lists](#)
[Workgroups](#)
[Refresh this page](#)

User Name: Adam Ant
 Extension: 4509
 Current call stack size:
 Ring Type: [Standard](#)
 Minimum Call Appearance Keys: [2](#)
 Call Waiting Tone Enabled
 Handsfree Mode
 Voice Mailbox for Recorded Calls: [Search](#)
 Trunk Group Access Code: [Analog Loop Start](#)
 Current Call Handling Mode: [Standard](#) [Delegation](#)
 Outlook Automated Call Handling

Edit Call Handling Modes:
[Standard](#)
[In a Meeting](#)
[Out of Office](#)
[Extended Absence](#)
[Custom](#)

[Voice Mail Delivery and Notifications](#)
[Find Me Destinations](#)
[Monitor Extensions from IP Phone If Available](#)

Defines the ACCESS CODE used when dialing from the Call Manager.

Figure 6-5 Trunk Group Access Code Setting (User Edit Page Detail)

Define Digit Manipulation

Once the route decision has been made, the call is passed to the trunk. The dialed number, which is normally passed within the system in canonical format, is examined and manipulated based on the trunk group configuration. This ensures that the number can be properly received by the service provider.

First, the trunk access code dialed by the user is removed. If the number is in canonical format (local, long distance, ERC, international), digit manipulation can occur. If the number is unroutable (n11, ECS, operator, and vertical service code numbers) digit manipulation (other than the dial-out prefix) is not applied.

Trunk Digit Manipulation:

Remove leading 1 from 1+10D
Hint: Required for some long distance service providers.

Remove leading 1 for Local Area Codes (for all prefixes unless a specific local prefix list is provided below)
Hint: Required for some local service providers with overlay area codes.

Dial 7 digits for Local Area Code (for all prefixes unless a specific local prefix list is provided below)
Hint: Local prefixes required for some local service providers with mixed 7D and 1+10D in the same home area.

Local Prefixes: [Go to Local Prefixes List](#)

Prepend this Dial Out Prefix:

Off System Extensions:

Figure 6-6 Digit Manipulation on the Trunk Group Edit Page

To specify trunk digit manipulation:

Step 1 Open the **Trunk Digit Manipulation** page, shown in Figure 6-6.

Step 2 Select the options and specify numbers as needed, using Table 6-1 as a guide.

Table 6-1 Digit Manipulation Options

Option	Description	Example
Remove leading 1 from 1+10D	This option is required by some long-distance service providers that only accept numbers dialed as 10 digits.	AT&T typically only supports 10-digit dialing.
Remove leading 1 for Local Area Codes	This option is required by some local service providers that have <i>mixed 10-digit and 1+10 digit dialing in the same area code</i> . Local Area Codes include both the Local Area Code and Additional Local Area Codes configured against the trunk group.	Atlanta has three local area codes that must be dialed as 10 digits. Note This could also be called “Dial 10 digits for Local Area Codes.”
Dial 7 digits for Local Area Code	This option is required by some local service providers that have <i>mixed 10-digit and 1+10 digit dialing in the same area code</i> .	Massachusetts and Maine.
Prepend this Dial Out Prefix	The Dial Out Prefix is prepended to the number. This feature is typically used when connecting the ShoreTel 7.5 system to a legacy PBX system using the ShoreGear-T1 voice switch. The Dial Out Prefix enables the ShoreTel 7.5 system to seize a trunk on the legacy PBX. The Dial Out Prefix is not applied to Off-System Extensions.	Not applicable.

Table 6-1 Digit Manipulation Options

Option	Description	Example
Vertical Service Codes	<p>If a Vertical Service Code was dialed, digit manipulation rules do not apply.</p> <p>Vertical Service Codes work with ISDN PRI trunks and some loop-start trunks.</p> <ul style="list-style-type: none"> • With PRI trunks, Vertical Service Codes for Caller ID Blocking control will be converted to D-Channel messages. • With loop-start trunks, the service provider must be able to accept the outpulsed digits with only 50 msec of pause between each digit, including the service codes. <p>Vertical Service Codes are typically not supported by service providers on wink-start trunks. If you have outbound access on wink-start trunks and you dial a vertical service code, you will likely get an error message from the service provider.</p>	Not applicable.
Off System Extensions	<p>Off System Extensions define ranges of extensions that when dialed will be routed out of this trunk group. This is typically used to interface to a legacy PBX system using the ShoreGear-T1 or ShoreGear-E1 voice switch. Off-system extensions digits can be manipulated using a translation table.</p> <p>Digit manipulation, including the Dial Out Prefix, will not be applied to these calls.</p>	Not applicable.

On-Net Dialing

ShoreTel 7.5 supports On-Net Dialing (OND), an enhancement that allows users to create more flexible dialing plans than before. In contrast with previous releases which could only support a “flat” dialing plan and treated all numbers as a single, indivisible unit, the On-Net Dialing feature allows users to divide phone numbers into two separately-managed parts:

- extension prefix - typically 3 digits in length; similar in concept to a site code
- user extension - typically 4 digits in length; acts as the number you would dial to reach other users in your organization

By dividing phone numbers into two parts, the OND feature provides customers with a more seamless method of migrating from their legacy phone systems to the newer ShoreTel system. OND allows customers to preserve their existing dialing plans when integrating ShoreTel equipment with their legacy equipment. While previous releases allowed customers to integrate ShoreTel equipment with their legacy PBX, the configurations needed to maintain the customer's existing dialing plan were complex and the complexity increased with the number of people and extensions involved.

For example, if one company acquired another company and the two companies wanted to merge their phone systems, then no two users could have the same user extension, even if they were at different sites with different prefixes.

With OND, users will be able to call other users within a site by dialing only the user extension. Inter-site calls would require users to dial the extension prefix plus the user number. Off-system extensions (OSE's) will continue to be used to route calls to legacy PBX's.

How It Works

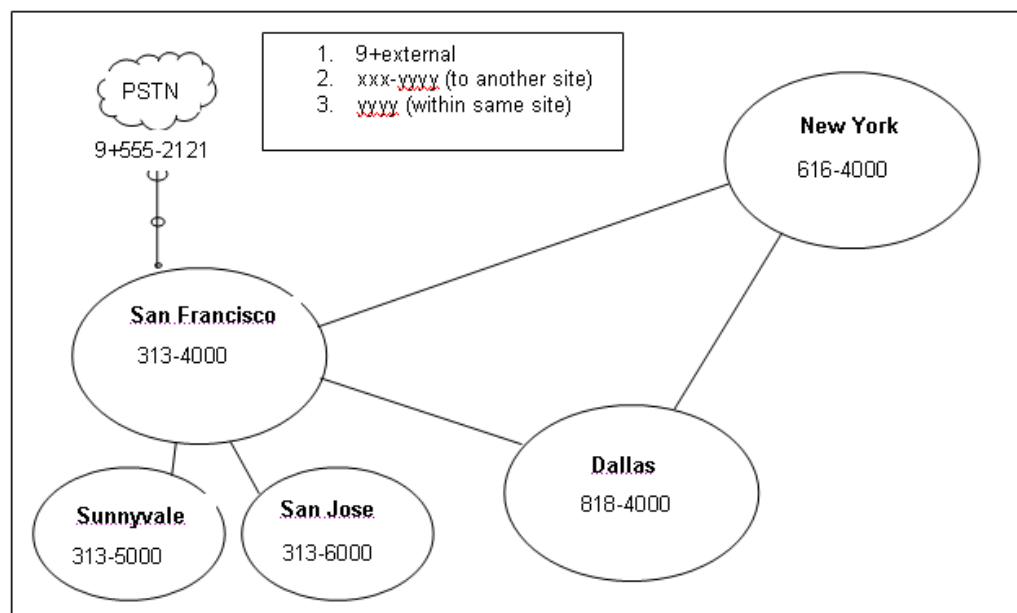

Figure 6-7 Abbreviated 4-digit dialing with extension prefix

As shown in the illustration above, On-Net Dialing assigns extension prefixes to each site or to a group of sites. All calls are placed “on the network” if they are within the same prefix, and the user need only dial the user extension. Calls preceded with the trunk access code (usually “9”) are sent to the PSTN.

Benefits of On-Net Dialing:

- **Scalability** – For larger organizations, On-Net Dialing enables the creation of a common and consistent “cookie cutter” dialing plan that can be replicated throughout an organization that has many offices. For example, a department store might have a phone in each of its different departments with one for clothing, furniture, kitchenware, etc. With On-Net Dialing, a user can assign the extensions of 4000, 5000, 6000, and 7000 to each of these departments. By modifying the 3-digit site code/extension prefix at each location, this approach of assigning 4-digit extensions to departments can be replicated across an entire department store, nationwide, so that a user who knows the extension for the automotive department in one city could travel to another city and would know how to reach the automotive department if he knew the site code.
- **Preserve existing legacy dialing plans** – As mentioned before, you can preserve the existing dialing plans when adding ShoreTel equipment to a deployment with legacy equipment by assigning a new prefix to each new site or to users on the new ShoreTel system.
- **Legacy integration via OSEs (Off-System Extensions)** – Ability to call multiple legacy PBXs from the ShoreTel system.

- Multi-tenant – On-Net Dialing allows a landlord to maintain one phone system at a building that houses two or more businesses or organizations in such a way that neither organization is aware that the infrastructure or trunk lines are being shared. Despite the fact that both organizations are in the same building, you can assign different prefixes to each company and could then hide one organization's phone numbers from the other group so that neither group would see the other via the directory.

Configuration

The process of configuring On-Net Dialing consists of the following tasks:

- Planning and Configuring the Dialing Plan
- Adding Sites
- Associating an Extension Prefix with a Site
- Assigning User Extensions

Each of these tasks is addressed in more detail below.

NOTE Enabling On-Net Dialing is an irreversible process that makes permanent changes to the database. Thus, you should plan carefully before proceeding with any configuration changes.

Planning and Configuring the Dialing Plan

Assigning extension prefixes to a specific digit must be done all at once. Once the dialing plan window (shown below) has been configured and saved, there is no way to make changes to the extension prefix assignments without erasing the database and starting all over. Therefore, we recommend carefully planning and reviewing your dialing plans before configuring the dialing plan window.

To configure the dialing plan via Director, follow the procedure below:

- Step 1** Launch **ShoreWare Director** and enter the user ID and password.
- Step 2** Click on the **Administration** link to expand the list (if it has not already been expanded).
- Step 3** Click on the **System Parameters** link and then the **Dialing Plan** link to display the Edit Dialing Plan window, as shown below:

System Parameters

Edit Dialing Plan

Save

Reset

[Help](#)

Edit this record		Refresh this page
Number of Extension Digits:	4	Increase Extension Length
Dialing Plan:		
Digit:	Reservation:	
0:	Operator	
1:	Extensions	
2:	Extensions	
3:	Extensions	
4:	Extensions	
5:	Extensions	
6:	Extensions	
7:	Extension Prefix (3 Digit)	
8:	Extension Prefix (4 Digit)	
9:	Extension Prefix (5 Digit)	
#:	Extension Prefix (6 Digit)	
*	Extension Prefix (7 Digit)	
:	Extensions	
	Not Used	
	Operator	
	Trunk Access Codes (1 Digit)	
	Trunk Access Codes (2 Digit)	
	Trunk Access Codes (3 Digit)	

Figure 6-8 Configuring dialing plan

- Step 4** Click on the drop-down menu to the right of the desired digit and select the number of digits you would like the extension prefix (i.e. site code) to contain. Extension prefixes can range from 1 to 7 digits in length. The leading digit determines the length of the prefix. Extension prefixes with different leading digits do not have to contain the same number of digits.
- Step 5** Repeat this process for any other extension prefixes, unused extensions, or trunk access codes.
- Step 6** Click Save to store your changes. The **Configure Extension Prefix Warning** window (similar to the one shown below) appears with a list of each of the sites in your system.

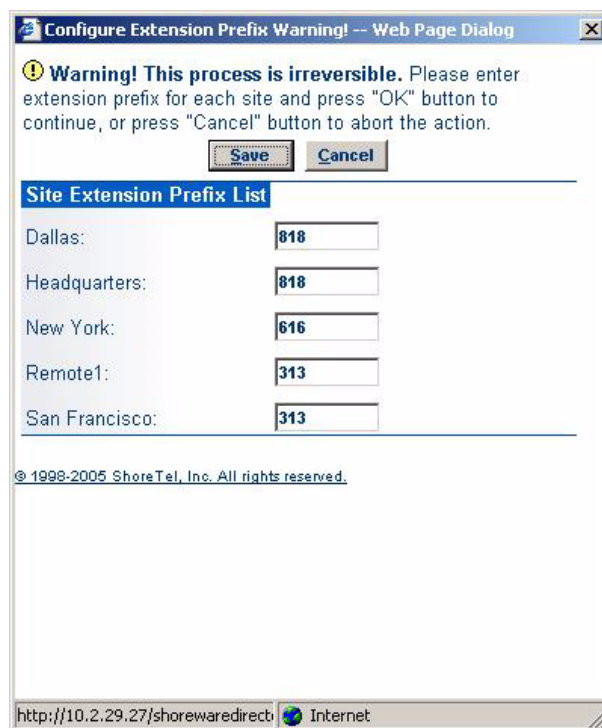

Figure 6-9 Make sure to back up your system before clicking Save

The Extension Prefix Warning message lists each site in your system. Next to the list of sites you will find a blank field that requires you to enter the desired extension prefix. Note that this prefix will be applied to every dialable number at that particular site, so if the site is an existing one, they will see their phone numbers converted to the new prefix.

NOTE System extensions are not associated with a hard port in the system. They are always global and will have a user number and a null extension prefix. Therefore, these system extensions are not affected by changes made to the extension prefix in the Edit Dialing Plan window. Only dialed numbers (user extensions, menus, workgroups, distribution lists) are affected by changes to the extension prefix.

Step 7 Click the Save button to store your changes.

Adding Sites

You can add the sites via ShoreWare Director before configuring your dialing plan (or alternatively, you can configure your dialing plan and then add sites at a later time). To add a site via Director, follow the procedure below:

- Step 1** Launch **ShoreWare Director** and enter the user ID and password.
- Step 2** Click on the **Administration** link to expand the list (if it has not already been expanded).
- Step 3** Click on the **Sites** link.
- Step 4** Click on the **Add a new site in** drop-down menu and select the country where the site will be added.
- Step 5** Click the **Go** link to display a window similar to the one shown below:

Figure 6-10 Add a new site

- Step 6** Enter the name of the site, along with all other relevant information, in the appropriate fields. (Refer to the “ShoreTel Sites” chapter in the *ShoreTel Administration Guide* for additional information on configuring this window.)

NOTE The Extension Prefix field will not appear in this window until after you have modified the Dialing Plan window (which is our next task).

- Step 7** Click **Save** to store your changes.
- Step 8** Repeat this process to add any other sites that you would like to include in the dialing plan.

Once you have created the dialing plan and saved your dialing plan configurations, you can return to the Edit Sites window in Director to verify that the changes have been propagated throughout the system. By clicking on the name of the site, you will see an Extension Prefix field. The field should be populated with the value entered in the Extension Prefix Warning window, as shown in the window below:

The screenshot shows the 'Edit Site' configuration window. At the top, there are buttons for 'New', 'Copy', 'Save', 'Delete', and 'Reset', along with a 'Help' link. Below these is a 'Refresh this page' link and a '* modified' indicator. The main form contains the following fields:

- Name:** New York
- Country:** United States of America
- Language:** English
- Parent:** Remote
- Use Parent As Proxy
- Extension Prefix:** 616 (highlighted with a red circle)
- Local Area Code:** 212
- Additional Local Area Codes:** Edit
- Caller's Emergency Service Identification (CESID):** 1 (212) 616-9191 (e.g. +1 (408) 331-3300)
- Time Zone:** (GMT-05:00) Eastern Time (US & Canada), Eastern Standard Time

Figure 6-11 Extension Prefix field now populated

Adding Users to the System

When the On-Net Dialing feature has been enabled and the extension prefix for a site has been updated, the first new user added to the system may not receive the site's new prefix. (This is due to cookies in the system populating the new user's extension with old and outdated information.) However, after this first user has been added, subsequent users will have their extensions automatically populated with the correct site prefix.

Details:

- User numbers can vary in length from 3 to 5 digits. All user numbers in the system must be the same length.

Quick Reference of Star Codes

Certain features and functions can be performed via the telephone interface through the use of star codes. By pressing the star key (i.e. asterisk) on your phone's keypad, followed by a combination of numbers, you can perform many tasks that would otherwise require the use of a soft key, option button, or programmable button.

Common Star Codes

Park a call	* 1 1 + ext.
UnPark a call	* 1 2 + ext.
Picking Up a Remote Extension	* 1 3 + ext.
Picking Up the Night Bell	* 1 4
Using the Intercom	* 1 5 + ext.
Barge In	* 1 6 + ext.
Silent Monitor	* 1 7 + ext.
Toggling the Hunt Group Status	* 1 8 + HG ext.
Whisper Page	* 1 9 + ext.
Changing Call Handling Mode and Forwarding	Voice Mail + password + # + 7 2
Changing Extension Assignment	Voice Mail + password + # + 7 3 1
Unassign Extension Assignment	Voice Mail + password + # + 7 3 2
Assign Extension to External Number	Voice Mail + password + # + 7 3 3

Office Anywhere Star Codes

Transfer a call	* * + destination + # #
Conference a call	* * + destination + * *
Hold a call	* *
Hang up	# #
Access other "common" star codes	* * + * xx (see table above)+ ext.

Trunk Star Codes

Blocking and Caller ID

* 6 7 + ext.

- When a user places an external call, they can block their Caller ID using the “*67” command. The user dials the trunk access code, followed by *67, followed by the external number.
- When dialing in this manner, the call will be considered “non-routable” and will only access trunks at the local site. The number is dialed “as is” (i.e. as if a user dialed it). No digit manipulation will be performed.

Unblocking Caller ID

* 8 2 + ext.

- When a user places an external call, they can unblock their Caller ID delivering using the “*82” command. The user dials the trunk access code, followed by *82, followed by the external number.
- When dialing in this manner, the call will be considered “non-routable” and will only access trunks at the local site. The number is dialed “as is” (i.e. as if a user dialed it). No digit manipulation will be performed.

Network Call Routing

This chapter provides an overview of call routing, and digit-manipulation capabilities of the ShoreTel 7.5 system. The information in this chapter is particularly useful for administrators of larger, multisite installations.

Overview

When a phone number is dialed in a ShoreTel 7.5 system, the system performs three distinct operations on telephone numbers:

Digit collection. Voice switches collect the digits in a telephone number.

Network call routing. After collecting the digits, the switch checks the number against a user's call permissions, adds trunks to the route list, and makes a final route decision for the call.

Digit manipulation. The switches manipulate the dialed numbers before outputting them to the service provider.

In this chapter you will learn how to plan your network call routing.

Checklist

Before configuring your phones (but **after** mapping out your network and trunk configuration), you need to review the topics in the table below:

Task Description	See
<input type="checkbox"/> Call Permissions	page 7-2
<input type="checkbox"/> Account Codes	page 7-3
<input type="checkbox"/> Trunk Availability	page 7-4
<input type="checkbox"/> Specifying Parameters for the Routing Decision	page 7-5

Define Network Call Routing

Once an external telephone number has been collected, the switching software checks the number against the user's call permissions, finds the list of available trunks, and then makes a routing decision based on several criteria.

Call Permissions

Each dialed number is compared against the user's call permissions. If the call is denied, the calling party will be routed to a “fast busy” intercept tone. If the call is allowed, the routing continues.

The screenshot shows a web interface for editing call permissions. At the top, there's a title 'Class of Service' and a subtitle 'Edit Call Permissions'. To the right are buttons for 'New', 'Copy', 'Save', 'Delete', 'Reset', and 'Help'. Below this is a navigation bar with 'Edit this record' and 'Refresh this page'. The main form has the following fields:

- Name:** A text box containing 'Long Distance Calling'.
- Scope:** A list of radio buttons:
 - Internal Only
 - Local Only
 - National Long Distance
 - National Mobile
 - International Long Distance
 - All Calls
- Restrictions:** A text box with a placeholder '(e.g. +1900,+1xxx976)'.
- Permissions:** A text box with a placeholder '(e.g. 1/311)'.

Figure 7-1 Call Permissions Edit Page

To define call permissions:

- Step 1** Open the Call Permissions edit page (Figure 7-1).
- Step 2** Select the **Scope**. Scope allows you to set a general permission level and is presented from the most restrictive to the most permissive. The Restrictions and Permissions listed are applied *in addition to* the general scope setting for the Class of Service.
 - **Internal Only** allows calls only to internal extensions and to the configured emergency number.
 - **Local Only** allows calls only to local or additional local area codes, as defined on the site edit page. The call permission does not apply to any of the trunk group area codes.
 - **National Long Distance** also allows calls to long-distance numbers within the country, as defined on the Site edit page.
 - **National Mobile** allows calls to mobile phones in countries (e.g. Ireland) with “caller pays” billing plans.
 - **International Long Distance** also allows calls to international numbers, as defined on the Site edit page.
 - **All Calls** allows calls to any number, including 1900, Operator Assisted, and Carrier Select numbers, as well as use of Vertical Service Codes. This is the default.

Step 3 Enter restriction and permission rules. The Restrictions and Permissions listed are applied *in addition to* the general scope setting. The comma separated restriction expressions are limited to a total of 50 characters.

Follow these guidelines for entering restrictions:

- In general, numbers must be entered in canonical format including the international designation “+” and country code. For example, to restrict calls to the 408 area code in the U.S., use +1408. All 7-digit and 10-digit numbers must be entered in canonical format (+Country Code, Area Code, and Subscriber Number).
- Non-routable calls (311, 411, etc.) for a country must be designated by the country code plus the “/” character. For example, to restrict 311 in the U.S., use 1/311.
- Each field can contain multiple entries as long as they are separated by commas or semicolons.
- Each entry must consist of numbers only.
- Access codes, such as 9, must not be included.
- To simplify the entering of call permissions, the wild-card character “x” can be used to represent any number. For instance, to block all calls to 976 prefixes, enter “+1xxx976” as a restriction.

When a call is both restricted and permitted, it is permitted. For example, restricting +1 408 and permitting +1 408 331 restricts all calls to the 408 area code except those to 408 331-xxxx.

Account Codes

If Account Code Collection Service is enabled, when a user dials a number that is outside the scope of his or her call permissions, the call is automatically routed to the Account Code Collection Service extension on the HQ server. The Account Code Collection Service captures call details that can be reviewed in the call detail reports. For more information on these reports, see the *ShoreTel 7.5 Administration Guide*.

The collection of account codes is enabled on a per-user group basis and can be set to be one of three states: **disabled**, **optional**, or **forced**.

The Account Code Collection Service is associated with a configurable extension and has a dedicated user group that defines ultimate call permissions and trunk group access.

When account code collection is enabled or forced for a member of the user group, calls placed via the telephone or the Call Manager are first filtered by call permissions. Calls restricted by call permissions are automatically routed to the extension associated with the Account Code Collection Service. Upon receiving the call, the Account Code Collection Service prompts the user to enter an account code and press the pound (#) key.

If the user enters an account code that does not match the digits in a stored account code, the system plays a message explaining the problem and prompts the user to re-enter the account code. When the user enters an account code that matches one of the stored codes, the code is collected, and the call is completed.

Call Permissions specifies the dialed numbers that are directed to the Account Code Collection Service for any user groups configured for account codes.

Calls redirected to the account codes extension are completed using the trunk access and call permissions associated with the Account Code Collection Service.

The Account Code Collection Service examines outbound calls against two sets of permissions:

- 1 Checks call permissions for the caller's user group to determine if an account code must be collected.
- 2 If user group permissions specify the collection of an account code, a check is performed on the call permissions for the Account Code Collection Service to determine whether call will be permitted or rejected.

If the call is rejected, the intercept tone is played.

The Account Code Collection Service is associated with a system extension hosted on a SoftSwitch that only runs on the headquarters (HQ) server.

If the Headquarters SoftSwitch is unavailable to the ShoreGear switch from which a call originates, the call is handled according to the permissions set for the caller's user group. Calls placed by users who are configured for **optional** account code collection are placed. Calls placed by users who are configured for **forced** account code collection are rejected.

Wildcard characters (represented with a question mark) can be used in place of DTMF digits in the account code. When wildcards are used, a length check is performed instead of a more thorough validation of the code. Although this reduces the stringency of the validation process, it allows the system to support far more than 50,000 account codes – the previous account code limitation.

Refer to the chapter on Call Control in the *ShoreTel 7.5 Administration Guide* for more information about account codes and account code wildcards.

Trunk Availability

For a trunk to be included in the list of possible trunks that can be hunted, the following conditions must apply:

- The trunk must have an access code that matches the access code dialed.
- The trunk must be assigned to the user. (Trunk groups are assigned to user groups.)
- The trunk must be capable of the requested service (Local, Long Distance, International, n11, 911, Easily Recognizable Codes, Explicit Carrier Selection, and Operator Assisted). These services are defined on the **Trunk Group** edit page as shown in Figure 7-2.
- The trunk must be in service.
- The trunk must not already be in use.
- The trunk must be on a switch that the user's switch can reach. (The network is up and running.)
- For multisite calls, the admission control must be met at both sites. Admission control is defined on the **Site** edit page.
- If call is long distance from the trunk, it was not local to the caller. For example, network call routing will not send a local call via a trunk in another state.

Trunk Services:
<input checked="" type="checkbox"/> Local
<input checked="" type="checkbox"/> Long Distance
<input checked="" type="checkbox"/> International
<input checked="" type="checkbox"/> n11 (e.g. 411, 611, except 911 which is specified below)
<input checked="" type="checkbox"/> 911
<input checked="" type="checkbox"/> Easy Recognizable Codes (ERC) (e.g. 800, 888, 900)
<input checked="" type="checkbox"/> Explicit Carrier Selection (e.g. 1010xxx)
<input checked="" type="checkbox"/> Operator Assisted (e.g. 0+)
<input checked="" type="checkbox"/> Caller ID not blocked by default

Figure 7-2 Trunk Services on the Trunk Group Edit Page

To define trunk services:

Step 1 Open the **Trunk Services** dialog box on the **Trunk Group** edit page.

Step 2 Select the services that will be available for the selected trunk.

See the *ShoreTel 7.5 Administration Guide* for more information about the **Trunk Group** edit page.

To define admission control:

Step 1 Open the **Site** edit page.

Step 2 Enter the proper amount in the **Admission Control Bandwidth** field.

See the *ShoreTel 7.5 Administration Guide* for more information about the **Site** edit page and for instructions about computing Admission Control Bandwidth.

Specifying Parameters for the Routing Decision

Once the available set of trunks is established, the switching software makes a routing decision, with the goal of minimizing toll charges and WAN bandwidth. The Network Call Routing algorithm bases the routing decision on the Local Area Code, Additional Local Area Codes, and Nearby Area Codes defined on the **Trunk Group** edit page.

Network Call Routing Algorithm

When multiple trunks meet the same criteria, a trunk is seized randomly. In general, trunks that are configured last are hunted first. Over time, however, as trunks are deleted and added, hunting becomes increasingly random.

NOTE Digital trunks are given precedence over analog trunks in all routing decisions.

To make the routing decision, the algorithm poses the following questions. For the number dialed, is there:

- 1 A trunk at the originating site for which the call is local?

- 2 A trunk at the proxy site for which the call is local?
- 3 A trunk at any other site for which the call is local?

- 4 A trunk at the originating site for which the call is considered nearby?
- 5 A trunk at the proxy site for which the call is considered nearby?
- 6 A trunk at any other site for which the call is considered nearby?

- 7 A trunk at the originating site designated for long distance?
- 8 A trunk at any proxy site designated for long distance?
- 9 A trunk at any other site designated for long distance?

- 10 Any remaining trunk available at originating site?
- 11 Any remaining trunk available at the proxy site?

To specify parameters for the routing decision:

Step 1 Open the **Network Call Routing** page on the **Trunk Group** edit page, shown in Figure 7-3.

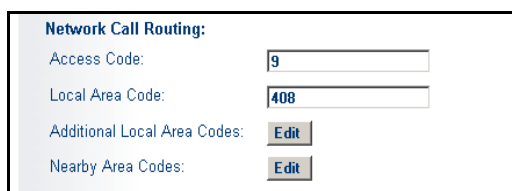

The screenshot shows a configuration panel titled "Network Call Routing:". It contains four rows of input fields and buttons:

- Access Code:** A text input field containing the number "9".
- Local Area Code:** A text input field containing the number "408".
- Additional Local Area Codes:** A text input field followed by a blue "Edit" button.
- Nearby Area Codes:** A text input field followed by a blue "Edit" button.

Figure 7-3 Network Call Routing on the Trunk Group Edit Page

Step 2 Enter values into the **Local Area Code**, **Additional Local Area Codes**, and **Nearby Area Codes** fields.

Step 3 Open the **Trunk Group** edit page and, toward the bottom of the page, click **Go to Local prefixes**.

The **Local Prefixes** dialog box appears. It allows you to enter prefix exceptions against a local area code. The **Network Call Routing** algorithm handles prefix exceptions for the local area code as long distance, which minimizes toll charges.

See the *ShoreTel 7.5 Administration Guide* for more information about the **Trunk Group** edit page and the **Local Prefixes** dialog box.

NOTE The area codes on the **Site** edit page have no impact on call routing decisions

Telephone Planning and Ordering

This chapter provides information on the types of telephones supported by the ShoreTel 7.5 system and what to consider when planning phones for your system.

Checklist

Review the following telephone planning topics before proceeding to the next chapter:

Task Description	See
<input type="checkbox"/> Application Considerations	page 8-2
<input type="checkbox"/> Fax Machines and Modems	page 8-3
<input type="checkbox"/> ShorePhone Telephones	page 8-4
<input type="checkbox"/> Analog Phone Requirements	page 8-5

Recommendations

The following recommendations will assist you with planning, ordering, and installing your telephones:

- Select your telephones based on user requirements, your wiring infrastructure, and system objectives.
- Order your telephones early. If you need a large quantity of them, you will need to order them several weeks in advance.
- Have your cabling contractor place and test all your telephones. Have the contractor unpack, assemble, place, and test every telephone so that you can avoid this simple but time-consuming task.
- If the telephone you choose requires local power, make sure there is an available outlet at each location.

Application Considerations

General Users

Typically, most users will be satisfied with a standard desk telephone that has a speakerphone and mute button, and supports Caller ID and Message Waiting. ShoreTel IP phones are fully featured and appropriate for most uses. IP phones come with the ShoreTel features available on preprogrammed buttons, and they can be deployed in areas where there are no computers to run the Personal Call Manager.

Workgroup Agents and Supervisors

Because workgroup agents and supervisors typically spend large amounts of time on the telephone, they often like headsets. With the ShoreWare Call Manager, the user can control the telephone in Handsfree Mode and use the analog telephone and headset purely as a highly reliable method for carrying voice.

NOTE ShorePhone analog phones do not display Caller ID for calls forwarded from a workgroup or hunt group.

Operators

Operators typically answer and transfer large numbers of telephone calls throughout the day. Operators should be outfitted with a comfortable headset, and they should use the Handsfree Mode feature, which effectively turns off the dial tone. In this way, operators can use the ShoreWare Call Manager to answer and transfer calls rapidly using their computer, without the need to touch the telephone.

If an operator is using one of the ShorePhone IP212k/230/530/560/560g models, the Automatic Off-Hook Preference feature allows the user to select which audio path (speakerphone or headset) is automatically activated when a call is placed or when an incoming phone call is received. The featured can be configured from Director, PCM, or from the IP phone.

Operators may also benefit from the programmable buttons feature, which allows users to assign functions to the custom keys on the IP212k/230/530/560/560g phones, the BB24 device, and on the IP100 phones. The programmable buttons feature allows a user to assign the extension monitoring feature to one of the custom buttons. The Programmable Toolbars feature allows a system administrator to program common functions and operations to buttons in a user's PCM window so that an operator can perform many common tasks (e.g. answer call, transfer call, invoke URL, etc.) at the click of a button.

Some operators will benefit from a cordless telephone or a cordless headset, which gives them greater mobility.

Receptionists

Receptionists are typically satisfied with a standard desk telephone that supports Caller ID and Message Waiting with a speakerphone and mute button.

Conference Rooms

Most conference rooms are best equipped with a speakerphone from a reputable manufacturer. Since conference rooms do not have a Call Manager client, users may find the ShoreTel IP phone useful. The ShoreTel IP phone provides single-button access to features such as transferring and conferencing calls.

Lobby Phones

A cost-effective wall-mount, slim-line, or desk telephone is adequate for most lobby phones, hall phones, and the like. The IP110/115 models offer a cost-effective telephone that is ideal for use in lobbies, lounges, or other common areas.

Multi-line Phones

ShoreTel 7.5 offers extension monitoring from an IP phone. With this feature, an administrative assistant or workgroup supervisor can monitor up to five system extensions. The extension monitor feature can be enabled for ShoreTel IP phones from the User edit pages of ShoreWare Director. For more information, see the *ShoreTel 7.5 Administration Guide*.

Teleworkers

Both analog and IP phones can be included in a ShoreTel 7.5 system as remote phones. Analog phones require use of the Office Anywhere, while IP phones are supported by setting an IP address range through ShoreWare Director.

Fax Machines and Modems

The ShoreTel 7.5 system supports fax machines and modems in the United States and Canada (and not elsewhere).

Fax and modem calls are more sensitive to network problems than voice conversations. The human ear does not notice a lost packet during a voice conversation, but when a packet is lost during a fax transmission the line may be dropped. During a modem call, a lost packet can cause a retransmission. In the worst case, fax machines and modems will not establish a connection or may drop the call altogether. In general, fax and modem calls work across a local area network, but work on wide area networks only when there is virtually no packet loss and little jitter.

The ShoreTel 7.5 system automatically detects both fax and modem tones, and boosts the voice encoding to a higher value to increase throughput. (G.711 at 64 Kbps is recommended.) It also stops the nonlinear processing of the echo canceller and fixes the size of the jitter buffer to a preset level. In addition, for modems, the echo canceller is frozen or stopped, since the modems use their own network echo cancellers.

Fax Machines

Fax machines require a high-quality IP network for proper operation.

The ShoreTel 7.5 system supports distinctive ringing for inbound calls: calls from external parties have the classic single ring, whereas calls from internal parties have a distinctive double ring. Some fax machines detect the ringing pattern before answering

and might not answer internal calls because of the distinctive ring pattern. In particular, you must turn off the “Intelligent Ring Mode” on some Hewlett-Packard fax machines to receive calls from internal parties.

Modems

The ShoreTel 7.5 system supports “moderate-use” modem applications on the system. This is generally considered to be modem calls up to 28.8 Kbps that do not last longer than 15 minutes. If your application demands greater performance, you should bypass the ShoreTel 7.5 system or move your modem application to a pure IP-based solution.

The expected modem performance in different configurations is as follows:

- Analog connection speeds will not exceed 33.6 Kbps and could be lower. External factors, including poor-quality trunk lines, ISP limitations, and multiple analog-to-digital conversions in the network, can have a significant impact on connection speeds.
- Modem calls demand a high-quality network with virtually no packet loss. Packet loss should not exceed 0.001%, which can be achieved on a local area network or in a wide area network using leased T1 facilities.
- Analog trunk ports on the ShoreGear-120/24, ShoreGear-90, ShoreGear-60/12, ShoreGear-50, and ShoreGear-40/8 should not be used if a digital trunk (T1) is available, since performance will be limited to 28.8 Kbps maximum. Digital trunks on the ShoreGear-T1, ShoreGear-220T1 and ShoreGear-220E1 should be used instead.
- Connection speeds are significantly affected by multiple packet-to-circuit conversions (including modem calls from one ShoreTel 7.5 system to another). If a T1 line is used, modems should be able to connect at K56Flex/V.90 or approximately 48 Kbps.

ShorePhone Telephones

Both analog and IP telephones are available from ShoreTel.

NOTE ShorePhone analog phones do not display Caller ID for calls forwarded from a workgroup or hunt group.

ShorePhone-AP100

The ShorePhone-AP100 telephone provides a cost-effective analog solution for business and includes a high-quality speaker telephone and a large display for caller information.

See “ShoreTel IP Phones and Devices” in Chapter 2, “System Overview,” for a complete description of the ShorePhone-AP100 telephone and the list of voice switches that support it.

ShorePhone-IP110/115/210/212k/230/530/560/560g

The ShorePhone IP phones are supported by the ShoreGear-120/24, ShoreGear-90, ShoreGear-60/12, ShoreGear-50, ShoreGear-40/8, ShoreGear-220T1 and ShoreGear-220E1 voice switches. With ShoreTel IP phones, you create an end-to-end IP network,

or a single-wire-to-the-desktop solution. The ShoreTel IP phone's intuitive user interface provides a high level of comfort when performing telephone operations.

The newer ShorePhone IP212k/230/530/560/560g models offer programmable buttons, making it easy for users to quickly and easily assign common operations to the buttons on their phones. Depending on the model of the IP phone, up to five extensions could be monitored with this feature.

Keep in mind that the “Copy Programmable Buttons” feature can be used to duplicate a programmable button configuration from one phone to another, saving you hours of tedious work as new users are added. Once the programmable buttons on one user's IP phone have been configured, the system administrator can leverage this existing configuration by copying the button profile to subsequent users' phones. (See “Copying Programmable Buttons Configurations” in the *ShoreTel 7.5 Administration Guide* for more information.)

The ShorePhone-IP212k/230/530/560/560g support the Automatic Off-Hook Preference feature, allowing users to select which audio path (speakerphone or headset) is automatically activated when a call is placed or when an incoming phone call is received.

Similarly, the IP212k/230/530/560/560g¹ models have improved support for the Plantronics CS50 wireless headset. Users can answer or end calls by pressing the activation button on their headset when they hear their phone ring.

The ShorePhone-BB24 provides additional shortcut functions for users of the IP212k/230/530/560/560g phones, behaving like an additional set of 24 custom buttons. Additionally, it offers an Ethernet switch port, allowing connection of a PC to the back of the button box.

All ShorePhone IP models (except the IP100) support the ability to load custom ring tones on the phone. The system administrator can load a pair of internal and external ring tones onto each user's phone. Each user can have a unique ring tone, and ring tones must be in the .wav file format. Please refer to the “Configuring IP Phones” chapter in the *ShoreTel 7.5 Administration Guide*.

See “ShoreTel IP Phones and Devices” in Chapter 2, “System Overview,” for a complete description of the ShorePhone IP telephones.

Analog Phone Requirements

The ShoreTel 7.5 system supports standard analog 2500-type telephones, including the CLASS (Custom Local Area Signaling Services) features of Caller ID Name, Caller ID Number, and Message Waiting in the United States and Canada.

Outside the United States and Canada, the ShoreTel 7.5 system supports the local standard analog telephones that support DTMF signaling. Analog Caller ID Number and Message Waiting are supported in the following countries:

- France

-
1. IP560g and some newer IP560 models support this feature while older IP560 models do not. (To recognize a telephone as compatible, flip over the IP560 and check the label with the model number. If the model number ends with a suffix of “-03” or higher, the phone will support this feature. If the suffix ends in “-01” or “-02” the feature is not supported.)

- Germany
- Italy
- Spain
- United Kingdom

Outside of the United States, Canada, and the countries mentioned in the bulleted list above, the features of Caller ID Name, Caller ID Number, and Message Waiting are not supported. See Appendix A, “International Planning and Installation,” for more information.

The following list summarizes key requirements for analog phones:

- **2500-type telephones:** The ShoreTel 7.5 system supports standard 2500-type telephones. (It does not support 500-type rotary telephones.)
- **DTMF signaling, even during power failure:** The ShoreTel 7.5 system uses DTMF tones for signaling with telephones and trunks. It is mandatory that the telephone support DTMF signaling even when power is interrupted, to allow users to make calls in emergency situations.
- **Flash button:** A Flash button is required on analog phone sets to activate call control features from the telephone, including transfer, conference, pickup, and park. ShoreTel *does not* recommend using the hook switch to simulate the Flash button, since this can lead to accidental hang-ups.

If a speakerphone is required:

- **Mute button:** Users in the enterprise typically demand that their speakerphone have a mute button. Since telephones are often designed with the residential market in mind, some speakerphones do not have a mute button, which may lead to end-user complaints.

If message waiting is required (United States and Canada only):

- **CLASS (FSK) message waiting indicator:** CLASS message waiting-compatible telephones provide a highly reliable method for turning message waiting lights on and off.

Telephones that rely on a stutter dial tone to control the message waiting light are unreliable and should be avoided.

The ShoreTel 7.5 system does not support telephones that use voltage-driven message waiting lights.

You should select telephones from a reputable manufacturer. Although most phones on the market are of good quality, ShoreTel recommends that you stay away from “clone” or “low-ball” manufacturers.

Here are some additional considerations:

- **Not too many buttons:** Some telephones come with lots of complicated buttons and options that drive up the price of the device. The ShoreTel 7.5 system delivers advanced features through desktop applications that are integrated with your enterprise tools. Telephones with lots of features and buttons are not necessary.
- **No answering machine:** The ShoreTel 7.5 system includes an integrated voice mail system for all users at all sites. Telephones with integrated answering machines are not necessary.
- **No hold button:** Telephones with a hold button do not actually put the caller on system hold, so the caller will not hear music on hold or have the correct call control status details.

Network Requirements and Preparation

Use the information in this chapter to determine specific network requirements for the ShoreTel 7.5 system. After determining the network requirements, you will be ready to configure your network appropriately.

Checklist

Review the following planning topics before proceeding to the next chapter:

Task Description	See
<input type="checkbox"/> Advantages of Voice Over IP	page 9-2
<input type="checkbox"/> Understanding the Requirements for Toll-Quality Voice	page 9-3
<input type="checkbox"/> WAN Technology Choices	page 9-17
<input type="checkbox"/> IP Address Assignment	page 9-18
<input type="checkbox"/> Time Services	page 9-23
<input type="checkbox"/> Virtual Private Network (VPN)	page 9-24
<input type="checkbox"/> Firewalls	page 9-27
<input type="checkbox"/> Media Encryption	page 9-29
<input type="checkbox"/> Session Initiation Protocol (SIP)	page 9-30
<input type="checkbox"/> Example Network Topologies	page 9-31
<input type="checkbox"/> Computing Admission Control Bandwidth	page 9-33

Overview

The ShoreTel 7.5 system is an IP-based voice solution deployed across your IP network. This allows the components of the system to be located anywhere on your IP network, resulting in a single system for all your voice applications at all locations. This single system approach significantly reduces the complexity associated with legacy systems that consist of multiple PBXs, multiple voice mail systems, multiple auto-attendants, and multiple automatic call distribution systems, each with their unique management interfaces.

Since the ShoreTel 7.5 system becomes another application on your IP network, it is important to understand how the system integrates with your data network. As you migrate your network to include voice as another application across your wide area network, it becomes necessary for your IP LAN and WAN to provide a network that meets the requirements for toll-quality voice. The ability of your network to deliver this performance will vary based on the number of simultaneous calls between locations, the voice quality required, and the other application traffic on the network. Some of the key considerations are:

- Bandwidth
- Service levels
- Addressing

Advantages of Voice Over IP

Going back to the basics of voice, consider a traditional call over the Public Switched Telephone Network (PSTN). The PSTN is a circuit-switched network. A telephone call reserves an end-to-end physical circuit for the duration of the call. This circuit consists of many subsegments within the PSTN, and a subsequent call between the same two endpoints may follow a different path. However, for the duration of the call, the circuit is fully available to that single call.

Packet-switched networks, such as the Internet, do not reserve a circuit between endpoints. Instead, messages or files are broken into many small packets. These packets may take different routes from source to destination, traveling along network circuits that are shared with packets from other sources. These packets travel to the final destination, where they are reconstructed into the original message or file.

One analogy between circuit-switched and packet-switched networks is that of railway versus roadway transportation systems. A railway is similar to a circuit-switched network. The path of the train is essentially reserved, and the whole train travels intact from source to destination. A roadway, on the other hand, is shared among many smaller units, each having the intelligence to find its destination. The railway provides a clear end-to-end path, relatively immune to delays, but at a high overhead cost. The roadway can be used more efficiently, but it is vulnerable to congestion.

The advantage of circuit-switched networks is that they provide dedicated bandwidth between endpoints and therefore can easily guarantee a known, consistent quality of service. Their disadvantage is their poor utilization of network resources, since they demand a dedicated, separate network relative to the packet-switched network. Conversely, the advantage of packet-switched networks is that they provide better utilization of network resources, enable flexible traffic routing, provide a single network to manage, allow for standard voice and data monitoring tools to be used, allow applications to be shared over a common network, and enable applications to become more portable—and this is just the beginning.

Understanding the Requirements for Toll-Quality Voice

The ShoreTel 7.5 system has been designed to deliver the highest possible voice quality. In fact, third-party testing by Miercom has confirmed that the ShoreTel 7.5 system provides both low latency and high voice quality.

With the superior design of the ShoreTel 7.5 system, all that is needed to achieve toll-quality voice communications is to deploy the system over a properly designed network infrastructure. This section provides you with the background to understand the factors involved in engineering an IP network that is ready for voice communications.

In general, to ensure voice quality on the LAN, the ShoreTel 7.5 system must be used in a switched Ethernet network. To ensure voice quality on the WAN, the ShoreTel 7.5 system requires that you do the following:

- Get a service level agreement (SLA) from your WAN service provider.
- Using your routers, prioritize your voice traffic ahead of your data traffic.
- Set the ShoreTel Admission Control feature to ensure that the voice traffic does not flood the WAN links.

With these items taken into consideration, you can simply and easily achieve toll-quality voice using the ShoreTel 7.5 system.

The ShoreTel system has been designed to work in a multi-vendor network environment and therefore leverages standards to ensure voice prioritization.

IP Phone Supported Methods

- Layer 2 IP Precedence (802.1p and 802.1q) (this only applies on the LAN)
- Layer 3 Differentiated Services Code Point (DiffServ/ToS)
- Layer 4 UDP 5004

ShoreGear Voice Switch Supported Methods

- Layer 3 Differentiated Services Code Point (DiffServ/ToS)
- Layer 4 UDP 5004

Network Requirements

When your voice traffic travels across your IP network, you must ensure that your network does all of the following:

- Delivers enough bandwidth
- Meets the latency and jitter requirements
- Meets the packet loss requirements for toll-quality voice

You also need to prioritize your voice traffic over your data traffic and configure the ShoreTel 7.5 system's Admission Control feature.

Bandwidth Requirements

The amount of bandwidth for voice calls depends on these details:

- Number of simultaneous calls
- Voice encoding scheme in use
- Amount of signaling overhead

Voice Encoding

Table 9-1 Voice Encoding^a

	Linear Broadband	Linear	G.711	ADPCM	G.729a
Sample rate	16 KHz	8 KHz	8 KHz	8 KHz	8 KHz
Effective sample size	16 bits	16 bits	8 bits	4 bits	1 bit
Data rate	256 Kbs	128 Kbps	64 Kbps	32 Kbps	8 Kbps
Supported end points	ShorePhone IP110/115/210/212k/230/530/560/560g phones	All ShoreGear ShorePhones	All ShoreGear ShorePhone IP110/115/210/212k/230/530/560/560g phones	All ShoreGear	All ShoreGear ShorePhone IP110/115/210/212k/230/530/560/560g phones

a. Voice Activity Detection (VAD) / Silence Suppression is not supported.

Within a site, linear broadband encoding is recommended, since bandwidth in the LAN is inexpensive and readily available. Between sites, G.729a is recommended because it uses the least amount of bandwidth. The linear codec provides slightly higher voice quality than G.711, but should not be used if there are any bandwidth concerns.

If you select linear broadband or linear encoding, end points that do not support either codec will negotiate for the highest quality codec for both end points, and G.711 is the only high-quality codec shared by all end points.

ShoreTel TCP and UDP Port Usage

ShoreTel 7.5 uses the following TCP and UDP ports for traffic.

Table 9-2 Port Usage

	DESTINATION DEVICE							
	Switch	IP Phone	Desktop (PCM)	SoftPhone	DVM Server	HQ/Director Server	Other	
ORIGINATING DEVICE	Switch	Call Control UDP 5440 - Location Service UDP 5441 - Call Control UDP 5443 - Bandwidth Manager UDP 5445 - Admission Control Media Stream UDP 5004 RTP [if dynamic 1024-65535]	Call Control UDP 2427 MGCP Media Stream UDP 5004 RTP [if dynamic 1024-65535]		Call Control UDP 2427 MGCP Media Stream UDP 5004 RTP [if dynamic 1024-65535]	RPC Connection Negotiation TCP 111 RPC Port Mapper UDP 111 RPC Port Mapper Call Control TCP 1024-65535 RPC - NCC UDP 2727 MGCP - Media proxy UDP 5440 - Location Service UDP 5441 - Call Control UDP 5442 - DRS UDP 5443 - Bandwidth Manager UDP 5445 - Admission Control UDP 5446 - DRS keepalive Configuration Control TCP 21 FTP CTL - Boot files TCP 20 FTP DATA - Boot files Media Stream UDP 5004 RTP [if dynamic 1024-65535]	RPC Connection Negotiation TCP 111 RPC Port Mapper UDP 111 RPC Port Mapper Call Control TCP 1024-65535 RPC - NCC UDP 2727 MGCP - Media proxy UDP 5440 - Location Service UDP 5441 - Call Control UDP 5442 - DRS UDP 5443 - Bandwidth Manager UDP 5445 - Admission Control UDP 5446 - DRS keepalive Configuration Control TCP 21 FTP CTL - Switch Boot TCP 20 FTP DATA - Switch Boot Media Stream UDP 5004 RTP [if dynamic 1024-65535]	Configuration Control UDP 67 DHCP Server Maintenance UDP 162 SNMP TRAP Call Control UDP 5060 SIP Media Stream UDP 1024-65535 RTP - for SIP
	IP Phone	Call Control UDP 2727 MGCP Media Stream UDP 5004 RTP [if dynamic 1024-65535]	Call Control UDP 5554 - BB to Phone Media Stream UDP 5004 RTP [if dynamic 1024-65535]		Media Stream UDP 5004 RTP [if dynamic 1024-65535]	Configuration Control TCP 21 FTP CTL - Config TCP 20 FTP DATA - Config ICMP PING Media Stream UDP 5004 RTP [if dynamic 1024-65535]	Configuration Control TCP 21 FTP CTL - Config TCP 20 FTP DATA - Config ICMP - PING UDP 5004 RTP [if dynamic 1024-65535]	Configuration Control UDP 67 DHCP Server UDP 123 SNTP

Table 9-2 Port Usage

		DESTINATION DEVICE						
		Switch	IP Phone	Desktop (PCM)	SoftPhone	DVM Server	HQ/Director Server	Other
ORIGINATING DEVICE	Desktop (PCM)					RPC Connection Negotiation TCP 135 MS RPC Port Mapper Call Control TCP 1024-65535 MS RPC - Remote TAPI Configuration Control TCP 5440 - CSIS	RPC Connection Negotiation TCP 135 MS RPC Port Mapper Call Control TCP 1024-65535 MS RPC - Remote TAPI Configuration Control TCP 80 HTTP - Web client, Online help TCP 5440 - CSIS	
	SoftPhone	Call Control UDP 2727 MGCP Media Stream UDP 5004 RTP [if dynamic 1024-65535]	Media Stream UDP 5004 RTP [if dynamic 1024-65535]		Media Stream UDP 5004 RTP [if dynamic 1024-65535]	Media Stream UDP 5004 RTP [if dynamic 1024-65535]	Configuration Control TCP 80 HTTP Media Stream UDP 5004 RTP [if dynamic 1024-65535]	
	DVM Server	RPC Connection Negotiation TCP 111 RPC Port Mapper UDP 111 RPC Port Mapper Call Control TCP 1024-65535 MS RPC - NCC UDP 2427 MGCP - Media proxy UDP 5440 - Location Service UDP 5441 - Call Control UDP 5443 - Bandwidth Manager UDP 5445 - Admission Control Configuration Control TCP 1024-65535 - Firmware download Media Stream UDP 5004 RTP [if dynamic 1024-65535]	Media Stream UDP 5004 RTP [if dynamic 1024-65535]	Call Control TCP 1024-65535 - Remote TAPI	Media Stream UDP 5004 RTP [if dynamic 1024-65535]	RPC Connection Negotiation TCP 135 MS RPC Port Mapper Call Control TCP 1024-65535 MS RPC - DTAS/TMS TCP 5441 - Call data UDP 5440 - Location Service UDP 5441 - Call Control UDP 5443 - Bandwidth Manager UDP 5445 - Admission Control UDP 5446 - DRS keepalive Distributed Voice Mail TCP 25 SMTP - Voice Mail transport	RPC Connection Negotiation TCP 111 RPC Port Mapper UDP 111 RPC Port Mapper Call Control TCP 135 MS RPC Port Mapper Maintenance TCP 1024-65535 MS RPC - Quicklook Call Control TCP 1024-65535 MS RPC - DTAS/TMS TCP 1024-65535 MS RPC - DB access TCP 5441 - Call data UDP 5440 - Location Service UDP 5441 - Call Control UDP 5443 - Bandwidth Manager UDP 5445 - Admission Control UDP 5446 - DRS keepalive Distributed Voice Mail TCP 25 SMTP - Voice Mail transport	Voice Mail Notification TCP 25 SMTP

Table 9-2 Port Usage

	DESTINATION DEVICE							
	Switch	IP Phone	Desktop (PCM)	SoftPhone	DVM Server	HQ/Director Server	Other	
ORIGINATING DEVICE	HQ/Director Server RPC Connection Negotiation TCP 111 RPC Port Mapper UDP 111 RPC Port Mapper Call Control TCP 1024-65535 RPC - NCC UDP 2427 MGCP - Media proxy UDP 5440 - Location Service UDP 5441 - Call Control UDP 5443 - Bandwidth Manager UDP 5445 - Admission Control Configuration Control TCP 1024-65535 - Firmware download Media Stream UDP 5004 RTP [if dynamic 1024-65535] Maintenance TCP 5555 - Diagnostic ipbxctl	Media Stream UDP 5004 RTP [if dynamic 1024-65535] Maintenance TCP 5555 - Diagnostic phonectl	Call Control TCP 1024-65535 - Remote TAPI	Media Stream UDP 5004 RTP [if dynamic 1024-65535]		RPC Connection Negotiation TCP 111 RPC Port Mapper UDP 111 RPC Port Mapper TCP 135 MS RPC Port Mapper Maintenance TCP 1024-65535 RPC - Quicklook Call Control TCP 1024-65535 MS RPC - DTAS/TMS TCP 1024-65535 MS RPC - DB Notify TCP 5441 - Call data UDP 5440 - Location Service UDP 5441 - Call Control UDP 5443 - Bandwidth Manager UDP 5445 - Admission Control UDP 5446 - DRS keepalive Distributed Voice Mail TCP 25 SMTP - Voice Mail transport		Voice Mail Notification TCP 25 SMTP CDR TCP 3306 - CDR archive on remote server
	Other Configuration Control UDP 68 DHCP Client Call Control UDP 5060 SIP Media Stream UDP 1024-65535 RTP - for SIP Maintenance TCP 23 Telnet UDP 161 SNMP	Configuration Control UDP 68 DHCP Client Maintenance TCP 23 Telnet				Maintenance TCP 80 HTTP - Quicklook	Configuration Control TCP 80 HTTP - Director	

Bandwidth in the LAN

For LAN calls using the voice switches, 10 msec of voice samples are encapsulated in a Real Time Protocol (RTP) packet before being transmitted onto the LAN. For IP phones and SoftPhones, 20 msec of voice samples are encapsulated in an RTP packet before being transmitted onto the network.

The protocol overhead consists of 12 bytes for the RTP header, 8 bytes for the UDP header, 20 bytes for the IP header, and 26 bytes for the Ethernet framing. When ADPCM voice encoding is used, an additional 4 bytes are added to the voice data for decoding purposes. This yields an effective LAN bandwidth as shown in Table 9-3.

Table 9-3 LAN Bandwidth—Bytes

	Linear Broadband	Linear	G.711	ADPCM	G.729a	G.729a
Voice data (10 msec)	320	160	80	40+4 ^a	20 (20 msec) ^b	30 (30 msec)
RTP header	12	12	12	12	12	12
UDP header	8	8	8	8	8	8
IP header	20	20	20	20	20	20
Ethernet header and framing ^c	26	26	26	26	26	26
Total bytes per packet ^d	386	226	146	110	86 (20 msec)	96 (30 msec)
Bandwidth for voice only ^e	256 Kbps	128 Kbps	64 Kbps	32 Kbps	8 Kbps	8 Kbps
Bandwidth with overhead	309 Kbps	181 Kbps	117 Kbps	88 Kbps	34 Kbps	34 Kbps

- When ADPCM voice encoding is used, an additional 4 bytes are added to the voice data for decoding purposes.
- G.729a is supported in 10-msec, 20-msec, and 30-msec packets in this release.
- Ethernet framing = 14 bytes of Ethernet header, a 4-byte checksum, and 8 bytes of additional framing.
- Voice data bytes per packet = (# bits/sample) x (8 samples/msec) x (10 msec/packet) / (8 bits/byte).
- Bandwidth = (# bytes/10 msec) x (8 bits/byte).

For calls between analog telephones, voice bandwidth is used only on the connection between the voice switches. For calls involving IP telephones, the bandwidth is required between the IP phones at the user's desktop. This means that for IP telephones, network planning must include provisioning capacity to each IP phone.

When SIP is not enabled, RTP traffic is always sent to UDP port 5004. The source port is random. When SIP is enabled, both the source and destination ports are random.

Bandwidth in the WAN

Increasing the number of voice samples per packet decreases the bandwidth required (since the percentage of signaling overhead is reduced); however, it also increases the latency of the voice call, which can result in poorer voice quality. Consequently, the ShoreTel 7.5 system uses 10-msec voice packets on the LAN, where bandwidth is readily available, and 20-msec voice packets on the WAN, where bandwidth conservation is more important. WAN calls are calls made between ShoreTel system sites.

For WAN calls, routers with RTP Header Compression (cRTP) reduce the 40 bytes in the IP + UDP + RTP header to 4 bytes. If you want to use cRTP, make sure the router's implementation of cRTP does not increase the latency or jitter of the voice traffic, since this can have a negative impact on voice quality. If the router does increase latency or jitter with cRTP, add this to your overall expected latency and make sure you still have sufficient performance for acceptable voice quality.

Table 9-4 shows the resulting effective WAN bandwidth. It does not include the overhead associated with the underlying WAN network protocol, such as HDLC, frame relay, ATM, and VPN; however, the ShoreTel admission control software computes bandwidth requirements according to the data in this table and assumes a PPP header-size for computations.

Table 9-4 WAN Bandwidth—Bytes

	Linear Broadband	Linear	G.711	ADPCM	G.729a	G.729a
Voice data (20 msec)	640	320	160	80+4 ^a	20	30
RTP header	12	12	12	12	12	12
UDP header	8	8	8	8	8	8
IP header	20	20	20	20	20	20
PPP header	5	5	5	5	5	5
Total bytes per packet ^b	685	365	205	129	65	75
Bandwidth for voice only ^c	256 Kbps	128 Kbps	64 Kbps	32 Kbps	8 Kbps	8 Kbps
Bandwidth including overhead	284 Kbps	146 Kbps	82 Kbps	52 Kbps	26 Kbps	26 Kbps
Bandwidth after cRTP	260 Kbps	132 Kbps	68 Kbps	37 Kbps	12 Kbps	12 Kbps

- a. When ADPCM voice encoding is used, an additional 4 bytes are added to the voice data for decoding purposes.
- b. Voice data bytes per packet = (# bits/sample) x (8 samples/msec) x (20 msec/packet) / (8 bits/byte)
- c. Bandwidth = (# bytes/20 msec) x (8 bits/byte)

Latency

Latency is the amount of time it takes for one person's voice to be sampled, digitized (or encoded), packetized, sent over the IP network, de-packetized, and replayed to another person. This one-way delay, from "mouth-to-ear," must not exceed 100 msec for toll-quality voice, or 150 msec for acceptable-quality voice. If the latency is too high, it interferes with the natural flow of the conversation, causing the two parties to confuse the latency for pauses in speech. The resulting conversation is reminiscent of international calls over satellite facilities.

The latency introduced by the ShoreTel 7.5 system can be understood as follows: When a person talks, the voice is sampled by the ShoreGear voice switch, generating a latency of 5 msec. If the call does not traverse ShoreTel voice switches and is handled completely internally by the switch, the latency is generated by the basic internal pipeline of the switch. In this case, the switch samples the voice, processes it, combines it with other voice streams (switchboard), and then converts it back to audio for output to the phone in 5-msec packets, for a total latency of about 17 msec.

When the call transfers between voice switches, the voice is packetized in larger packets—10-msec for LAN and 20-msec for WAN—to reduce network overhead. The larger packets take more time to accumulate and convert to RTP before being sent out. On the receive side, the incoming packets are decoded and placed in the queue for the switchboard. For a 10-msec packet, this additional send/receive time is approximately 15 msec, and for a 20-msec packet it is about 25 msec.

For IP phones, the latency is 20 ms in the LAN and 30ms in the WAN.

When the codec is G.729a, the encoding process takes an additional 10 msec and the decoding process can take an additional 10 msec.

See Table 9-5 for specific information about latency on the ShoreTel 7.5 system.

Table 9-5 Latency

Configuration	Overhead	Encoding	Frame Size -5	Jitter Buffer ^a	Decoding	Total (+/- 5 msec) ^b
Switch	17	0	0	Varies	0	17
LAN	17	5	5	Varies	5	32 + Jitter Buffer
WAN	17	5	15	Varies	5	42 + Jitter Buffer
G.729a (LAN and WAN)	17	15	15	Varies	15	62 + Jitter Buffer

- a. The jitter buffer varies, depending on network conditions. See below for more information.
- b. If a call comes in on a trunk through either T1/E1 or analog loop-start, the total latency is increased by the delay in the PSTN. You must add this latency to the total latency. Latency for the PSTN varies; however, it is probably a minimum of 10 msec (for local), and it could be as high as hundreds of msec (for long international calls).

Jitter for Voice Switches

Jitter is the variation of latency across the network and the variation in packet processing inside the switches. To compensate for jitter, the ShoreGear voice switches continuously measure the jitter in the system and dynamically change the size of the receive jitter buffers to optimize voice quality.

If the jitter buffer is too small, there can be packet loss from buffer underflows. This occurs when the jitter buffer runs out of valid voice samples. If the jitter buffer is too

large, there will be unnecessary latency. Both conditions have a negative impact on voice quality.

The jitter buffer starts at the minimum size of 0 msec as packets from the network are placed into the switchboard queue for immediate processing. When jitter is detected on the network, the jitter buffer dynamically increases in increments of 5 msec to compensate for increased jitter and decreases in size in reaction to less jitter. The maximum value of the jitter buffer is set by ShoreWare Director and ranges from 20 to 300 msec, with a default of 50 msec.

As the jitter increases on the network and the jitter buffer needs to be increased to guarantee timely audio play, the latency of the audio also increases. The system attempts both to maintain a minimum jitter buffer size that provides good-quality voice without dropping packets and to provide minimum latency.

For IP phones that are configured into the ShoreTel system, the jitter buffer is not configurable. The minimum jitter buffer is 10 msec, and the maximum is 80 msec.

NOTE Maximum values greater than 100 should rarely be necessary. If needed, this could indicate a problem in your network that should be addressed in another way.

Packet Loss

Lost packets can occur on the IP network for any number of reasons. Packet loss above 1% begins to adversely affect voice quality. To help reduce this problem, the ShoreGear voice switches have a feature called lost packet concealment. When there is no voice sample to be played, the last sample available is replayed to the receiving party at a reduced level. This is repeated until a nominal level is reached, effectively reducing the clicking and popping associated with low levels of packet loss.

NOTE Fax and modem calls demand essentially zero packet loss to avoid missing lines on fax calls and to avoid dropped modem calls. In addition, fax and modem calls, when detected, may change to a higher-rate codec.

Summary of the Network Requirements

Table 9-6 summarizes the network requirements for bandwidth, latency, jitter, and packet loss.

Table 9-6 Network Requirements

Parameter	Requirement
Bandwidth (WAN)	With ADPCM and no RTP Header Compression: 52 Kbps per call With G.729a and no RTP Header Compression: 26 Kbps per call With G.711 and no RTP Header Compression: 82 Kbps per call NOTE: If your network uses VPN, bandwidth use is affected.
Latency and jitter for toll quality	< 100 msec total 100 msec less 42 msec allocated for the ShoreTel 7.5 system yields a 58 msec budget for the network. When G.729a encoding is used, 100 msec less 62 msec allocation for the ShoreTel 7.5 system yields a 38 msec budget for the network.

Table 9-6 Network Requirements

Parameter	Requirement
Latency and jitter for acceptable quality	<p>< 150 msec total</p> <p>150 msec less 42 msec allocated for the ShoreTel 7.5 system yields a 108 msec budget for the network.</p> <p>When G.729a encoding is used, 150 msec less 62 msec allocated for the ShoreTel 7.5 system yields an 88 msec budget for the network.</p>
Packet loss	< 1% for voice calls, and no packet loss for fax and modem calls

Impact of Long Network Outages

The ShoreTel 7.5 system is a completely distributed system in which each ShoreGear voice switch provides all call control functionality for inbound and outbound calls, as well as features such as transfer, conference, pickup, and trunk selection. When there is a long network outage, the switches will detect the problem and run isolated from the switches that can no longer be reached. In the ShoreTel 7.5 system, switches communicate every 30 seconds and disconnect when there is no response after 60 seconds.

Bandwidth Management

In addition to the network requirements discussed above, bandwidth management techniques need to be deployed to ensure that real-time voice data is not affected by bursts or high amounts of data traffic.

Local Area Network

To manage bandwidth in the local area network (intra-site) and meet the requirements for toll-quality voice, use Ethernet switching. Ethernet switching is cost effective and simple to provision. Your LAN configuration requirements will vary depending on your infrastructure and whether your network includes IP phones.

IP phones sample the user's voice and convert the voice signal to IP packets using the Real Time Protocol (RTP). These packets must be tagged for higher prioritization in the network. ShoreTel IP phones have embedded Ethernet switches and will automatically prioritize voice traffic ahead of any data traffic coming from daisy-chained personal computers (for example, large files transfers and email).

On the local area network, there are several methods to prioritize voice packets, including:

- IP Precedence = 5 (configurable, recommendation is 5)
- DiffServ/ToS = EF (configurable, recommendation is EF)
- UDP (Dest. port) = 5004 (when not using SIP)

The Ethernet switch infrastructure should be configured to prioritize traffic using one of these methods. This allows the voice traffic arriving at the switch to travel ahead of the data traffic.

NOTE ShoreTel customers typically choose to prioritize DSCP since this configuration is easy to set up on smart Ethernet switches.

When IP phones are used, the desktop connection to the user's computer and phone must also be part of your switched Ethernet network. The user's phone is connected to the port on the Ethernet switch, and the user's computer or other data device is

connected to the integrated two-port Ethernet switch inside the IP phone. In this configuration, the switch port connected to the phone must be configured to prioritize the voice packets from the phone above the data packets.

NOTE PCs connected through IP phones will lose their connection to the network if the IP phone loses power.

Voice quality can be guaranteed by putting each of the ShoreGear voice switches and the ShoreWare server on its own Ethernet switch port. A network with this topology meets the bandwidth, jitter, and latency requirements for toll-quality voice without the additional need for special prioritization of voice packets.

Virtual LANs

An alternative method to prioritize voice over data is to create a separate virtual LAN strictly for your voice traffic. The ShoreTel IP phone as well as the ShoreGear voice switches can be configured on a specific VLAN.

Set the voice VLAN for higher prioritization in the network. The Ethernet switch infrastructure needs to be configured to prioritize the voice VLAN. This allows the voice traffic arriving at the switch to travel ahead of the data traffic.

Wide Area Network

To manage bandwidth in the wide area network, prioritize your voice traffic ahead of your data traffic. The voice packets on the ShoreTel 7.5 system always travel on UDP port 5004, so you simply prioritize this UDP port within your routers with priority queueing. You can prioritize based on the voice switch IP address, the MAC address, or the physical port on the Ethernet switch. As an additional step, you can also prioritize the distributed call control signaling that always travels on UDP port 5440 through UDP port 5445.

If the voice traffic for the call needs to flow across a WAN link, the routers needs to be configured to prioritize voice ahead of data using one of the two tagging methods, DiffServ/ToS or UDP 5004.

NOTE ShoreTel customers typically choose to prioritize UDP 5004 to avoid costly network upgrades since older routers and more Ethernet switches support this function. Additionally, configuring UDP 5004 for prioritization is easy to set up.

Client Bandwidth

ShoreTel Call Managers communicate with the ShoreWare server for call information and control, configuration changes, and advanced services such as extension monitoring. Table 9-7 provides an estimate of the client bandwidth used for each of the Call Manager applications.

Table 9-7 Typical Call Manager Bandwidth Use

Call Manager	Bandwidth Use
Personal	.2 Kbps
Advanced	.2 Kbps
Operator Extension Monitor	.2 Kbps + 1.5 Kbps 1.5 Kbps per monitored extension
Workgroup Agent Queue Monitor	.25 Kbps 6.5 Kbps per queued call

Table 9-7 Typical Call Manager Bandwidth Use

Call Manager	Bandwidth Use
Workgroup Supervisor	.25 Kbps
Queue Monitor	6.5 Kbps per queued call
Agent Monitor	1.5 Kbps per agent

Distributed Call Control Signaling

Voice switches maintain communication with each other. A single voice switch maintaining basic connectivity with 59 other voice switches consumes less than 1.5 Kbps of bandwidth.

Admission Control in the Wide Area Network

To ensure that your voice traffic does not overwhelm the wide area network and degrade voice quality, the ShoreTel 7.5 system has an Admission Control feature. From ShoreWare Director, you can limit the amount of WAN bandwidth used for telephone calls on a per-site basis. For a telephone call to be established between sites, admission control must be met at both sites. If the admission control limit is reached at a site, additional calls cannot be placed to or from the site, thus ensuring the voice quality of calls already in progress. If the user is making an outbound call, the call is automatically routed out of a trunk at the site. When making an extension-to-extension call, the user is informed that there is insufficient network bandwidth to complete the call. The user can try again later or dial the external number of the other user.

NOTE If PSTN failover is enabled for a user extension, the user's extension-to-extension calls are automatically routed to the public switched telephone network (PSTN) when there is insufficient bandwidth for an IP connection to phone.

Spanning Tree Protocol

Spanning Tree Protocol (STP) is used by Ethernet switches and routers to determine if there are multiple paths on the network between any two endpoints. You must disable STP on any network port that has a ShoreGear switch or ShoreWare server connected.

Traffic Shaping to Reduce Bottlenecks

Given that more applications are requiring WAN bandwidth, the need to optimize is increasingly important. This is particularly true for enterprises that want to deploy voice over virtual networks where quality of service and traffic shaping are required. With traffic shaping, it is possible to set policies that determine who or what gets top priority. For example, by prioritizing the various flows of traffic, an administrator can make sure that UDP (voice) traffic gets a higher priority than FTP (file download) traffic.

Echo Cancellation

Echo in a voice communication system is caused by signal reflections generated by the electrical circuits called hybrids that convert between two-wire (shared transmit and receive pair) and four-wire circuits (separate transmit and receive pairs). These reflections cause the speaker's voice to be heard in the speaker's ear as delayed by many

milliseconds. Echo is present even in the traditional circuit-switched telephone network, but since the delay in a local circuit-switched call is so low, the echo is not perceivable. On a packet-based voice network, there is more delay, and the speaker may perceive the echo if it is not properly cancelled.

The DSP software on the ShoreGear voice switches provides dynamic echo cancellation. When a user places an extension-to-trunk call using an analog trunk on a ShoreGear-120/24, ShoreGear-90, ShoreGear-60/12, ShoreGear-50, or ShoreGear-40/8 voice switch, the user's voice bounces off the initial four-wire to two-wire conversion in the analog trunk circuit, then off the two-wire to four-wire in the central office, and finally off the called party's telephone. This echo returns from the central office and is cancelled by the echo canceller on the trunk port of the voice switch. The echo from the called party's phone, however, is usually cancelled or suppressed by the central office. If this echo is not cancelled, the user may hear himself or herself talking.

In the opposite direction, the external person's voice bounces off the user's telephone. This echo returns from the telephone and is cancelled by the echo canceller on the telephone port of the voice switch. If this echo is not cancelled, the external party hears himself or herself talking. This same process of echo cancellation applies to extension-to-extension as well as trunk-to-trunk calls.

The ShoreGear-120/24, ShoreGear-90, ShoreGear-60/12, ShoreGear-50, ShoreGear-40/8, ShoreGear-T1, and ShoreGear-E1 can cancel echo received up to 16 msec after being sent.

Resultant Voice Quality

As stated earlier, the ShoreTel 7.5 system has been recognized for excellent voice quality. This is a result of the excellent hardware and software design that minimizes latency and dynamically adapts to the effects of jitter, packet loss, and echo introduced by the network.

There are two subjective testing methods that are used to evaluate voice quality. A method called Mean Opinion Score (MOS) is an open test in which a variety of listeners judge the quality of a voice sample on a scale of 1 (low) to 5 (high). There is general industry agreement on the theoretical maximum MOS value on a per codec basis that can be achieved (see Table 9-8).

Table 9-8 Theoretical MOS Maximum Scores

Codec	Data Rate (Kbps)	MOS
Linear	128	4.5
G.711	64	4.1
ADPCM	32	3.85
G.729a	8	3.85

Both the MOS test method and an interactive test method were used by Miercom. The interactive test focused on the conversational quality of the call. The results are shown in Table 9-9. The ShoreTel MOS scores are higher than the industry-standard values.

This is likely a result of the subjective nature of the head-to-head test, which scores a relative ranking rather than an absolute ranking.

Table 9-9 ShoreTel MOS and Interactive Test Results

Codec	Data Rate (Kbps)	MOS	Interactive
Linear	128	Not tested	Not tested
G.711	64	4.46–4.87	4.66
ADPCM	32	3.96–4.05	4.33
G.729a	8	Not tested	Not tested

WAN Technology Choices

Minimum Bandwidth Requirements

The minimum WAN bandwidth required to deploy a voice switch at a site depends on the number of calls expected. With ADPCM, a single call consumes 52 Kbps, and if this call becomes a conference call, another 52 Kbps is needed, yielding a total of 104 Kbps. From a broadband perspective, the first available technology is 128 Kbps (ISDN), which leaves only 24 Kbps for other IP traffic. For teleworking applications, where only a single call is needed, 128 Kbps can be used. For other sites on the voice network, the minimum bandwidth recommended is 384 Kbps.

Various technologies are available from different service providers to provide IP connectivity between locations, as shown in Table 9-10.

Table 9-10 IP Connectivity Chart

Technology	Upstream Bandwidth Kbps	Downstream Bandwidth Kbps	Calls with ADPCM ^a
T1	1544	1544	26
Frame Relay	Varies	Varies	Varies
SDSL	1544	1544	26
SDSL	1024	1024	17
SDSL	768	768	13
SDSL	512	512	8
SDSL	384	384	6
IDSL	144	144	1 call only
ADSL	128	1,000 (varies)	1 call only
Cable	128 (varies)	1,000 (varies)	1 call only
ISDN BRI	128	128	Not supported
Dial-up modem	28.8–56	28.8–56	Not supported

a. Your bandwidth will vary, based on the WAN overhead for your particular system.

Leased T1

Leased T1 facilities are the most robust WAN technology available. Leased T1s are point-to-point links that inherently meet the network requirements for toll-quality voice since no ISP is involved. Dedicated T1s are priced on a per unit distance basis, making this a very cost-effective option over short distances.

Frame Relay

Frame Relay is a viable option as long as you get a committed information rate (CIR) that meets the bandwidth and network requirements for toll-quality voice communications.

SDSL

SDSL is considered “business-to-business” DSL in which you can negotiate a service level agreement with the service provider. Unlike T1, SDSL is priced on a flat bandwidth basis, making the price “distance insensitive” and cost-effective over long distances.

Although this is an excellent option, especially moving forward, ShoreTel has found the use of SDSL challenging, since the service providers often commit to a Service Level Agreement (SLA) they cannot fulfill. Many service providers have grown very fast, and the IP network is a patchwork of devices. These service providers are usually geared toward providing bandwidth for typical data applications, and a voice application highlights weaknesses in their network. Only with joint troubleshooting of the service provider’s network, using tools such as ping plotters, has ShoreTel been able to achieve the SLA the service provider promised.

IDSL

IDSL modems, which have an uplink and downlink speed of 144 Kbps, can be considered for teleworking applications. The actual performance will vary based on your service provider and your applications.

ADSL

ADSL modems, which have an uplink speed of 128 Kbps, can be considered for teleworking applications. The actual performance will vary based on your service provider and your applications.

Cable Modems

Cable modems, which can have an uplink speed of 128 Kbps, can be considered for teleworking applications. The actual performance will vary based on your service provider and your applications.

ISDN BRI

ISDN BRI is not supported at this time.

Dial-Up Modems

Because of their inherent latency and low bandwidth, dial-up modems are not supported.

IP Address Assignment

Each ShoreGear voice switch requires one IP address. Each software server must be configured with a static IP address. You can use one of the following to serve an IP address to a voice switch:

- DHCP on a network server
- The BOOTP server integrated into ShoreWare Director

- The maintenance port on the front of the ShoreGear-120/24, ShoreGear-90, ShoreGear-60/12, ShoreGear-50, ShoreGear-40/8, ShoreGear-220T1, ShoreGear-220E1, ShoreGear-T1, or ShoreGear-E1

This is summarized in Table 9-11:

Table 9-11 IP Address Service

Voice Switch	DHCP	BOOTP	Maintenance Port
ShoreGear-120/24	Yes	Yes	Yes
ShoreGear-60/12	Yes	Yes	Yes
ShoreGear-40/8	Yes	Yes	Yes
ShoreGear-T1	Yes	Yes	Yes
ShoreGear-E1	Yes	Yes	Yes

If a voice switch has been configured to request a dynamic IP address, it puts a DHCP/BOOTP request on the network when powered on. If the voice switch receives a response, it uses the new IP address. If no response is received, it reverts to the previous IP address. If there is no previous IP address, the voice switch continues trying to get an IP address.

If you use a DHCP server on the network, ShoreTel recommends that you configure reserved IP addresses such that the IP addresses of the voice switches do not inadvertently change.

If you do not have a DHCP server on the network, you can use the BOOTP server integrated into ShoreWare Director to assign IP addresses. ShoreTel does not support running DHCP on the ShoreWare server for serving either ShoreGear voice switches or other equipment.

Additionally, the ShoreGear-120/24, ShoreGear-90, ShoreGear-60/12, ShoreGear-50, ShoreGear-40/8, ShoreGear-220T1, ShoreGear-220E1, ShoreGear-T1, and ShoreGear-E1 have a maintenance port for the purposes of configuring the networking parameters.

The following recommendations will assist you with IP address assignment:

- Ensure there is only one DHCP server on the network. If you have multiple DHCP servers on the network, you risk giving the voice switches an errant IP address that will remove the voice switches from service until the problem is corrected.
- The ShoreTel system must be on a private network in some situations and on a public network in other instances. For example, if the enterprise is using a firewall with Network Address Translation (NAT), all remote facilities must establish VPN connections to the headquarters and be on the same private network. If the enterprise is not using NAT but is using firewalls, all remote locations must use public IP addresses.
- Each IP telephone must be configured with a single unique IP address. You can configure the IP telephone through DHCP or manually on the telephone.
- Telephones at different sites must be configured on different subnets or assigned from different address ranges so that the ShoreTel system can properly assign the voice switch for the IP telephone site.

Configuring DHCP for ShoreTel IP Phones

The ShoreTel server provides the IP phones with the latest application software and the configuration information that enables the IP phone to be automatically added to the ShoreTel 7.5 system. The ShoreTel server's address must be provided to the phone as a vendor-specific DHCP option. ShorePhone-IP100 telephones are preconfigured to look for the ShoreTel server's address to be specified as Vendor Specific DHCP option 155. ShorePhone-IP110/115/210/212k/230/530/560/560g telephones are preconfigured to look for the ShoreTel server's address to be specified as Vendor Specific DHCP option 156. If these options are not available, the ShoreTel IP phones will use option 66.

To set up DHCP option 155 for ShorePhone-IP100 telephones on a Microsoft DHCP server:

- Step 1** Open **DHCP Manager** on your Microsoft DHCP server.
- Step 2** Right-click the DHCP server, and select **Set pre-defined options**.
- Step 3** Click **Add**.
- Step 4** Set **Name** to IP Phone Boot Server.
- Step 5** Set **Data Type** to IP address.
- Step 6** Set **Code** to 155 and add a description, if desired.
- Step 7** Navigate to the scope options and add option 155.
- Step 8** Set the value of option 155 to the IP address of your ShoreWare server.
- Step 9** Connect the Ethernet cable to the data jack on the back of the IP phone.

The phone downloads the latest bootROM and firmware from the ShoreTel server and in the process, reboots several times. When the phone displays the date and time, the upgrade process is complete.

To set up DHCP option 156 for ShorePhone-IP110/115/210/212k/230/530/560/560g telephones on a Microsoft DHCP server:

- Step 1** Open **DHCP Manager** on your Microsoft DHCP server.
- Step 2** Right-click the DHCP server, and select **Set pre-defined options**.

NOTE If your organization is separated into separate subnets, make sure to select the proper subnet. For example, if you have a global organization and would like to configure the DHCP server to deliver the Spanish tones and cadences only to the IP phones in your office in Spain, you should make sure to select that particular subnet of users. If you do not specify the subnet, then all phones that boot from this DHCP server will receive Spanish tones and cadences.

- Step 3** Click **Add**.
- Step 4** Set **Name** to IP Phone Boot Server.

Step 5 Set **Data Type** to String.

Step 6 Set **Code** to 156 and add a description, if desired.

Step 7 Navigate to the **scope** options and add option 156.

Step 8 Set the value of option 156 to:

`ftpservers=ip_address, country=n, language=n, layer2tagging=n, vlanid=n`

where `ip_address` equals the IP address of your ShoreWare Headquarters server.

Refer to Table 9-12 for a list of country codes. Selecting the appropriate country code ensures that the phone has the proper ring tones and cadences needed for a particular country.

Refer to Table 9-13 for a list of language codes. Selecting the appropriate language code ensures that the phone displays the text in the proper language (e.g. abbreviations for days and months, and messages indicating that the phone is requesting service or indicating that service is unavailable).

Table 9-12 Country codes

Code	Country Name ^{ab}
1	United States of America
2	Canada
3	France
4	Italy
5	Germany
6	Spain
7	United Kingdom
8	Australia
9	Hong Kong
10	Malaysia
11	Singapore
12	Brazil
13	Netherlands
14	New Zealand
15	Portugal
16	Ireland
17	Belgium

- Check with your system administrator or ShoreTel representative to determine the level of support for a selected country.
- Please refer to the matrix on page A-9 for availability of hardware in your country.

Table 9-13 Language codes

Code	Language (Country)
1	English (US)
2	Spanish (Spain)
3	German
4	English (UK)
5	French
6	Dutch
7	Spanish (Castilian)

Step 9 Connect the Ethernet cable into the data jack on the back of the IP phone.

The phone downloads the latest bootROM and firmware from the ShoreTel server and in the process, reboots several times. When the phone displays the date and time, the boot and upgrade process is complete.

Configuring Automatic VLAN Assignment via DHCP

You can configure an IP phone to automatically determine its VLAN id via DHCP. When the phone boots for the first time, it will acquire an IP address via DHCP similar to any other network device. However, the DHCP response will also specify (using a proprietary DHCP option), the VLAN id for the phone to use. Then, the phone will release the IP address originally assigned to it and will reboot. After reboot, all packets are tagged with the VLAN id specified in the original DHCP response.

NOTE This feature affects the following phones: IP110/115/210/212k/230/530/560/560g

The following phones are unaffected by this feature: AP100, IP100

The Automatic VLAN Assignment feature is not configured through ShoreWare Director. Configuration changes are performed at the DHCP server. Parameters related to Automatic VLAN Assignment (along with their supporting text) have been italicized in the procedure that follows to make them easier to spot.

To configure Automatic VLAN Assignment via DHCP on a Microsoft DHCP server:

Step 1 Open *DHCP Manager* on your Microsoft DHCP server.

Step 2 Right-click the *DHCP server* and select *Set pre-defined options*.

Step 3 Click *Add*.

Step 4 Set *Name* to *IP Phone Boot Server*.

Step 5 Set *Data Type* to *String*.

- Step 6** Set **Code** to 156 and add a description, if desired.
- Step 7** Navigate to the **scope** options and add option 156.
- Step 8** Set the value of option 156 to: `ftpservers=ip address, Layer2Tagging=N, VlanId=X`

FtpServers always needs to be set to a ShoreWare server and is a pre-existing parameter.

Layer2Tagging is a new parameter.

- Purpose: enable/disable 802.1Q, default is disabled
- Format: `Layer2Tagging=N`

where N=0 is disable, N=1 is enable

VlanId is a new parameter.

- Purpose: VLAN id when 802.1Q is enabled, default is zero
- Format: `VlanId=X`

where X is a VLAN id between 0 and 4094

E.g., the following would enable VLAN tagging using a VLAN id of 10:

`FtpServers=192.168.0.13,Layer2Tagging=1,VlanId=10`

Time Services

When IP phones are used, time services must be available to maintain the telephone's date and time display. This requires a server that supports the Simple Network Time Protocol (SNTP).

If you do not run an NTP server within your organization, you may use one of the publicly accessible time servers used by the NIST Internet Time Service (ITS), shown in Table 9-14 below.¹

In addition, you must configure your DHCP server to provide the correct GMT offset to the IP phones at each site. See "GMT Offset" on page 15-5 for more information.

Table 9-14 NTP Time Servers

Name	IP Address	Location
time-a.nist.gov	129.6.15.28	NIST, Gaithersburg, Maryland
time-b.nist.gov	129.6.15.29	NIST, Gaithersburg, Maryland
time-a.timefreq.bldrdoc.gov	132.163.4.101	NIST, Boulder, Colorado
time-b.timefreq.bldrdoc.gov	132.163.4.102	NIST, Boulder, Colorado
time-c.timefreq.bldrdoc.gov	132.163.4.103	NIST, Boulder, Colorado

1. This list was obtained at <http://www.boulder.nist.gov/timefreq/service/time-servers.html>

Table 9-14 NTP Time Servers

Name	IP Address	Location
utcnist.colorado.edu	128.138.140.44	University of Colorado, Boulder
time.nist.gov	192.43.244.18	NCAR, Boulder, Colorado
time-nw.nist.gov	131.107.1.10	Microsoft, Redmond, Washington
nist1.symmetricom.com	69.25.96.13	Symmetricom, San Jose, California
nist1-dc.glassey.com	216.200.93.8	Abovenet, Virginia
nist1-ny.glassey.com	208.184.49.9	Abovenet, New York City
nist1-sj.glassey.com	207.126.98.204	Abovenet, San Jose, California
nist1.aol-ca.truetime.com	207.200.81.113	TrueTime, AOL facility, Sunnyvale, California
nist1.aol-va.truetime.com	64.236.96.53	TrueTime, AOL facility, Virginia

Virtual Private Network (VPN)

With the increasing desire to leverage the public Internet, and the concern about security, IP VPNs (Internet Protocol Virtual Private Networks) are becoming the secure access of choice. IP VPNs establish secure communications between employees, branches, or partners by using strong IP-based encryption and authentication techniques for transport security over the public Internet.

IP VPNs are typically viewed as falling into three major categories: remote access VPNs, intranets (company site-to-site), and extranets (business-to-business). These services are being adopted by companies of all sizes as a result of the powerful combination of high-speed access links and public networks. An example is the use of high-speed, low-cost broadband DSL connectivity to enable teleworkers or branch offices to link securely with the company network via the Internet, as if they were accessing the LAN

at the office including all network applications. A sample VPN configuration is shown in Figure 9-1.

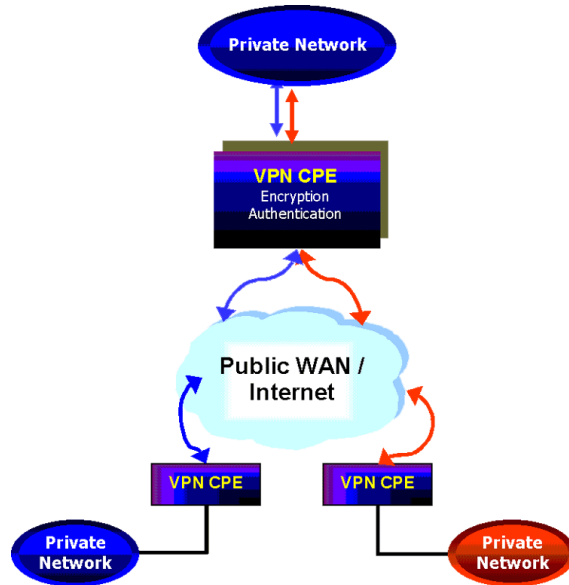

Figure 9-1 VPN Topology

IP VPNs can be provided via hardware or software solutions located at the remote facility (branch office or teleworker's home) and the customer premises. These devices or solutions use technologies such as tunneling, encryption, and authentication to guarantee secure communications across a public infrastructure.

All the components of your ShoreTel 7.5 system must exist in the same enterprise private network. VPNs can be used to bridge your private networks across the Internet so that the networks for two buildings are both part of the same private network. For multiple locations that share a private network, bandwidth calculations should include the effective bandwidth inside the private network, rather than the raw bandwidth.

Tunneling

Tunneling encapsulates one type of data packet into the packet of another protocol. Multiple tunneling protocols are used today on the market:

- **PPTP (Point-to-Point Tunneling Protocol):** PPTP includes compression and encryption techniques. This protocol was introduced by Microsoft to support secure dial-up access for its desktop, which corresponds to a large share of the desktop market.
- **L2F (Layer 2 Forwarding):** Introduced by Cisco Systems, L2F was primarily used to tunnel traffic between two Cisco routers. It also allows IPX traffic to tunnel over an IP WAN.
- **L2TP (Layer 2 Tunneling Protocol):** L2TP is an extension the PPP (Point-to-Point Protocol) that merges the best features of L2F and PPTP. L2TP is an emerging IETF (Internet Engineering Task Force) standard.
- **IPSEC:** This is a collection of security protocols from the Security Working Group of the IETF. It provides ESP (Encapsulating Security Payload), AH (Authentication Header), and IKE (Key Exchange Protocol) support. This protocol, mature but still technically in a draft format, is currently considered the standard for encryption and tunneling support in VPNs.

For PPTP, IP VPN tunneling adds another dimension to the tunneling. Before encapsulation takes place, the packets are encrypted so that the data is unreadable to outsiders. Once the encapsulated packets reach their destination, the encapsulation headers are separated, and packets are decrypted and returned to their original format.

The L2TP tunneling protocol does not encrypt before encapsulation. It requires the IPSEC protocol to take the encapsulated packet and encrypt it before sending it over the Internet.

Encryption

See “Media Encryption” on page 9-29 for more information about ShoreTel’s proprietary media encryption methods.

Encryption is the marking, transforming, and reformatting of messages to protect them from disclosure and maintain confidentiality. The two main considerations with encryption are the algorithm, such as Triple Pass DES (112 bits), RCA (128 bits), and Triple DES (168 bits), and the management of the distribution of encryption keys (IKE and PKI). These more recent keys, which support more than 100 bits, have been a major driver in the success of IP VPNs. They make it extremely difficult to hack into enterprise computer systems without an investment of millions of dollars in equipment.

Encryption starts with a key exchange that must be conducted securely. The IKE (ISAKMP/Oakley) protocol has been considered the most robust and secure key exchange protocol in the industry to date. It is also a de facto standard for service providers and product vendors requiring the highest level of security for their VPN solutions. PKI (Public Key Infrastructure), new to the key management scene, is currently thought to be the long-term solution to simplifying the management of VPNs. The industry is still evaluating and testing PKI, with some initial deployments beginning to occur.

Performance

From an IP VPN¹ performance perspective, encryption can be a CPU-intensive operation. As a result, enterprises must evaluate VPN products in two primary areas as they relate to encryption. The first is whether the maximum throughput decreases substantially when encryption is used, and the second is whether a consistent throughput can be maintained when encryption is enabled. Typically, the trade-off between performance and price is debated from a software-based versus hardware-based encryption perspective.

Integrated Security Appliances

A number of major vendors provide integrated broadband security appliances to eliminate security concerns. These devices use custom ASICs to deliver wire-speed firewall, Triple DES IPsec VPN, and traffic shaping in an easy-to-deploy, cost-effective solution. Installing a security appliance, such as a NetScreen-5, eliminates the need to deal with complex PC software installations and allows IT to centrally manage the security policies of these remote offices and teleworkers. The firewall protection secures sensitive data at the remote site and can prevent both U-turn attacks and the launching of denial-of-service attacks from these computers. By combining broadband

1. Note that Internet VPNs, though useful for data, may not offer sufficient protection against latency and packet loss for VoIP.

access technologies with an integrated security appliance, enterprises and service providers can safely and securely capitalize on all of the benefits of the broadband Internet.

Firewalls

A firewall is the first major purchase and the foundation of network security (Figure 9-2). It prevents unauthorized access to the network or web site by examining both incoming and outgoing traffic. Based on the predefined security policies, each individual packet is inspected and processed. Any type of traffic that is deemed to be “illegal” (based on rules that specify protocol type, source or destination IP address, and so on) is not allowed through the firewall. Using this tool, administrators can achieve tight control over the activities they allow into and out of their corporate network or e-business site. In a corporate network, a firewall prevents intruders from accessing corporate resources while allowing employees Internet access. In an e-business site, it allows outside access to the web server while preventing unauthorized access or attacks.

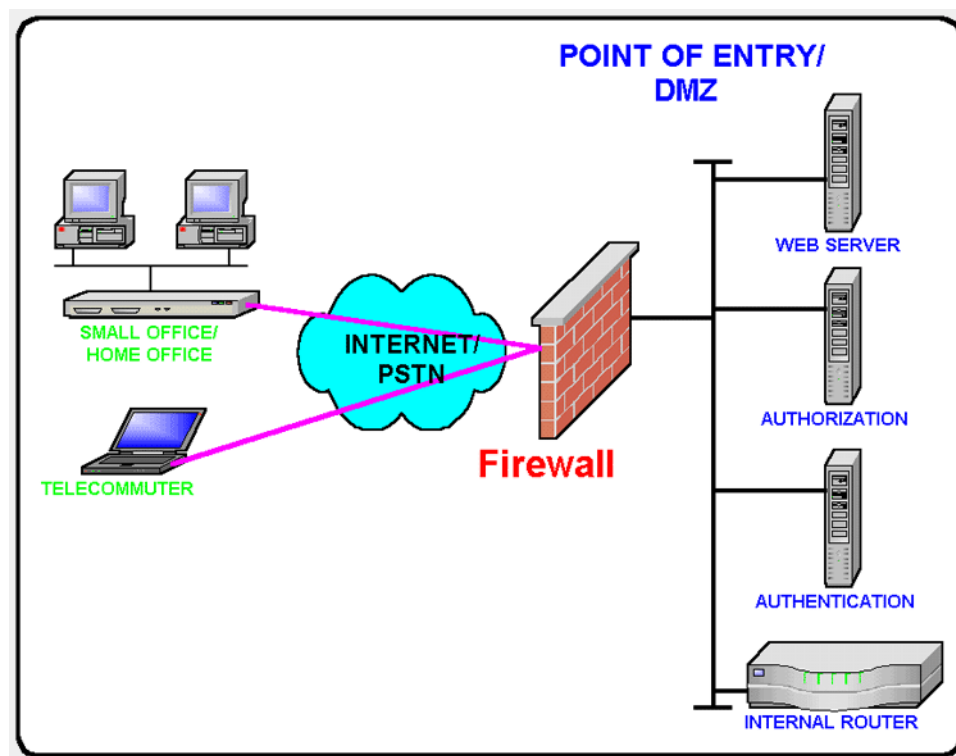

Figure 9-2 Firewalls

Often, a typical network access point, called a DMZ (demilitarized zone), is implemented to offer an “outside” presence for e-commerce clients, e-business partners, and web surfers. The DMZ acts as the gateway through which all Internet communications with the company or site transpire. It allows for controlled access to front-end web servers while protecting mission-critical resources (databases, routers, servers, and so on). Thus, the DMZ needs to be flexible, reliable, and available.

The firewall is often the first line of defense in this environment. Always vigilant, this device must look into all traffic for the site. As part of its duty, the firewall recognizes

and deals with denial-of-service attacks, such as TCP SYN flood and Ping of Death. In each of these attacks, the hackers are simply attempting to overwhelm the devices that provide an Internet presence for the company.

With a TCP SYN flood, a stream of TCP SYN packets is sent to the receiving device (often the firewall). The finite memory and size of the TCP entry tables can be overrun by spurious SYN packets, preventing any real users from making a TCP connection required for HTTP communications.

An ICMP flood attack also floods a device, by streaming ICMP echo packets at a recipient destination. This flood of packets requires the device to process and respond to these pings, burning precious resources and preventing other traffic from being serviced. By examining the site's traffic patterns, advanced firewalls can apply logical rules that prevent the device from trying to keep up with the denial-of-service attack traffic. They also prevent this traffic from reaching the valuable web, application, and database servers that create your Internet presence and service your customers.

By using firewalls in conjunction with the DMZ design technique, many businesses and service providers are striving to present as much information without permitting unwanted access to the corporate resources.

One way to keep your mission-critical resources as private as possible, while still allowing for a strong Internet presence, is to use Network Address Translation (NAT). NAT offers the outside world one, or a few, IP addresses. This allows a manager to set up whatever internal IP addressing scheme may be required by corporate policies and business needs. An internal resource's IP address (source IP) is changed as it passes through the NAT function to one of the "outside" IP addresses. Thus, the external world does not know any of the enterprise's internal IP addresses. Only the NAT device presents an IP address that is known, and used by external devices. The NAT device keeps track of these conversations and performs the IP address translation as needed.

Extending the private network of the corporate LAN to remote sites via VPN is a proven method of deploying a ShoreTel 7.5 system across multiple sites. All IP telephony endpoints (such as ShoreWare server(s), ShoreGear switches, and IP telephones) should participate in the same private network, with firewalls between ShoreTel equipment and the public Internet. If needed, you can elect to open access to the ShoreWare server(s) to access ShoreWare Director via HTTP, using the same precautions you would when exposing any critical server's web services to the public network.

NOTE Configuring firewalls to function correctly with VoIP traffic is very difficult. ShoreTel does not recommend deploying ShoreTel equipment across firewalls.

Media Encryption

In addition to using a VPN or a firewall, another method of enhancing the security on your network is to enable the ShoreTel media encryption feature. Media encryption, as the name suggests, encrypts calls between users on a ShoreTel system. The encryption scrambles communications between callers so an intruder on the network cannot eavesdrop on the conversation.

The ShoreTel encryption algorithm utilizes dynamically generated keys to encrypt the RTP data for the media stream. The payload inside the RTP packets is encrypted by the sending party, and the transmission is decrypted by the receiving party. The ShoreTel algorithm was selected due to its reliability, simplicity and its efficiency – it places very little burden on the switch's CPU even during maximum loads.

Details:

- TCP/IP and UDP packet headers are not encrypted.
- Only calls inside a ShoreTel network will be encrypted. Once the call passes through TDM or analog trunks or via SIP, the encryption is stripped away and the conversation is no longer encrypted.
- The encryption algorithm handles the key exchange between the sending and receiving parties at the time of call setup. If the call starts off without encryption, and encryption is enabled during the middle of a call, the call will remain unencrypted.
- There is no difference in the user experience for encrypted and unencrypted calls. Encryption is essentially transparent, and the user will not know if the call is being encrypted or not.
- Encryption is not supported on the SoftSwitch, so calls to voice mail or auto attendant are not encrypted.

Supported Platforms

The media encryption feature is supported on the following hardware.

Table 9-15 Platforms Supporting Media Encryption

Platform Type	Model
Switches	• ShoreGear 120/24
	• ShoreGear 90
	• ShoreGear 60/12
	• ShoreGear 50
	• ShoreGear 40/8
	• ShoreGear 220T1
	• ShoreGear 220E1
	• ShoreGear T1
	• ShoreGear E1
	IP Phones
• IP115	
• IP210	

Table 9-15 Platforms Supporting Media Encryption

Platform Type	Model
	• IP212k
	• IP230
	• IP530
	• IP560
	• IP560g

Note: Encryption is not supported on legacy ShoreTel switches or on the IP 100.

For instructions on enabling media encryption, refer to the section on Call Control Options in the *ShoreTel 7.5 Administration Guide*.

Session Initiation Protocol (SIP)

There are no special network requirements necessary for deploying SIP. The general system requirements should prove adequate for SIP support. With that in mind, please note the following:

- SIP devices are supported behind NAT(Network Address Translation) as long as they are configured statically.
- To communicate with a SIP device or service provider providing IP trunks over the Internet, you must be able to pass SIP traffic through your firewall. This requires a SIP application layer gateway – a feature provided by some firewall vendors.
- SIP signaling uses UDP port 5060.
- When using SIP, the RTP port for the voice media stream is dynamic and the SIP endpoints may not always use the same ports to exchange information (in contrast with ShoreTel's proprietary protocol, which always uses port 5004). Thus, if you are using SIP, you must deselect the “Always Use Port 5004 for RTP” check box on the Call Control Options page in Director so that it is not fixed at 5004.

Example Network Topologies

Single-Site Implementation

Figure 9-3 is an example of a simple, single-site implementation.

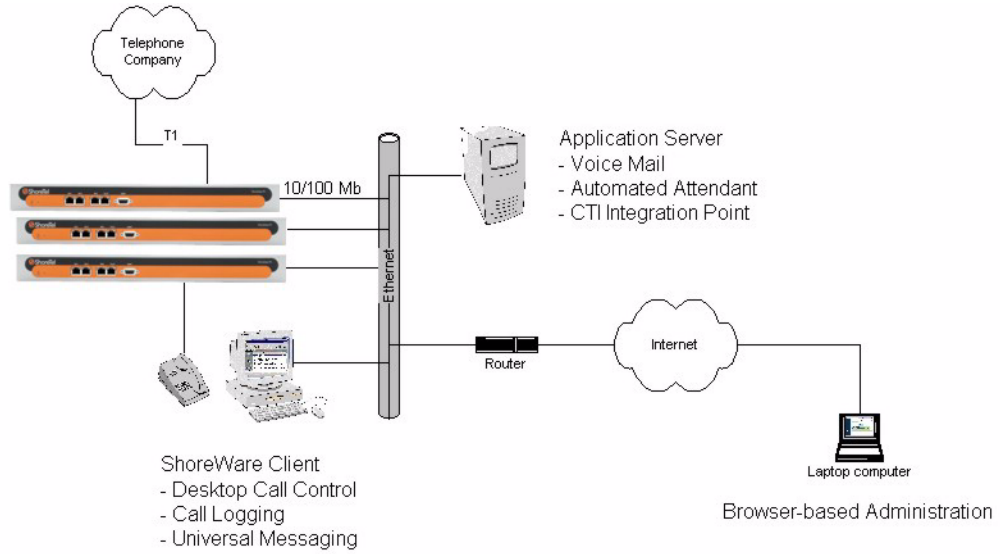

Figure 9-3 Single Site

Multisite Implementation

Figure 9-4 is an example of a multisite implementation with various WAN technology choices.

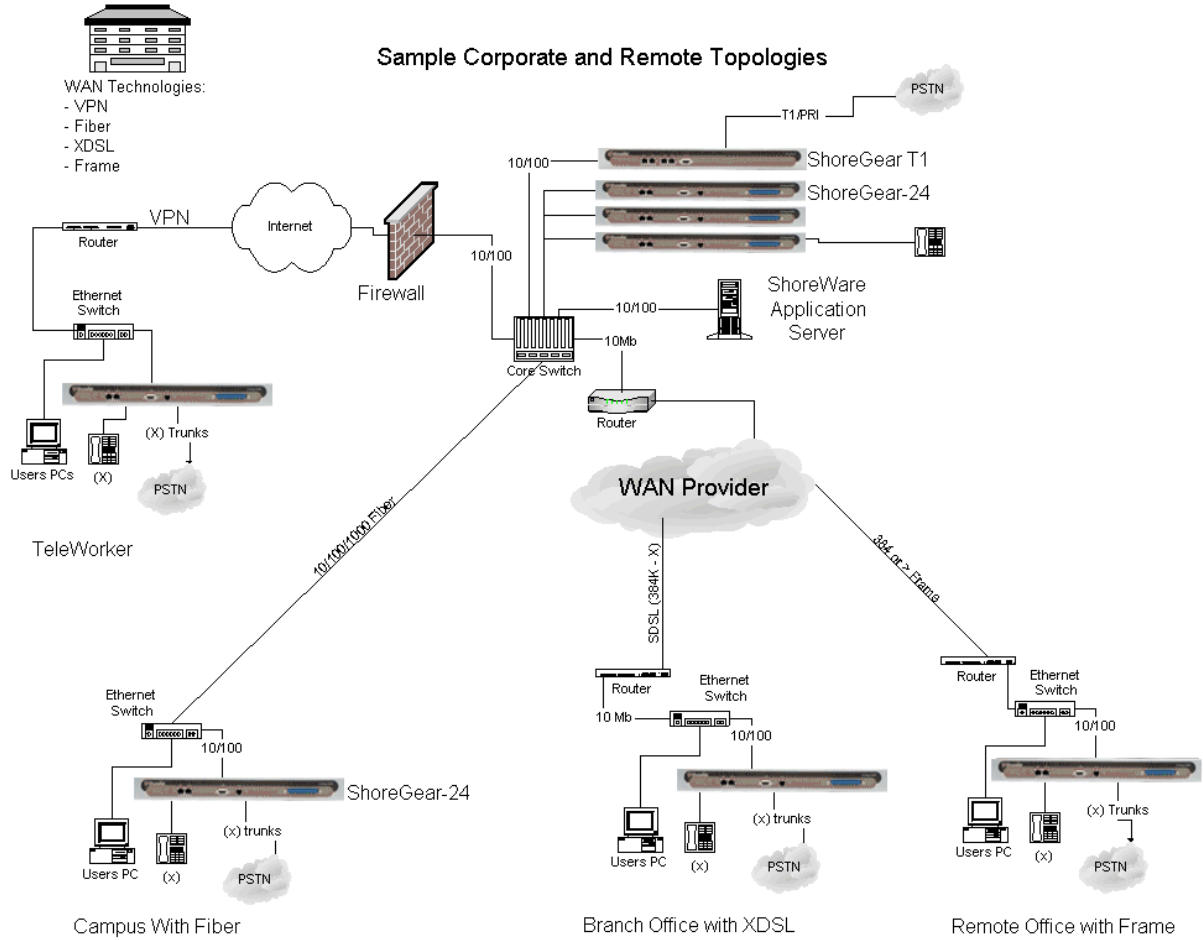

Figure 9-4 MultiSite Options

Computing Admission Control Bandwidth

This section discusses how to compute the admission control bandwidth for the site you are configuring on the **Site** edit page—that is, the appropriate value for the **Admission Control Bandwidth** parameter. If you want to determine the admission control bandwidth for your site and the information is not available in this section, use one of the following formulas:

- To determine the admission control bandwidth:

$$\text{Bandwidth} = (\# \text{ of calls}) \times (\text{bandwidth/call})$$

- To determine the number of calls supported with a specific admission control bandwidth value:

$$\# \text{ of calls} = (\text{admission control bandwidth}) / (\text{bandwidth/call})$$

ShoreTel 7.5 automatically negotiates the proper voice encoder at call setup. For calls between sites, the call control software requests the voice encoder based on what is selected for inter-site voice encoding as defined on the **Call Control Options** edit page. The call control software will then make sure both endpoints on the call can support the requested voice encoder.

For instance, for G.729a voice encoding to be used between two sites, the inter-site voice encoding must be set to G.729a and the ShoreGear voice switches at each end of the call must be G.729a-capable.

WAN Bandwidth per Call (Full Duplex) Without cRTP

Table 9-16 defines the bandwidth, including IP overhead, that is used for each voice call between sites when RTP Header Compression (cRTP) is not being used. The bandwidth depends on the voice encoding used. For example:

- If you want to support 10 calls between this site and all other sites, and G.729a voice encoding is used, set the admission control bandwidth to 260 Kbps. Before you enter this value, make sure the bandwidth is available at this site.
- If you set your admission control bandwidth to 768 Kbps and G.729a voice encoding is used, you can support up to 29 calls between this site and all other sites.

NOTE ShoreTel recommends that you configure the admission control bandwidth to be less than the bandwidth of the actual WAN link. This provides sufficient bandwidth for call control signaling and other data traffic.

Table 9-16 Bandwidth Without cRTP

Bandwidth in Kbps per Number of Calls	Linear	G.711	ADPCM	G.729a
1	146	82	52	26
2	292	170	104	52
3	438	255	156	78
4	584	340	208	104
5	730	425	260	130
6	876	510	312	156
7	1022	595	364	182

Table 9-16 Bandwidth Without cRTP

Bandwidth in Kbps per Number of Calls	Linear	G.711	ADPCM	G.729a
8	1168	680	416	208
9	1314	765	468	234
10	1460	850	520	260
11	1606	935	572	286
12	1752	1020	624	312
13	1898	1105	676	338
14	2044	1190	728	364
15	2190	1275	780	390
16	2336	1360	832	416
17	2482	1445	884	442
18	2628	1530	936	468
19	2774	1615	988	494
20	2920	1700	1040	520
21	3066	1785	1092	546
22	3212	1870	1144	572
23	3358	1955	1196	598
24	3504	2040	1248	624
25	3650	2125	1300	650
26	3796	2210	1352	676
27	3942	2295	1404	702
28	4088	2380	1456	728
29	4234	2465	1508	754
30	4380	2550	1560	780

WAN Bandwidth per Call (Full Duplex) with cRTP

Some routers support a feature called RTP Header Compression (cRTP) that significantly reduces the amount of IP overhead associated with voice over IP. Table 9-17 defines the bandwidth used between sites when cRTP is being used. For example:

- If you want to support 10 calls between this site and all other sites, and G.729a voice encoding is used, set the admission control bandwidth to 120 Kbps. Before you enter this value, make sure the bandwidth is available at this site.
- If you set your admission control bandwidth to 256 Kbps and G.729a voice encoding is used, you can support up to 21 calls between this site and all other sites.

NOTE ShoreTel recommends that you configure the admission control bandwidth to be less than the bandwidth of the actual WAN link. This provides sufficient bandwidth for call control signaling and other data traffic.

Table 9-17 Bandwidth with cRTP

Bandwidth in Kbps per Number of Calls	Linear	G.711	ADPCM	G.729a
1	132	68	38	12
2	264	136	76	24
3	396	204	114	36
4	528	272	152	48
5	660	340	190	60
6	792	408	228	72
7	924	476	266	84
8	1056	544	304	96
9	1188	612	342	108
10	1320	680	380	120
11	1452	748	418	132
12	1584	816	456	144
13	1716	884	494	156
14	1848	952	532	168
15	1980	1020	570	180
16	2112	1088	608	192
17	2244	1156	646	204
18	2376	1224	684	216
19	2508	1292	722	228
20	2640	1360	760	240
21	2772	1428	798	252
22	2904	1496	836	264
23	3036	1564	874	276
24	3168	1632	912	288
25	3300	1700	950	300
26	3432	1768	988	312
27	3564	1836	1026	324

Table 9-17 Bandwidth with cRTP

Bandwidth in Kbps per Number of Calls	Linear	G.711	ADPCM	G.729a
28	3696	1904	1064	336
29	3828	1972	1102	348
30	3960	2040	1140	360

There are two ways to set admission control:

- Determine the expected number of simultaneous intra-site calls for a site, and multiply this number by the bandwidth required for each call for your selected inter-site encoding.

When admission control is set this way, calls routing between sites will be blocked if placing the call would exceed the number of calls supported by the configured bandwidth.

For more information about ShoreTel's Admission Control feature, see "Admission Control in the Wide Area Network" on page 9-14.

Setting Admission Control

The Admission Control Bandwidth parameters are set in the Site edit page of ShoreWare Director. For information on setting this parameter, see Chapter 3, "Configuring Sites" in the *ShoreTel 7.5 Administration Guide*.

Server Requirements

The information in this chapter helps you determine the specific hardware and software requirements for your main and distributed ShoreWare servers.

Checklist

Review the following server requirement topics before proceeding to the next chapter:

Task Description	See
<input type="checkbox"/> Hardware Requirements	page 10-2
<input type="checkbox"/> Hard Disk Space Utilization	page 10-3
<input type="checkbox"/> Software Requirements	page 10-4
<input type="checkbox"/> Additional Considerations	page 10-5

Recommendations

The following recommendations will assist you in procuring and installing your ShoreWare server:

- The ShoreWare software is shipped on a DVD, so servers must be equipped with a DVD drive to facilitate installation of the software.
- Use a dedicated server for the ShoreWare server. The ShoreWare server provides voice mail, automated attendant, workgroups, and call detail recording, as well as desktop call control services. These are all business-critical applications that should run on a dedicated server.
- ShoreTel does not support the ShoreWare server for use as a Domain Controller.
- Select a server from a reputable manufacturer. Servers from clone manufacturers are not recommended for business-critical applications.
- Make sure the server has at least 1 GB of RAM.
- Be sure to follow the exact order of steps provided later in this chapter when installing the Microsoft components on the server.

- ShoreTel does not support installation on a virtual server (such as VMware) as real-time voice applications such as voicemail may not have adequate system resources.
- Be careful how you set up Internet Information Services (IIS) security features, since it can affect product features such as:
 - Access to the ShoreWare Director web pages
 - Access to the web site for installing the ShoreWare Call Manager software
 - Ability to import greetings, prompts, and names using ShoreWare Director

Hardware Requirements

The ShoreWare software is shipped on a DVD, so servers must be equipped with a DVD drive to facilitate installation of the software.

The hardware requirements for main and distributed servers vary depending on system size and peak call load.

Additional recommended configurations are shown in the tables below.¹ Your exact needs may vary based on your configuration.

Table 10-1 Headquarters Server Recommendations

Users	Load (calls/hour)	Processor	RAM	Network	Peripherals (recommended)
100	1,000	Pentium 4 3.0 GHz	1 GB	100 Base-T	Sound card, speakers, and mic
500	5,000	Pentium 4 3.6 GHz	2 GB	100 Base-T	Sound card, speakers, and mic
1,000	10,000	Dual Xeon 2.8 GHz	2 GB	100 Base-T	Sound card, speakers, and mic
2,500	25,000	Dual Xeon 3.2 GHz	2 GB	100 Base-T	Sound card, speakers, and mic
5,000	50,000	Dual Xeon 3.6 GHz	4 GB	100 Base-T or Gigabit Ethernet	Sound card, speakers, and mic
10,000	50,000	Quad Xeon 3.0 GHz	4 GB	100 Base-T or Gigabit Ethernet	Sound card, speakers, and mic

Table 10-2 Distributed Server Recommendations

Users	Load (calls/hour)	Processor	RAM	Network	Peripherals
100	1,000	Pentium 4 3.0 GHz	1 GB	100 Base-T	N/A
500	5,000	Pentium 4 3.6 GHz	2 GB	100 Base-T	N/A
1,000	10,000	Dual Xeon 2.8 GHz	2 GB	Dual 100 Base-T	N/A

For high performance and reliability, ShoreTel recommends that the main and distributed servers' disk subsystem use a caching SCSI controller configured for RAID-5.

1. Existing customers can upgrade to ShoreTel 7.5 without requiring a hardware upgrade.

Hard Disk Space Utilization

Approximately 1600 MB of hard disk space is used on the server for program software. Additional hard disk space is used for voice mail, call detail records (main server only), and log files.

Table 10-3 Hard Disk Space Requirements

Type	Space Required
ShoreWare Server	1600 MB
ShoreWare Remote Server	800 MB
ShoreWare Client	600 MB ^a

a. This amount may be necessary when installing off the network due to the installer also being copied.

Voice Mail

Each user's voice mail messages are stored on his or her respective server. The hard disk space used on each server for voice mail varies depending on the number of users, the number of messages per user, and the duration of each message.

You need approximately 30 MB of hard disk space per hour for voice mail storage.

Table 10-4 provides some conservative guidelines to estimate the amount of hard disk space used for voice mail, assuming each user has 15 one-minute voice messages.

Table 10-4 Voice Mail Hard Disk Space

# Users	# Messages	Length (minutes)	Storage (hours)	Storage (GB)
100	15	1	25	0.8 GB
500	15	1	125	3.8 GB
1,000	15	1	250	7.5 GB
2,000	15	1	500	15.0 GB
3,000	15	1	750	22.5 GB
4,000	15	1	1,000	30.0 GB
5,000	15	1	1,250	37.5 GB

Call Detail Records

For each call on the ShoreTel 7.5 system, call detail records are generated on the main server. The hard disk space used on the server for call detail records varies depending on the call load on the system. The amount of hard disk space for a typical system is shown in Table 10-5.

Table 10-5 Call Detail Records

# Calls/Day	# Calls/Month (20 days ^a)	Storage/Month	Storage/ 3 Months
100	2,000	3 MB	9 MB
1,000	20,000	30 MB	90 MB
10,000	200,000	300 MB	900 MB
50,000	100,0000	1,500 MB	4,500 MB

a. 20 working days per month (i.e. 4 weeks/month * 5 days/week = 20)

Log Files

Log files are generated on the ShoreTel 7.5 system for the purposes of technical support. The hard disk space used on the server for log files varies greatly, depending on the overall system activity.

The size of the log files on the server is controlled by parameters within ShoreWare Director. Log files are stored between 1 and 30 days (default 7 days) with a size limit between 0.5 GB and 5 GB (default 4 GB).

Table 10-6 Log File Hard Disk Space

File Size	Storage (GB)
Minimum	0.5 GB
Default	4.0 GB
Maximum	30.0 GB

Software Requirements

This version of ShoreTel software was tested and certified on the following platforms:

ShoreWare Main and Distributed Servers:

- Windows Server 2003 (Enterprise or Standard Editions only) with and without SP1 and SP2 (Web Edition is *not* supported)
- Windows Server 2003 Release 2
- Internet Explorer 6.0 + SP1
- Internet Explorer 7

NOTE All operating systems are for 32-bit. There is no support for 64-bit in this release.

Additional Considerations

Terminal Services

With Windows Server 2003, Microsoft has included the ability to remotely access a server with Remote Administration. In Windows 2003, set up Remote Administration by right-clicking My Computer and then clicking the Remote tab.

Remote Administration allows you to remotely administer a server across the network. In particular, this allows you to launch a terminal session against the main and distributed servers for the purposes of software installation.

NOTE ShoreTel 7.5 also supports Citrix and Terminal Services for ShoreTel client applications. For more information, see Appendix F, “ShoreWare Clients on Citrix and Windows Terminal Servers.”

Adobe Acrobat Reader

Install Adobe Acrobat Reader on the server if you do not already have it, so that you can access the online documentation. You can install Adobe Acrobat Reader from the ShoreWare DVD Browser or download it from the Adobe web site.

DHCP on the ShoreWare Server

ShoreTel does not recommend that the ShoreWare server be used as a Dynamic Host Configuration Protocol (DHCP) server. If you want to use the ShoreWare server to give out IP addresses to the ShoreGear voice switches, you should use the BOOTP server included within ShoreWare Director.

Server Computer Name

You cannot change the computer name of the ShoreWare server after installation. The ShoreWare server software uses Microsoft Transaction Server (MTS), whose license package relies on the name of the computer. Not only will the ShoreWare server not start properly, but you will break the package security if you change the name of the computer.

Server IP Address

The ShoreWare server should have a static IP address to eliminate the possibility that the server will inadvertently get a new IP address, thus adversely affecting system operation.

Internet Information Server (IIS) Default Web Site

The web site for ShoreWare Director is <server_name>/ShoreWareDirector. You should not change the default IIS web site of the server to redirect to ShoreWare Director, since this will cause navigation problems within ShoreWare Director.

Access to the Distributed Server Maintenance Page

If you are using Microsoft Internet Explorer 6 and the distributed server is configured with an IP address rather than a server name, you must enable session cookies on your client computer to access the Distributed Server Maintenance Page.

In Internet Explorer, choose **Tools > Options > Privacy tab > Advanced > Override automatic cookies — Always allow session cookies**.

C H A P T E R 1 1

Planning Applications and Services

This chapter reviews the key applications and services of the ShoreTel 7.5 system to assist you in planning your system configuration, and to determine the equipment you need for completing deployment.

Checklist

Review the following application planning topics before proceeding to the next chapter:

Task Description	See
<input type="checkbox"/> Account Code Collection Service	page 11-2
<input type="checkbox"/> Voice Mail	page 11-3
<input type="checkbox"/> Planning Fax Handling	page 11-4
<input type="checkbox"/> Private Numbers	page 11-17
<input type="checkbox"/> Automated Attendant	page 11-18
<input type="checkbox"/> Call Handling Delegation	page 11-18
<input type="checkbox"/> Web Access	page 11-19
<input type="checkbox"/> Bridged Call Appearances	page 11-19
<input type="checkbox"/> Hunt Groups	page 11-20
<input type="checkbox"/> Pickup Groups	page 11-22
<input type="checkbox"/> Workgroups	page 11-24
<input type="checkbox"/> ShoreWare Call Manager	page 11-26
<input type="checkbox"/> SoftPhone	page 11-27
<input type="checkbox"/> Enterprise Telephony Features	page 11-28
<input type="checkbox"/> ShoreTel Conference Bridge	page 11-31
<input type="checkbox"/> ShoreTel Contact Center Solution	page 11-33

Account Code Collection Service

ShoreTel 7.5 supports account codes for external calls when you enable the Account Code Collection Service. When a user dials a number that is not included in the scope of his or her call permissions, the call is routed to the Account Code Collection Service extension, where the user is prompted to enter a valid account code. Account code collection is enabled on a per-user group basis and can be set to be one of three states: disabled, optional, or forced. The Account Code Collection Service is associated with a configurable extension and has a dedicated user group that defines ultimate call permissions and trunk group access.

A new user group is created during installation for use by the Account Code Collection Service. This user group is named “Account Codes Service.” Since it is only intended for use by the Account Code Collection Service, this group does not appear in drop-down lists for the assignment of User Groups to users and other objects such as workgroups. You can, however, change all attributes of the Account Codes Service User Group except the fields indicating whether Account Codes are disabled, optional, or required.

The Account Code Collection Service is associated with a system extension that is hosted on the SoftSwitch running on the headquarters (HQ) server only. If the HQ SoftSwitch is not reachable by the originating ShoreGear switch, the call is handled according to the setting on the caller’s user group. Specifically, during such a connectivity outage, calls placed by users who have optional account code collection are automatically placed, and calls placed by users who have forced account code collection are automatically rejected.

Account Codes

Account Code Collection Service supports up to 50,000 account codes of a maximum of 20 characters. You can include non-numeric characters (such as hyphens and slashes) in the account codes; however, non-numeric characters are not used in account code collection or in the account code reports. An account code can be the same as a prefix for another account code. For example, the account codes 1234 and 12345 can coexist.

The following table gives example account codes and how the Account Code Collection Service interprets the code.

Sample Account Code	Recorded Code
Sales 200	200
1001-3	10013
1.234A	1234
3000 Exec 2	30002

Account codes can also have user-friendly names of up to 50 characters.

Call Permissions

The call permissions define what dialed numbers are directed to the Account Codes Service for user groups configured with account codes. For calls that are redirected to the account codes extension, the call is completed with the trunk access and call permissions of the Account Codes Service.

This structure imposes two sets of permissions on outbound calls:

- The call permissions for the user group of the user who places the call are used to determine if an account code must be collected or not.
- The call permissions for the Account Codes Service determine whether calls are finally placed, or if the intercept tone is to be played.

Voice Mail

The ShoreTel 7.5 system provides voice mail for all users and workgroups on the system. The system supports up to 21 application servers—one main server and up to 20 distributed servers. Any of the servers can host the voice mail application.

You should provision a distributed server at any site with more than 100 users to effectively manage your WAN bandwidth between that site and the headquarters or main site. In addition, you must add a distributed server with the voice mail application at any site where the required number of mailboxes exceeds 1,000.

Users should be configured for the server that is located at their home or most frequent site. If that site does not have a server, the nearest server or headquarters server should be used.

NOTE When there are multiple voice mail servers, the system-wide voice mail extension automatically maps to the extension of the local voice mail server. Voice mail media streams are therefore recorded in the CDR reports by the voice mail extension that actually handles the call.

The ShoreTel 7.5 system provides each user with five call handling modes, and workgroups with four call handling modes, allowing employees and workgroups to customize how calls are routed. Employees typically use Standard call handling mode to route calls to voice mail after three or four rings, and use Out of the Office call handling mode to route calls directly to voice mail.

Users should consider:

- Forwarding calls to a cell phone
- Forwarding calls to an external answering service (for critical users or workgroups)

NOTE You must enable external call handling as part of the class of service for users who want to use these options.

The Message Notification feature of the ShoreTel 7.5 system allows users to be notified when they receive a message. Notifications can be sent upon receipt of all messages, or only upon receipt of urgent messages. Notifications can be sent to:

- An E-mail address (with or without the voice mail attached as a .wav file)
- A pager (which allows message notification)
- An extension (which allows message playback)
- An external number, such as a cell phone (which allows message playback)
- Users who address and compose voice mail through the Telephone User Interface (TUI), the Visual Voicemail application, or the Outlook Voicemail form can now mark composed messages for a “return receipt.”

Escalation Notifications

Similarly, the ShoreTel system can send any of these notifications types to specific members of an escalation profile, in support of an Escalation Notification feature. The Escalation Notifications feature is a traditional voice mail feature that allows support groups to offer round-the-clock service to their customers, such that when a customer calls into the ShoreTel system and leaves a message, the voice mail system sends out a page, phone call, or email to a designated employee in the support department. If this first employee ignores his beeping pager, the next designated employee within the escalation profile list is contacted, and so on. Employees in the escalation profile will continue to be contacted sequentially until someone listens to the voice mail. (See “Configuring Users” in the *ShoreTel 7.5 Administration Guide* for more information on this feature.)

Auto-deletion of Voice Mail Messages

The ShoreTel system also supports the ability to automatically delete user voicemail messages that are older than a specified time limit. The system administrator can set a maximum time limit for the storage of voice mail messages, and if this time limit is exceeded, messages are automatically deleted. The tool can be used to encourage users to better manage their voice mailboxes.

Mailbox Full Notifications

The ShoreTel system can be configured to notify users when their voice mailboxes are almost full. This feature warns users of the impending lack of storage space to give them ample time to delete messages, as opposed to logging into their voice mailbox only to discover that the mailbox is full. Once a user's mailbox has passed a threshold, the system sends a notice informing them that their mailbox is almost full and that there is only enough room for 10 additional messages. Thusly, users are not caught off-guard by an unexpected (and unwanted) “mailbox full” notification.

For more information, see the “Configuring Users” chapter in the *ShoreTel 7.5 Administration Guide*.

Distributed Voice Mail

ShoreTel 7.5 has Distributed Voice Mail to provide greater availability. Each ShoreWare Remote Server has an instance of the telephony platform, allowing full functionality of voice mail and auto-attendant services at that location during WAN outages. The Distributed Voice Mail feature allows users with mailboxes on that server to receive and pickup voice mail messages without having to depend on a WAN connection to the headquarters server that hosts the configuration database. The message waiting indicator (MWI) lights correctly update local users about voice mail with or without WAN connectivity.

Additionally, incoming calls reach the auto-attendant, access the dial-by-name directory, and reach their intended local party during a WAN outage. If a party cannot be reached directly and his call handling setting would send unanswered calls to voice mail, the call is handled by the local voice mail server. If the user's voice mailbox resides on a different voice mail server, the local ShoreTel server will accept, store and forward the message when connectivity to the proper voice mail server is restarted. The caller hears a generic greeting including the intended party's recorded name and the caller has the option to leave a message. This message will be forwarded at a later time to the home voice mail server for the addressee via SMTP.

Although each voice mail server is autonomous in delivering voice services, it must have connectivity to the headquarters server in order to carry out configuration changes. Specifically, users on an isolated remote server are not able to change call handling modes or make other changes that require modification to the configuration database on the headquarters server.

The Call Manager applications may provide limited call control access and may not display some contents on IP phones at a remote site during WAN outages. These both require connectivity to the headquarters server for full service. For users who have their Call Manager application running at the time of a WAN outage, graphical access to their voice mail box is provided, including the ability to compose and playback messages, but Call Manager may not display the corresponding call activity associated with any actions.

The enhanced Distributed Voice Mail services bring a new level of availability to existing remote servers and allow additional deployment of remote servers up to a system total of 20 remote servers.

AMIS Protocol Support

The ShoreTel 7.5 system can send and receive voice mail messages to and from legacy voice mail systems using the AMIS protocol Version 1 - Specification; February 1992. To send voice mail messages to remote AMIS sites, ShoreTel 7.5 dials the access phone number for the remote system. Likewise, to receive voice messages from a remote system, the remote system must know the number to dial into the ShoreTel 7.5 system. To reach the ShoreTel 7.5 system, the remote system must be configured to dial any number that reaches an auto-attendant menu.

AMIS call support is enabled by default. Incoming AMIS voice mail is delivered in the same manner as other voice mail; however, replies cannot be sent. To send outbound AMIS voice mail, you must create AMIS systems in ShoreWare Director.

ShoreTel 7.5 negotiates the setup, handshaking, and teardown of AMIS system calls. Each voice mail requires a call over the AMIS delivery and call-back numbers.

To simplify AMIS systems, and increase usability:

- Use the same extension length across your enterprise.
- Use off system extensions to match remote users' mail boxes with their extension numbers.
- To identify the remote site location, assign each system a System ID.

For more information on AMIS systems, see the *ShoreTel 7.5 Administration Guide*.

SMDI Protocol Support

The ShoreTel 7.5 system supports the SMDI protocol. Two modes of operation are supported:

- In the first mode of operation, the ShoreTel system acts as a PBX for a legacy voice mail system. The ShoreTel 7.5 system provides call information for forwarded or direct calls to the legacy voice mail system, and receives incoming message waiting indication from the legacy voice mail system.
- In the second mode of operation, the ShoreTel system acts as the voice mail system for a number of users on a legacy PBX.

Both configurations require a serial link between a ShoreTel server and the legacy voice mail system, as this is the medium required by the SMDI protocol.

If using the first mode mentioned above, a group of analog trunks must be used to connect the ShoreTel system to the legacy voice mail system (the ShoreTel system is on the extension side of the trunks). The ShoreTel voice mail application manages the group of outgoing extensions. The ShoreTel server can provide digit translation if the legacy voice mail and ShoreTel system have different extension lengths.

It is possible to have some ShoreTel users on the ShoreTel voice mail and some on the legacy voice mail. However, these users will not be able to send messages to each other unless AMIS is implemented between the two systems. Voice mailboxes for workgroups and agents must be on the ShoreTel voice mail system.

The Personal Call Manager (PCM) operates the same way it does when a user has no mailbox:

- Voice mail viewer is not available
- Windows Control Panel does not contain Voice Mail tab
- Find Me and Notification features are not available
- Dial Mailbox and Transfer to Mailbox are not available for this user from other user's clients
- To Voice Mail button on PCM transfers the call to the system voice mail extension

For more information about using a serial link and SMDI protocol to integrate the ShoreTel 7.5 system with a legacy voice mail system, see Chapter 14, "Legacy Integration."

Find Me Call Handling

Find Me and Auto Find Me¹ call handling allow callers to find users at other locations when they reach the user's voice mail. When Find Me is enabled for the current Call Handling Mode, inbound callers that reach a ShoreTel user's voice mail box can activate Find Me call handling by pressing "1." If the caller activates Find Me call handling, the system plays a prompt indicating that it is now finding the called party: *"Please hold while I try to find your party."*

ShoreTel users can specify two Find Me destinations, which can be internal or external numbers. These numbers can be enabled or disabled for each Call Handling Mode. If a call is forwarded to the first number and is not answered within a configurable number of rings, the call can either be forwarded to a second Find Me destination or can be returned to voice mail.

The Caller ID that appears on Find Me calls is the voice mail Caller ID and not the ID of the original caller. However, if the source of the original call is external to the system, then the Caller ID will be displayed. Personal Assistant (pressing "0") also works when Find Me forwarding is enabled. The voice mail system dials the configured Find Me numbers in sequence. When a Find Me call is answered, voice mail announces the call through a sequence of prompts.

The party that answers a Find Me call hears prompts similar to the following:

- "I have a call for Sam Smith from 4085551212."
- "To accept this call, press one."
- "To send this call to voice mail, press two."
- "To repeat the caller ID, press three."

1. Auto Find Me streamlines the existing Find Me feature by automating the call forwarding behavior. When a call enters voice mail, it is immediately sent to the Find Me destination number without requiring the caller to press 1.

The party at the Find Me number has three options for directing the call:

- Pressing 1 connects the original caller with the intended party at the Find Me destination.
- Pressing 2 directs the voice mail system to immediately start taking a message for the intended party from the original caller.
- Pressing 3 repeats the Caller ID information available on the call, if any. This also extends the timeout by 1 ring (6 seconds).

The voice mail system does not automatically notify callers of the Find Me call handling option. ShoreTel users can elect to tell callers of the Find Me option in their recorded greeting (i.e. they can tell callers to “press 1 to Find Me”). If the user does not tell callers about the Find Me option in their greeting, the Find Me option can remain a hidden capability available only to selected callers. Conversely, users can automate the Find Me behavior so that when a call enters voice mail (and Auto Find Me is enabled), the call is immediately sent to the Find Me destination numbers without requiring any action on the part of the caller.

Call Sender

Users can place a return call to the originator of a voice mail by pressing “5” from the phone during message playback. Users can also call back the voice mail sender from Call Manager, Agent Monitor, or Microsoft Outlook, if the user is so provisioned. To use this feature, the user must belong to a user group with trunk-to-trunk transfer Class of Service enabled. For more information, see the *ShoreTel 7.5 Administration Guide*.

The user has the option of replying with either a voice message or a phone call if Caller ID information is available on the call. If no Caller ID information is available for the call (for example, on calls from an outside caller), the “reply with a call” option is not available for that message.

When the user chooses to reply with a phone call, the call is transferred to the number of the originating party. When the originating party is an external caller, the message recipient must have the dialing permission to dial the Caller ID number. Once the message recipient is transferred to the number of the message originator, there is no option to return to the mailbox.

Time Stamps

The time stamp of the message is relative to the time on the server where the message is taken. For example:

- When the user views messages in the Voice Mail Viewer or Outlook Form, the user interface will adjust the time stamp based upon the time of the user’s computer.
- When the user dials into voice mail to retrieve their messages, the time stamp will be based on the time of the server.

Planning Fax Handling

The ShoreTel 7.5 system supports fax calls. There are several ways to configure your fax service.

- A direct fax number for each site
- Direct fax numbers for each user (using either individual fax machines or a fax server)
- Redirect faxes that are sent to the site's main number to a fax machine extension at the site
- Redirect faxes that are sent to a user's extension to user's local fax extension

Figure 11-1 shows how to plan your fax options.

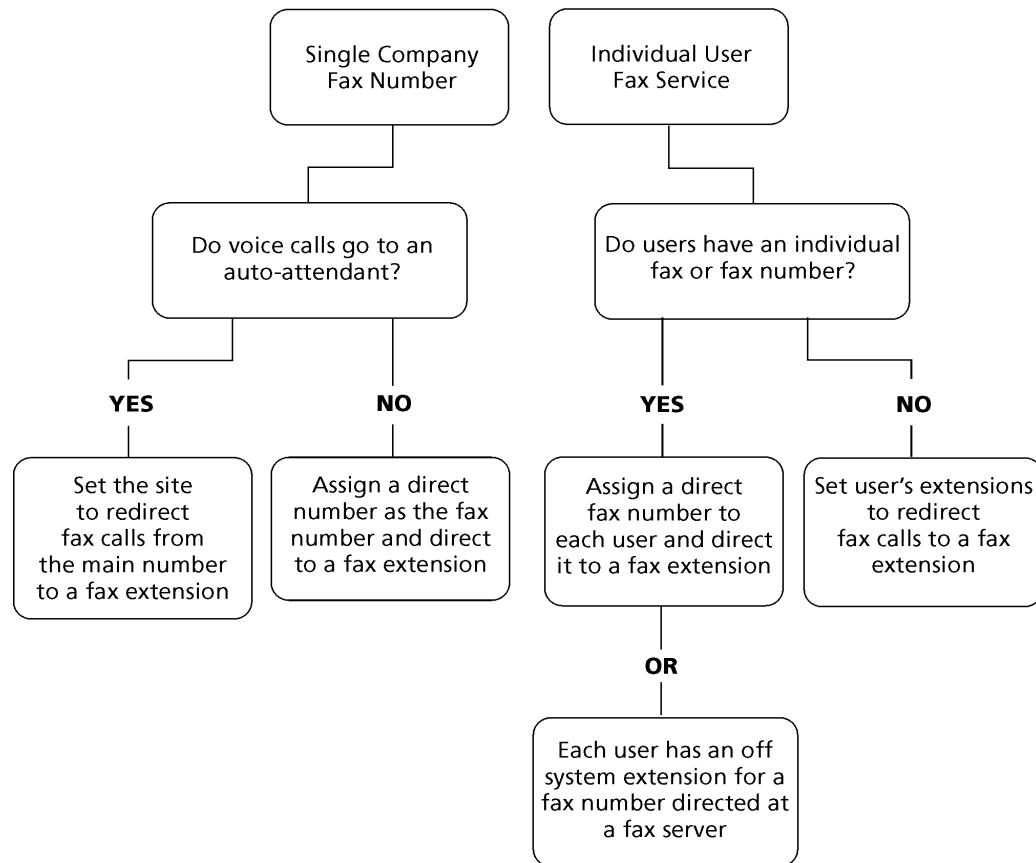

Figure 11-1 Planning fax service

How you configure your fax service with ShoreWare Director depends on which method of fax call handling you have chosen. The following provides a basic outline of the steps involved:

- If you plan to use the main number for voice and fax calls, and the main number goes to an auto-attendant:

Step 1 Configure the fax extension through the User edit page of ShoreWare Director.

NOTE Make sure that fax redirection is disabled for fax extension “users.”

Step 2 Enter a fax extension you created in Step 1 in the FAX Redirect Extension field from the Site edit page.

- If you plan to use the main number for voice and fax calls, and the main number goes to an operator:

Step 1 Configure the fax extension through the User edit page of ShoreWare Director.

Step 2 Assign a direct number as the fax number.

Step 3 From the Trunk Group edit page (on the DNIS map page), set the destination to the fax extension.

- If your users have their own faxes or fax service:

Step 1 Configure the fax extension(s) through the User edit page of ShoreWare Director.

Step 2 Assign a range of direct fax numbers.

Step 3 From the Trunk Group edit page (on the DNIS map page), set the destination for each fax number to the appropriate fax extension.

- If you plan for each user to have a single number for both voice and fax:

Step 1 Configure the fax extension(s) through the User edit page of ShoreWare Director.

Step 2 Enable fax redirection from the User edit page and enable fax redirect for the site by entering a fax extension on the site edit page.

For more information on these settings, see the *ShoreTel 7.5 Administration Guide*.

Using a Fax Server

A fax server improves services available to your users, helping them be more productive. With a fax server, users can:

- Send faxes directly from the desktop eliminating the need to print faxes to send.
- Receive faxes directly on the desktop.
- Integrate fax communications with e-mail and voice mail applications.
- Have individual fax numbers
- Maintain soft copies of all faxes for easy printing and document management.

Using a fax server with the ShoreTel 7.5 system allows you to:

- Share inbound and outbound trunks for fax services.
- Reduce toll charges by leveraging your VoIP network for outbound faxes.

For inbound fax support, users can be assigned a personal fax number from the DID range of one of the trunk groups and this DID number can be the same as the user’s regular telephone extension. When a call is received, if the fax redirect feature is enabled, the system can differentiate between voice calls and fax calls and react appropriately.

Outbound faxes are queued by the server and then sent across the IP network to the best available trunk.

ShoreTel 7.5 Fax Server Requirements

- Sufficient ports on ShoreGear-120/24 voice switches
- Sufficient ShoreWare User Licenses
- Sufficient DID trunks to support both fax and voice DID for all users

Network Requirements

The network requirements for faxing over IP are more stringent than for voice over IP. For voice communications, a 1% packet loss has negligible impact on voice quality. However, a 1% packet loss for fax communications means a loss of approximately 3 lines per fax page. ShoreTel recommends that packet loss not exceed 0.1% across the LAN and WAN when using fax servers with the ShoreTel 7.5 system.

Fax communications are also impacted by voice compression. Since fax machines typically require 19.2 Kbps, ShoreTel recommends that you use G.711 voice encoding for fax calls. For more information on fax requirements, see “Fax Machines and Modems” on page 8-3.

Note that the fax redirect feature will not work with calls that come in on SIP trunks.

Fax Server Integration Details

Instead of requiring users to have two separate DID numbers (one for voice and one for fax) a single DID line can handle voice calls and inbound/outbound faxing.

A user's extension (which can be 3, 4, or 5 digits) is sent to a fax server via in-band Dual Tone Multi Frequency (DTMF) digits. The fax server uses this information to create a mapping between the user's extension and his or her email address.

Once configured, incoming fax calls are received at the user's phone extension. The fax server listens for the fax tone, takes over the call (assuming the fax redirect radio button has been selected in Director). When the fax transmission is complete, the loop current is automatically turned off to terminate the fax call, and the fax is forwarded to the associated email address.

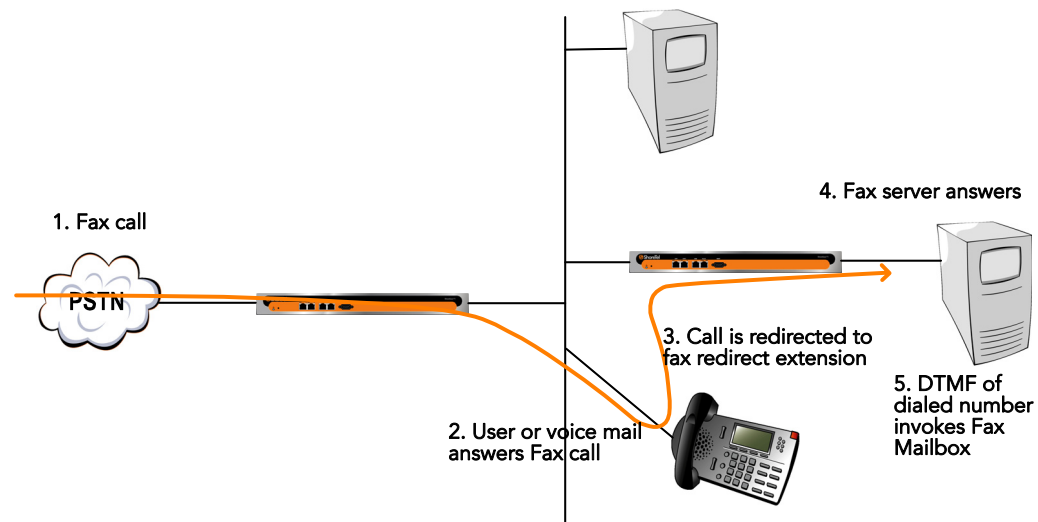

Figure 11-2 Fax server integration call flow

Enhanced FAX Server Integration

In addition to calls redirected from a user's extension, the ShoreTel system will now deliver digits to a Fax Server for DID calls routed directly to a FAX server, thus allowing the call to go directly to the fax extension and provide DID/DNIS digits, instead of to an extension number and then to the fax server.

Configuring Fax Server Integration

At a high level, the process of setting up the Fax Server Integration feature involves three tasks:

- Connecting the hardware (i.e. connecting the fax server ports to the analog ports on the switch)
- Creating a user account to represent each analog port
- Enabling the Fax Server Integration feature for each user account

To configure the Fax Server Integration feature:

- Step 1** Configure a fax server per the manufacturer's instructions.
- Step 2** Connect the fax server to one of the **analog** ports on the ShoreTel switch. The following switches support fax server integration:
 - IP PBX 24
 - ShoreGear 40/8
 - ShoreGear 50
 - ShoreGear 60/12
 - ShoreGear 90
 - ShoreGear 120/24

Next, you will create user accounts to represent each analog switch port that connects to the fax server.

- Step 3** Launch ShoreWare Director and enter the user ID and password.
- Step 4** Click on the **Administration** link to expand the list (if it has not already been expanded).
- Step 5** Click on the **Users** link and then the **Individual Users** link, and then **Add a New User**.
- Step 6** The **Edit User** window appears, as shown below. (Arrows in the illustration point to fields that must be configured. Refer to the bulleted list below the illustration for details.)

Users
Edit User

New Copy Save Delete Reset

▼ General ▶ Personal Options ▶ Distribution Lists ▶ Workgroups

First Name:

Last Name:

Number:

License Type: ←

Caller ID: (e.g. +1 (408) 331-3300)

DID:

PSTN Failover:

User Group: [Go to this User Group](#) ←

Site:

Language:

Home Port: IP Phones Ports ← SoftSwitch

Current Port:

Jack #:

Mailbox on Server: [Voice Mail Delivery and Notifications](#)

Accept Broadcast Messages ←

Include in System Dial By Name Directory ←

Make Number Private

Allow Use of Soft Phone

Fax Support:

None

Redirect Inbound Fax Calls to Site Fax Extension

This Extension Is Connected to a Fax Server ←

Figure 11-3 Creating a user account for the fax server

Step 7 Enter information for each of the fields as shown below for each field:

- License Type: Extension-Only
- User Group: You must create a User Group appropriately configured for a fax server. The User Group should have the Class of Service for Call Permissions set to **No Restrictions** to transfer inbound and outbound faxes.

- Home Port: Select the **Ports** radio button and then use the drop-down menu to select the switch where the fax server will be connected.
- Accept Broadcast Messages: Should appear grayed-out or be deselected because the port will not be assigned a mailbox.
- Include in System Dial By Name Directory: Check box may be selected if you want callers to be able to locate the fax number using the Dial by Name feature.
- Fax Support: **This Extension is Connected to a Fax Server** radio button must be selected.

Step 8 Click the **Save** button to store your changes.

Step 9 Click on the **Personal Options** tab and enter “1” in the Current call stack size field.

Step 10 Click **Save** to store your changes.

Next, you will configure the call handling mode for each of the user account(s) associated with the port(s) connected to the fax server.

Step 11 From Director, select the user account representing the fax server connection.

Step 12 Click on the **Personal Options** tab.

Step 13 Click on the **Standard** link under Edit Call Handling Modes.

Step 14 Under Call Forward Condition, select the **No Answer/Busy** radio button, as shown below:

Standard Mode [Help](#)

Fax1 Marketing * modified

[Save](#) [Reset](#)

Edit this record [Refresh this page](#)

Call Forward Condition: Always No Answer/Busy Never

Always Destination: Extension: [Search](#)
 External: (e.g. 9+1 (408) 331-3300)

Busy Destination: Extension: [Search](#)
 External: (e.g. 9+1 (408) 331-3300)

No Answer Destination: Extension: [Search](#)
 External: (e.g. 9+1 (408) 331-3300)

Figure 11-4 Configuring call handling mode for Busy/No Answer failover

Step 15 In the Busy Destination and No Answer Destination radio buttons, select **Extension** and specify the analog port where incoming fax calls will be directed if the first fax port is busy.

For example, if you have set up three ports to receive fax calls, you might configure the first port in this series to redirect to the second port, and the second port would specify the third as a failover.

Step 16 Click **Save** to store your changes.

NOTE This configuration assumes multiple analog ports will be used to connect the switch to the fax server. If only one fax server port will be used to connect to the fax server, then the call forwarding must be set to **Never**. Similarly, if this port is the last one in a chain of ports dedicated to the fax server, then the call forwarding must be set to **Never**.

If you are using multiple analog switch ports to connect to the fax server you must specify the first redirect extension in that chain. (This is the site's fax redirect extension.)

Step 17 Under the **Administration** link, click **Sites**.

Step 18 Click on the site where the switch and fax server are located (i.e. either **Headquarters** or **Remote**).

Step 19 Under **FAX Redirect Extension** (near the bottom of the Site window), enter the extension associated with the first port in the chain of fax server ports. (This is the first place incoming faxes will be sent.)

The screenshot shows the 'Sites' configuration interface. At the top, there are buttons for 'New', 'Copy', 'Save', 'Delete', and 'Reset'. Below these is a table with one row for 'Headquarters'. The 'Edit this record' link is highlighted. The configuration fields are as follows:

- Name: Headquarters
- Country: United States of America
- Language: English
- Parent: Top of Tree
- Use Parent As Proxy
- Local Area Code: 408
- Additional Local Area Codes: Edit
- Caller's Emergency Service Identification (CESID): +1 (408) 331-3300 (e.g. +1 (408) 331-3300)
- Time Zone: (GMT-08:00) Pacific Time (US & Canada); Tijuana, Pacific Standard Time
- NightBell Extension: 21567
- Night Bell Switch: HQ-Fuji (with a link to 'Edit Night Bell Call Handling')
- Paging Extension: 21678
- Paging Switch: HQ-Fuji
- Operator Extension: 22115 - Gregorio Lavilla (with a 'Search' button)
- FAX Redirect Extension: 21100 - Fax Port1 (with a 'Search' button and an arrow pointing to it)

Figure 11-5 Configuring Fax Redirect extension for primary fax server port

Step 20 Click **Save** to store your changes.

Next, you must configure settings for each user that will be using the new Fax Server Integration feature.

Step 21 Click on the Users link and then the **Individual Users** link.

Step 22 Click on the name of a user who will be using the enhanced Fax Server Integration feature.

Step 23 The Edit User window appears, similar to the one shown below.

Users
Edit User

New Copy Save Delete Reset

General Personal Options Distribution Lists Workgroups

First Name:

Last Name:

Number:

License Type:

Caller ID: (e.g. +1 (408) 331-3300)

DID:

PSTN Failover:

User Group: [Go to this User Group](#)

Site:

Language:

Home Port: IP Phones
 Ports
 SoftSwitch

Current Port:

Jack #:

Mailbox on Server: [Voice Mail Delivery and Notifications](#)

Accept Broadcast Messages

Include in System Dial By Name Directory

Make Number Private

Allow Use of Soft Phone

Fax Support:

None

Redirect Inbound Fax Calls to Site Fax Extension ←

This Extension Is Connected to a Fax Server

Figure 11-6 Enabling fax redirect for a user

Step 24 Select Redirect Inbound Fax Calls to Site Fax Extension for the Fax Support radio button.

Step 25 Click the Save button to store your changes.

Private Numbers

Users can have private numbers that are not listed in the System Directory or in Call Manager Quick Dialer, and for which Caller ID information suppressed. Private Numbers are enabled through a check box on the User edit page in ShoreWare Director. When checked, the user's extension becomes a Private Number.

The following conditions apply to private numbers:

- Private Numbers do not appear in the QuickDialer for dial-by-name operations or in the ShoreTel Directory Viewer.
- Calls placed from a Private Number to an internal party show the caller's name but not his or her number to the dialed party.
- Calls placed from a Private Number to an external party do not deliver a Direct-Inward-Dial (DID) number as Caller ID when PRI trunks are used for the outbound call. The site CESID number is used for the outbound Caller ID.
- Calls from a Private Number to an off-system extension on PRI trunks with NI2 signaling deliver calling name information but not calling number information.
- Routing slips and the Call Manager History viewer show the Private Number user's name but not his or her extension number.
- The Private Number users are listed with name and number in the Extension Monitor extension selection dialog box.
- The Private Number user can be dialed directly via the telephone or the Call Manager if his or her extension is known.
- Contacts imported from Outlook or Exchange are never private and are fully visible in the Call Manager Quick Dialer.
- CDR database records show both number and name for Private Number users. However, the Caller-ID Flags field indicates that only the name is valid.
- CDR legacy log files show the number of Private Number user calls that are inbound or outbound calls.
- ShoreWare Director shows number information for Private Number users as with other users, for example on the User list page.

Automated Attendant

The ShoreTel 7.5 system comes bundled with an automated attendant feature that runs on each of the voice application servers, allowing high availability. The system supports up to 256 menus with four scheduled modes, providing a simple, flexible solution.

Some useful applications for the auto-attendant menus are:

- Answering the main number
- Routing calls to workgroups (sales, support, human resources, and so on)
- Providing automated directions
- Providing a way for users to log in to voice mail (“#” recommended)

Although the automated attendant is a useful tool, you should take care to design a menu structure that does not frustrate your callers. Here are some helpful hints to keep in mind:

- Do not cascade menus more than two or three deep.
- Provide a “zero-out” option on every menu, routing the call to a live human being (“0” is recommended).
- Remember to provide an option to return to the previous menu (“*” is recommended).
- Try to keep prompts short, quick, and efficient.

NOTE Users can record AA menu prompts from their own telephone, instead of having to go through Director. This ability frees the system administrator from having to be involved with the task of recording AA menus, allowing him or her to delegate the task to more appropriate team members. For details on enabling this feature, please see the *ShoreTel 7.5 Administration Guide*.

Call Handling Delegation

Some users of the ShoreTel system, particularly senior management, often have an administrative assistant who helps them manage items such as their email, calendar, and voice communication. The ShoreTel 7.5 system administrator can grant permission from ShoreWare Director to individual users to change another’s current call handling mode (CHM) settings. Users who have been delegated to change CHM settings can make changes to the current CHM settings for other users using Operator Call Manager. The Web Access CHM client also includes this capability. For more information on configuring call handling delegation, see the *ShoreTel 7.5 Administration Guide*.

Web Access

Web Access is a browser-based interface that allows users to change their call handling mode and options. Mobile users can change their call handling options from any computer connected to the intranet or Internet. Web Access can be a public URL for remote access or restricted to the LAN.

To open ShoreTel Web Access from within a ShoreTel 7.5 system:

Step 1 Open your browser and type:

```
http://<servername>/shorewarewebclient
```

in the URL address text box, where <servername> is the name of your ShoreTel server.

Step 2 Press Enter. The Web Access login page appears in your browser.

Step 3 Log in with you client ID and password.

For information on how to provide Internet access to ShoreTel's Web Access client using Apache Server as a reverse proxy, see Appendix E, "Enabling Internet Access to ShoreTel Web Access."

Bridged Call Appearances

The Bridged Call Appearances (BCA) feature provides "bridged" information between many separate IP phones, offering the benefit of faster call handling between users. The feature is intended for key system environments, such as a small office with a moderate number of trunks, IP phones and users.

Custom buttons are configured on each IP phone so that information about incoming calls to a BCA extension is shared among the phones via blinking colored LEDs. Similarly, IP phones can share information about outbound calls placed from a BCA extension by blinking green or red on each phone (see the *ShoreTel 7.5 Administration Guide* for details).

Custom buttons can be programmed on IP phone such that each button represents a position in the call stack.

NOTE Pressing the top-most BCA custom button for outbound calls does not necessarily access trunk 1. There is no one-to-one correlation between the custom buttons programmed for BCA extensions and a particular trunk. Trunks can be associated with BCA extensions in any random manner desired by the system administrator.

Switch Support for Bridged Call Appearances

The newer ShoreGear-120/24, ShoreGear-90, ShoreGear-60/12, ShoreGear-50, ShoreGear-40/8, and ShoreGear-220T1/E1 voice switches support BCA functionality. However, the following caveats apply:

- Up to 24 BCA extensions can be configured per switch.

- The sum of all the trunks that are assigned to a BCA, plus the call stack size of all BCAs used for extension appearances on a switch cannot exceed 24. For example, you may configure 8 BCAs, each targeted with 3 trunks on the same switch.
- A maximum of 32 phones can be configured to point to the same BCA extension.
- Up to 128 BCA extensions (on other switches) can be monitored.

Note that BCA extensions cannot be configured on the following legacy ShoreTel voice switch models: IPBX-24, IPBX-12, IPBX-TW, and IPBX-T1

However, these legacy switches can monitor up to 64 BCA extensions that reside on newer switches that provide full BCA support.

For details on configuring the BCA feature, please refer to the *ShoreTel 7.5 Administration Guide*.

Hunt Groups

Hunt groups allow you to route calls to a list of extensions. Hunt groups can be accessed through an extension, DID, and/or DNIS. Hunt groups are supported by ShoreGear switches and remain available when connectivity to the ShoreWare servers are lost. The hunt group can be used as the backup destination for a workgroup, so that some basic hunting can be done even when the workgroup server is not reachable. To maximize reliability, assign hunt groups to a switch close to the majority of the members and/or trunks associated with the hunt group.

A maximum of 8 hunt groups can be assigned to a single switch. A total of 16 user numbers can be assigned to hunt groups on a single switch (i.e., 8 hunt groups with 2 extensions each, 2 hunt groups with 8 extensions, or 1 hunt group with 16 extensions).

Hunt groups have scheduled call handling modes similar to route points (for more information about route points, see the “Setting Call Control Options” chapter in the *ShoreTel 7.5 Administration Guide*). There are call handling modes for on-hours and off-hours/holiday (combined). For on-hours, destinations can be set for Always, Busy, and No Answer. For the other call handling modes, only a call forward always destination is provided. When the hunt group is in a call handling mode other than on-hours, the hunt group forwards calls to the Call Forward Always destination.

A hunt group can be a destination anywhere in the system where a workgroup is allowed as a destination. This includes call forward destinations from users, workgroups, route points, personal assistants, site operators, site fax redirect extensions, and Find Me destinations.

Hunt Group Busy State

The hunt group can be set as busy from both the switch maintenance page in Director and with a star code from the Telephone User Interface. This feature allows hunt group members to disable hunt group routing when they are temporarily unavailable or leave work early. The busy state of the hunt group is maintained by the hunt group’s switch and is not saved in the configuration database or to flash memory. When a switch boots or reboots, the hunt group is in the “available” state.

Use the star code “*18” followed by the hunt group extension, to toggle the busy state of the hunt group from a telephone. A class of service setting controls whether a user can change the hunt group busy state.

When the hunt group is in the busy state during on-hours, calls are forwarded to the busy destination.

Configurable Hunting

There are two types of hunting available with hunt groups: top down or simultaneous ring. All hunt group members are hunted for each call received. For example, in top-down hunting, if the switch is hunting members for an initial call when a second call is received, the second call hunts through all the members again. In other words, each call is hunted independently and in the case of top down, hunting starts at the top.

You can also configure:

- The number of rings per member (the same number of rings are used for each member to whom the call is offered).
- Whether calls should go to a no answer destination after all members have been hunted once or whether members are rehunted.
- Whether multiple calls are offered to a member simultaneously when the hunt group receives multiple calls. Calls are not offered to members with full call stacks.
- Whether members should be hunted when the member's call handling is set to Call Forward Always (DND).

Hunt Group Applications

Hunt groups provide solutions to a several call routing scenarios.

Backup Routing for Workgroup

To use a hunt group as a backup when the workgroup server cannot be reached, create a hunt group with workgroup members who will serve as backup members. To use the hunt group when the workgroup server is not reachable because of a network outage, admission control, or a server outage, set the workgroup's backup number to the hunt group. When the hunt group is set to offer each member a single call at a time, then call offering is similar to a workgroup. Hunt group members are hunted even though they are logged out or in wrap-up with respect to the workgroup.

Hunt Group as a Call Forward Destination

In a small office where individuals generally receive calls directly, users may want someone in the office to answer calls when they are unable to answer. To handle this situation, create a hunt group with everyone in the small office as a member. Individual users can set their call forward destinations to this hunt group. The hunt group can be configured with simultaneous ring, to hunt members only once, and to go to voice mail with Call Forward Busy and Call Forward No Answer conditions.

When configured as described above, if a user's call was forwarded to the hunt group after it wasn't answered, the hunt switch hunts everyone in the office. If the call was not answered after the maximum number of rings, the call is forwarded to voice mail where the caller can leave a message in the original target's mailbox.

Distribution of Calls to Backup Operators

In this scenario, a primary operator who handles calls to a main company number requires one or more secondary operators to receive the calls when the primary operator becomes too busy.

To create a hunt group to back up the primary operator, create a hunt group with backup operators. Enter the main operator and all the backups as members of the hunt group in the order in which they are to serve as backups. Set the hunt group for

multiple calls to be hunted to a given member, and set the call stack size for each of the users to control the number of calls he or she can receive.

When there are incoming calls to the hunt group, the primary operator is offered the calls first. The operator may be offered multiple calls concurrently up to the limit of his or her call stack. If a member's call stack is full, the member is skipped and that particular call is not be offered again (unless the hunt group is set to hunt forever and no member picks up the call before the member is reached again in the hunt list).

If a member of the operator group does not answer the hunt call, the call is offered to the next member after the number of rings configured for call forwarding. Thus, even if the primary operator has room on his or her call stack, the call is offered to the next member in the list when the operator does not answer the call in time.

If you want calls to go directly to a backup when the primary operator is not available, then set the hunt group not to hunt the members when their current call handling mode is set to Call Forward Always (DND). Operators can use this configuration to pass calls to other hunt group members by changing their call handling mode to Call Forward Always.

You may wish to have a hunt group that goes immediately to voice mail or another number during non-working hours. The hunt group can be configured with an off-hours schedule. Setup a schedule for on-hours during which the call handling mode for the hunt group is configured to forward calls to another number only if the hunt group is busy or no one answers. For off-hours, set the hunt group to call forward always to voice mail or another number. The auto-attendant automatically changes the hunt group's current call handling mode based upon the configured schedule.

Common Line Monitoring

A hunt group can be used for line monitoring. For example, several operators may wish to monitor the same line and all have an opportunity to answer calls at the same time. For this case, set up a hunt group with simultaneous ring. When a call is received, the hunt switch rings all operators in the hunt group whose call stack is not full to the number of rings configured. If the hunt group is set to hunt forever, when the number of rings is reached the hunt switch rehunts the same users again. However, the members who have room on their call stack for additional calls may have changed, so each additional hunt may result in different phones ringing.

Pickup Groups

Group Pickup is a traditional PBX and key system feature used in group environments. The feature allows users in a pickup group to answer any ringing phone in that group, and the feature works best in places where several people work together on a daily basis, such as design firms. If a group member is away from her desk and across the room while her phone rings, she can quickly answer the call from another person's IP phone by pressing the relevant soft key or programmable button, or by using a simple star command from an analog phone.

The following example may help illustrate how this feature is used.

Assume three hypothetical users (e.g. Mike, Joe, and Sarah) work together and have jobs that require extensive collaboration. They also sit near one another. Their extensions (x1001, x1002, x1003, respectively) would be added to an extension list, and then this list would be associated with a pickup group.

The pickup group would have its own extension (e.g. x3755). Note that this extension is invalid and cannot be dialed, and thus acts more like a code than an extension. This non-dialable extension could be programmed into a PCM toolbar button or an IP phone programmable button on Mike's, Joe's, and Sarah's phones.

So, assume Joe's phone rings (x1002) while he is having a conversation with Sarah at her desk. He would hear his phone ringing at his desk, yet he could press the pre-programmed button on Sarah's IP phone in order to answer his own call.

Alternatively, if Sarah had an analog phone, Joe could press *13 + 3755 to answer the call.

Pickup groups can include the following types of extensions:

- User extensions
- Workgroup extensions
- Bridged Call Appearance (BCA) extensions

Details

- Pickup groups can be associated with a programmable toolbar button, or with a programmable button on an IP phone, and can work with Office Anywhere.
- The user whose phone will be picked up must have class of service “Call Pickup Allowed” to use this feature. However, other users need not be members of the pickup group to pickup a call.
- This feature is not supported on the following legacy ShoreTel switch models: ShoreGear T1 and ShoreGear E1.
- The call pickup feature will support:
 - 24 members per group
 - 16 groups per switch
 - The sum of all members assigned to all Pickup Groups on a switch cannot exceed 80
 - A single user can be a member of up to 5 Pickup Groups
- A single switch can host a combined total of up to 24 Hunt Groups, Bridged Call Appearances, and Pickup Groups.
- Users can use this feature in several different ways:
 - **IP Phone** – If a programmable button has been configured for Pickup Groups, the user can press the button, or key, and enter the extension for the Pickup Group to answer the call.
 - **IP Phone** – If a soft key has been programmed, the user can press the “pickup” soft key and enter the extension to answer the call.
 - **PCM** – If one of the pre-programmed buttons in PCM has been set up for Pickup Groups, a user can enter the extension of the Pickup Group to answer the call. If the key has already been programmed with the extension of the Pickup Group, then it is not necessary to enter the extension.
 - **PCM** – Alternatively, the user can access the “pickup” command from the Call Menu, followed by the extension.
 - **Analog Phone** – The user can enter the *13 command, followed by the Pickup Group extension to answer calls from an analog phone.

Workgroups

The ShoreTel 7.5 system supports up to 128 workgroups, with up to 300 members per workgroup. (The Simultaneous Ring feature is limited to 16 members.) A workgroup enables a group of users to appear as a single unit to calling parties. Calls can be routed in top-down, longest-idle, round-robin, and simultaneous-ring fashion. Workgroups are typically used by support and sales groups to help automate call handling.

The ShoreTel 7.5 system provides a Workgroup Agent Call Manager and Workgroup Supervisor Call Manager with the proper software licenses. In addition, you can run workgroup reports on the server to help you understand and assess workgroup activity and performance.

NOTE ShoreTel analog phones do not display Caller ID for calls forwarded from a workgroup.

Agent Multiplicity

Users can be members of multiple workgroups. The workgroups can be configured for any hunt pattern and can have queuing enabled.

A single agent status is applied to all workgroups of which the user is a member. With one status, an agent is either logged-in, logged-out, or in wrap-up for all workgroups of which he or she is a member. In order to manage their own logged in status, users must be provisioned with Agent Call Manager. Agents can manage their logged-in state via Agent Call Manager, or through the TUI menu in their voice mailbox or via their IP phone programmable button.

When an agent is a member of more than one workgroup, that agent can receive calls from any of the workgroups. When an agent is available to take calls from more than one workgroup, and the workgroup would select that agent based on the current hunt pattern for a call, the oldest call is offered to the agent.

Queue Monitor shows calls from all the queues of which the user is a member. If the user is a member of only one queue, there is no change to the interface. However, if the user is a member of multiple workgroups, the Queue Monitor shows statistics for each workgroup, and for all workgroups. The user can specify a filter to show only a subset of the queues. The filter only changes the information displayed and does not alter the hunting behavior; the user will still be offered calls from all workgroups of which the user is a member.

For workgroup supervisors the Agent Monitor shows all agents from the workgroups of which the supervisor is a member. The Agent Monitor also allows supervisors to filter agents being monitored by selecting individual workgroups.

Call Monitor and Barge In

Call Monitor creates a limited conference call where the monitoring party hears the other parties, but the monitored parties do not hear the monitoring party. When a call is being monitored, a warning tone may be played to the participants of the call. The warning tone can be disabled using an option for an Auto-Attendant Menu. Call center administrators typically disable the warning tone to silently evaluate agent performance. When the warning tone is disabled, the menu prompt typically informs the caller that their conversation may be monitored or recorded.

Barge In allows one party to join an existing call as a fully conferenced participant. When Barge In is initiated, a brief intrusion tone is played to the other participants.

A recording warning tone may be played to the customer during silent monitor. The warning tone is enabled from ShoreWare Director. No tone is played during a Barge In call.

NOTE ShoreTel, Inc. does not warrant or represent that your use of silent monitoring or barge in features of the Software will be in compliance with local, state, federal or international laws that you may be subject to. ShoreTel, Inc. is not responsible for ensuring your compliance with all applicable laws. Before configuring the call monitoring features, you may wish to consult with legal counsel regarding your intended use.

To simplify discussion of this feature, we will refer to three parties: the supervisor, the agent, and the customer. The supervisor initiates the silent monitor by selecting an agent. The agent is on a call with the customer. The customer may be an internal or external caller, but supervisors and agents must be on extensions.

In Silent Monitor, a supervisor hook flash is ignored. However, a hook flash by the other parties works the same as in a two-party call. In particular, an agent flash puts the call on hold and allows a consultative transfer or conference.

Because there is a limit of three parties in a conference call, if the agent or customer makes a consultative transfer or conference, the supervisor is automatically dropped. Similarly, if another party barges in a monitored extension, then the silent monitor is dropped.

If a conference call is already in progress, it cannot be monitored. If a silent monitor is already in progress, no one else can monitor the call.

The supervisor can barge in on a call he or she is silent monitoring. It is not possible to revert a barge in call to a monitored call. If desired, the supervisor can hang up and restart monitoring.

After a barge in, the agent remains the controlling party of the call. A subsequent agent hook flash disconnects the supervisor, who is the last party added.

Barge In and Silent Monitor Telephony COS Configuration

Each telephony class-of-service (COS) permissions has several additional check boxes and radio buttons in ShoreWare Director to configure Intercom/Paging, Barge In, Call Recording, and Silent Monitor.

Allow initiation for Intercom/Paging—If this check box is selected, users within this COS may place an intercom call or page to other system users. If cleared, then no intercom/paging can be initiated.

Accept Intercom/Paging—Radio button choices are:

- **Accept None:** If selected, users within this COS may not receive intercom calls or pages.
- **Accept All:** If selected, users within this COS may receive intercom calls or pages from anyone in the COS.
- **Accept Only From:** If selected, users within this COS may only receive intercom calls or pages from the person specified in the associated field.

Allow initiation for barge in—If this check box is selected, users within this COS may barge in on the calls of other system users. If cleared, then no barge in can be initiated.

Accept barge in—Radio button choices are:

- **Accept None:** If selected, users within this COS may not receive barge-in's from anyone.

- **Accept All:** If selected, users within this COS may receive barge-in's from anyone else with this COS permission.
- **Accept Only From:** If selected, users within this COS may only receive barge-in's from the person specified in the field associated with this radio button.

Allow initiation for record others calls—If this check box is selected, users within this COS may record the calls of other system users. If cleared, then no call recording of others can be initiated.

Accept record others calls—Radio button choices are:

- **Accept None:** If selected, users within this COS may not have their calls recorded from anyone.
- **Accept All:** If selected, users within this COS may have their calls recorded from anyone else with this COS permission.
- **Accept Only From:** If selected, users within this COS may only have their calls recorded by the person specified in the field associated with this radio button.

Allow initiation for silent monitor—If this check box is selected, users within this COS may monitor other system users. If cleared, then no monitoring of others can be initiated.

Accept silent monitor—Radio button choices are:

- **Accept None:** If selected, users within this COS cannot be monitored by anyone.
- **Accept All:** If selected, users within this COS can be monitored by anyone else with this COS permission.
- **Accept Only From:** If selected, users within this COS can only be monitored by the person specified in the field associated with this radio button.

There are no special permissions for ShoreTel Contact Center agents or supervisors. They must have these same COS permissions with appropriate settings to enable contact center silent monitoring and barge in.

ShoreWare Call Manager

The ShoreTel 7.5 system provides a multilevel ShoreWare Call Manager to address the various needs of the enterprise user.

- Every user on the system may be provided with the **ShoreWare Personal Call Manager** for desktop call control, unified messaging, directory services, and call logging.
- More sophisticated users will appreciate the additional capabilities provided by the **ShoreWare Advanced Call Manager**. The added features are especially useful for those who need information about their calls. At this level, the QuickDialer shows if the destination is busy and indicates the call handling status of the destination (standard or nonstandard).
- The **ShoreWare Workgroup Agent Call Manager** is especially useful to members of workgroups. This level of the Call Manager provides agents with a shared mailbox, the ability to view calls in a queue, and the ability to log in and out of the workgroup.
- The **ShoreWare Workgroup Supervisor Call Manager** is configured for supervisors in a workgroup. This level provides the additional capability of viewing and controlling the status of the agents.
- The **ShoreWare Operator Call Manager** is the most capable level of the Call Manager and is configured for use by operators, secretaries, and executive

assistants. This level provides additional user status information that makes for more effective call routing, including an extension monitor.

For information on Call Manager licenses, see the *ShoreTel 7.5 Administration Guide*.

SoftPhone

SoftPhone is a licensed feature that is enabled through the User edit page of ShoreWare Director. Licensed users can launch SoftPhone from within Call Manager, enabling users to bring their extension to any Windows XP Pro/Vista computer connected to the network with Internet Explorer 6 or (or IE 7).

SoftPhone communicates with other ShoreTel system components (such as ShoreGear voice switches, and IP phones) using the MGCP protocol for call control and RTP media streams using either G.729a or G.711 codecs.

NOTE While SoftPhone can be configured for different types of audio endpoints (headset, speakers, handset), ShoreTel recommends using a USB headset for optimal voice quality.

NOTE SoftPhone uses an IP phone port on a ShoreGear switch, so at least one port must be kept free on the designated ShoreTel switch to use this feature.

The SoftPhone supports:

- Desktop speakers, USB headset, or soundcard headset
- G.711 and G729a codecs
- Quality of Service through TOS/DiffServ

Table 11-1 lists the option settings for SoftPhone.

Table 11-1 SoftPhone Options

Option	Comments
Network Adapter	Allows the user to select which network interface to use. Normally, the default value can be accepted.
Sounds Devices for Playback and Recording	Accept the default devices unless the SoftPhone is using a USB headset.
Device Type	There are three devices possible: headphones, desktop speakers, and telephone. Headphones enable automatic gain control (AGC) and Desktop Speakers enable both acoustic echo cancellation (AEC) and AGC. The Telephone option does not use either AEC or AGC.

The SoftPhone requires a full-duplex sound card. For more information on SoftPhone requirements, see Chapter 12, “Desktop Requirements.”

Enterprise Telephony Features

Music on Hold

The ShoreTel 7.5 system can provide music on hold on a per-site basis using the audio input port on the ShoreGear-120/24, ShoreGear-90, ShoreGear-60/12, ShoreGear-50, ShoreGear-40/8, ShoreGear-220T1 and ShoreGear-220E1 voice switches. You only need a single music source per site.

Connecting the desired music source to the designated ShoreGear voice switch provides music on hold. The source can be either recorded music or custom music, with prerecorded announcements or other information for callers.

NOTE Each site with music on hold must have its own music source. To conserve bandwidth, music is not sent across the WAN between sites, and MOH is selected by the ShoreGear Switch where the CO trunks are configured (i.e., the holding party). IP phone users will not receive MOH when they are on an internal call. See the *ShoreTel 7.5 Administration Guide* for additional information.

Before installing the system, confirm that you have music sources for each site, including the music and the required equipment for playback.

Details related to MOH over SIP Trunks:

MOH for SIP trunks is offered for environments where external users reach the ShoreTel system through SIP trunks (such as BRI via a SIP gateway), and MOH will be offered internally, in situations where the SIP protocol is used to reach the ShoreTel system through SIP devices, such as a WiFi phone.

- If there is a MOH source at the same site as a SIP trunk, these trunks will be connected to that source when placed on hold, and the device at the other end of the trunk will connect directly to the MOH switch.
- The existing rules for MOH will also apply to MOH for SIP Trunks:
 - MOH will not be sent across sites.
 - The MOH source must be at the same site as the SIP trunk that utilizes it.

Limitations:

- MOH is not supported over the SIP tie trunk towards analog phones, analog trunks or PRI trunks. Currently, MOH is sent over the tie trunk and is not generated by the local device.
- MOH Works for the following SIP trunk devices:
 - Hitachi Phone
 - SIP BRI gateway
 - PolyCom SIP phone
 - SIP Service Provider Network (e.g., Masergy).
- MOH is supported across SIP Tie Trunk to IP Phone in the following scenarios:
 - From an IP phone to another IP phone
 - From an analog phone to an IP phone (i.e. putting the call on hold from an analog phone)
 - From any trunk (PRI/analog) while placing an IP phone caller on hold
 - From any phone type to a SIP trunk device such as a Hitachi phone over the SIP tie trunk and onto the SIP trunk device

Overhead Paging

The ShoreTel 7.5 system can provide single-zone overhead paging on a per site basis using the audio output port associated with the ShoreGear-120/24, ShoreGear-90, ShoreGear-60/12, ShoreGear-50, ShoreGear-40/8, ShoreGear-220T1 and ShoreGear-220E1 voice switches.

For sites that require overhead paging, you must designate one of the ShoreGear voice switches to provide paging. In addition, you must provision your selected paging equipment for connection to the ShoreTel 7.5 system.

Paging Groups

As an alternative to a paging system, you can designate groups of system extensions that can be paged by dialing a single system extension. In this way, audio is routed to a group of phones and played on the phone speaker as opposed to playing the audio announcement on an overhead paging system.

With that said, you can also add a paging extension (associated with a site's overhead paging system) to a paging group in order to simultaneously play audio on a group of phones AND an overhead paging system. Refer to the *ShoreTel 7.5 Administration Guide* for details.

Pages to on-hook IP phones will automatically be announced on the IP phone speaker. Pages to IP phones or analog phones that are already on a call will be treated as a normal call. Call handling modes do not apply to page calls.

A maximum of 100 extensions can be paged at one time. Group paging is not available to external callers.

NOTE Please refer to Product Bulletin ST0200 on the ShoreCare website for details on setting up Paging Groups and for details on other network considerations.

Night Bell

The ShoreTel 7.5 system can provide an overhead night bell on a per site basis using the audio output port associated with the ShoreGear-120/24, ShoreGear-90, ShoreGear-60/12, ShoreGear-50, ShoreGear-40/8, ShoreGear-220T1 and ShoreGear-220E1 voice switch.

Intercom

A user can initiate an intercom call through a programmable button on an IP phone that has been programmed with the Intercom feature, via the Call Manager, or via the phone by entering “*15” + extension number. Users must be configured to use the intercom feature through ShoreWare Director.

All intercom calls defeat the user's call coverage (Call Handling Mode settings) and cannot be forwarded.

An intercom call to an idle IP phone is auto-answered and connected through the called party's speakerphone. Immediately after the call is auto-answered, the called party hears an announcement tone and the calling party hears a beep tone. If the called phone was taken off-hook automatically, the switch puts the phone back on-hook when the intercom call terminates.

An intercom call to an analog phone or SoftPhone that is off-hook with no active call (for example, in hands-free mode) is auto-answered through the audio device that is currently active. If the called party is on-hook or is on an active call, the call is offered as an ordinary call, except that call coverage is still defeated.

An intercept tone (fast-busy) is played if the calling user does not have the appropriate permissions. If the called party does not accept intercom calls due to CoS permissions, the call is offered as an ordinary call.

Intercom Telephony COS Configuration

Each telephony class-of-service permissions has two additional check box settings in ShoreWare Director to configure intercom permissions.

Allow initiation for Directed Intercom/Paging—If enabled, users with this COS may make intercom calls to other users of the system. If disabled, then intercom calls cannot be made.

Accept Directed Intercom/Paging—If enabled, users with this COS may accept intercom calls. If disabled, then intercom calls are received as normal calls.

Call Recording

The ShoreTel 7.5 system provides the capability for users to record calls. In order to use call recording, the feature must be configured in ShoreWare Director by a system administrator. Please refer to the *ShoreTel 7.5 Administration Guide* for details on configuring this feature.

Users can use Personal Call Manager (PCM) to request that a call be recorded to voice mail. Supervisors may use Agent Monitor to record an agent's call. Ordinarily, both PCM and Agent Monitor will indicate when a call is being recorded, (although this behavior can be overridden with the "Silent Recording" feature to prevent agents from knowing that their calls are being recorded.)

With Silent Recording, if the call is recorded by the workgroup supervisor, the indicator does not appear in Agent Monitor. (The person invoking the recording sees the indicator—other parties do not.) In this way, calls can be silently recorded to allow operators and supervisors to hide the fact that they are recording agents' calls. This hidden behavior may be desirable when a supervisor is monitoring the telephone manners of a new employee. When the recording is silent or hidden, PCM offers no visual or audible indication that the call is being recorded, and the periodic beeping sound (used to notify call participants that their calls are being recorded) is suppressed.

The ShoreGear-120/24, ShoreGear-90, ShoreGear-60/12, ShoreGear-50, ShoreGear-40/8, ShoreGear-220T1 and ShoreGear-220E1 switches can support as many simultaneous recordings as there are trunk ports. The IPBX-24 and IPBX-T1 switches support a maximum of 8 simultaneous recordings.

The following limitations apply to call recording:

- Call recording is only available via Personal Call Manager or a programmable button on IP phones
- Only calls on trunks (not extensions-to-extensions) may be recorded
- 2-way and 3-way calls may be recorded as long as one of the legs of the call is a trunk
- Calls to a ShoreTel Conference Bridge cannot be recorded

- Recording stops when the call is parked, unparked, or transferred

NOTE ShoreTel, Inc. does not warrant or represent that your use of call monitoring or recording features of the software will be in compliance with local, state, federal or international laws that you may be subject to. ShoreTel, Inc. is not responsible for ensuring your compliance with all applicable laws. Before configuring the call recording feature, you may wish to consult with legal counsel regarding your intended use.

Make Me Conferencing

The ShoreTel 7.5 system allows up to six callers to participate in a conference call. To use the make me conference feature, you need one of the following IP phones: ShorePhone-IP110/115/210/212k/230/530/560/560g, and the proper Class of Service must be configured in ShoreWare Director. If you do not have an IP phone, the feature can also be used from the soft button “join” on an analog phone, in conjunction with PCM. The conference ports must also be reserved on the ShoreGear switch.

NOTE The Make Me conference feature does not require a ShoreTel Conference Bridge.

ShoreTel Conference Bridge

Before you connect and boot the conference bridge, you must allocate 12, 24, 36, 48, or 96 IP ports on ShoreGear voice switches using ShoreWare Director. For more information, see the *ShoreTel 7.5 Administration Guide*.

Next, determine the IP addresses that will be assigned to the conference bridge, and note the identified IP address assignments in your installation plan.

The bridge must have one IP address statically assigned for each port supported by the bridge. This requires you to identify 12, 24, 36, 48, or 96 IP addresses in blocks of 12 consecutive address according to the licensed capacity of your conference bridge.

Additionally, the bridge itself must be assigned a single static address for management and configuration access.

Dialing the Conference Bridge

To provide an extension for users to “dial into” their conference calls, the conference bridge requires a single number (extension) in your dialing plan. This extension is assigned to the first port of the bridge. Internal users reach the conference bridge and their conference calls by directly dialing the extension assigned to the first port. The extension is configured to distribute calls to available ports, which eliminates the need for users to dial directly into a specific port or phone number.

External callers are provided access to the bridge by configuring the appropriate trunks to be directed to the bridge. You can configure one or more of the following options:

- Callers can reach the bridge through a trunk that directs all calls to the conference bridge extension. In this case, the number that external users call is the trunk’s telephone number.
- The conference bridge extension can be associated with a number in your system’s DID or DNIS range to provide direct dialing to the conference bridge. In this case, the number that users call is the DID number assigned to the conference bridge.

- Callers can reach the bridge by selecting the appropriate option from the system auto-attendant. In this case, the access number for the bridge is the number of the system auto-attendant.

The conference bridge is configured with up to three telephone numbers for external access. For more information, see the *ShoreTel Converged Conference Solution Administration Guide*.

ShoreTel Contact Center Solution

If you purchased a ShoreTel Contact Center Solution, you must configure an appropriate number of route points with adequate call stacks. Route points are a licensed feature. Ensure that you have sufficient licenses to support your planned deployment.

For information on route points, see the *ShoreTel 7.5 Administration Guide*. For information on the ShoreTel Contact Center Solution, please review the *ShoreTel Contact Center Solution Installation Guide* and the *ShoreTel Contact Center Solution Administration Guide*.

Desktop Requirements

This chapter describes the hardware and software requirements for installing the end-user desktop client software.

Checklist

Review the following hardware and software requirements before proceeding to the next chapter:

Task Description	See
<input type="checkbox"/> Recommendations	page 12-1
<input type="checkbox"/> Hardware Requirements	page 12-2
<input type="checkbox"/> Software Requirements	page 12-3
<input type="checkbox"/> Network Requirements	page 12-3

The installation procedures are covered in Chapter 18, “Desktop Installation.”

Recommendations

The following recommendations will assist you in planning and installing your desktop computers for the ShoreWare Call Manager applications.

- Verify that each computer meets the minimum hardware and software requirements.
- Install the Client for the Microsoft Networking component.
- Close all applications before installing software.
- Users running Windows XP Professional or Microsoft Windows Vista must have local administrative privileges to install the software.
- Microsoft Outlook must be configured in Corporate or Workgroup mode for Outlook Integration to function properly. Internet Only mode is not supported.
- Users should be informed of which Call Manager application they will be using.

Hardware Requirements

ShoreWare Call Manager applications are installed on end-user PCs. Recommended hardware configurations are given in Table 12-1:

Table 12-1 Recommended Client Hardware Configuration

Application	CPU	RAM	Disk Space (fresh install)	Disk Space (upgrade)	Peripherals
Personal Call Manager	Pentium II 400 MHz	128 MB ^a	70 MB	100 MB	10/100 Base-T, sound card, speaker, and mic. SoftPhone users may require a USB headset.
Advanced Call Manager	Pentium II 400 MHz	128 MB	70 MB	100 MB	100 Base-T, sound card, speaker, and mic. SoftPhone users may require a USB headset.
Agent Call Manager	Pentium II 400 MHz	128 MB	70 MB	100 MB	100 Base-T, sound card, speaker, and mic. SoftPhone users may require a USB headset.
Supervisor Call Manager	Pentium II 400 MHz	128 MB	70 MB	100 MB	100 Base-T, sound card, speaker, and mic. SoftPhone users may require a USB headset.
Operator Call Manager	Pentium II 400 MHz	128 MB	70 MB	100 MB	100 Base-T, sound card, speaker, and mic. SoftPhone users may require a USB headset.
SoftPhone	Pentium II 500 MHz	256 MB	70 MB	100 MB	100 Base-T, full-duplex sound card, speaker, and mic. SoftPhone users may require a USB headset.

a. 256 MB RAM is recommended for all clients running on Windows XP platforms.

Additional Space for Upgrading

Upgrading requires more disk space than a fresh installation because the installer creates backups of all files that are overwritten during the installation. These backups enable the installer to roll back changes if a user decides to cancel the upgrade partway through the installation process. All disk space beyond the fresh installation recommendation is released after the upgrade is completed.

Table 12-2 Minimum Client Hardware Configuration

Application	CPU	RAM	Disk Space (Fresh Install)	Peripherals
Personal Call Manager	Pentium 166 MHz	64 MB	60 MB	Ethernet NIC
Advanced Call Manager	Pentium 266 MHz	128 MB	60 MB	Ethernet NIC
Agent Call Manager	Pentium 266 MHz	128 MB	60 MB	Ethernet NIC
Supervisor Call Manager	Pentium 266 MHz	128 MB	60 MB	Ethernet NIC
Operator Call Manager	Pentium 266 MHz	128 MB	60 MB	Ethernet NIC

Software Requirements

ShoreWare Call Manager applications require the following to run properly (with or without Microsoft Outlook Integration):

Operating Systems	Windows XP Professional <ul style="list-style-type: none"> • SP 2 • Themes supported Microsoft Vista Business Edition
-------------------	---

The following are required when the Microsoft Outlook Integration feature is used:

Microsoft Outlook Versions	Outlook 2002/2003 (SP2), Outlook XP (SP2)
Additional Requirements	<ul style="list-style-type: none"> • Microsoft Outlook must already be installed as the user's email before installing Outlook integration features (see the installation procedure in Chapter 18, "Desktop Installation.") • Outlook must be configured for <i>work-group</i> mode (supporting multiple mail service providers) and not for <i>Internet-only</i> mode before installing Outlook integration features. • Automatic Call Handling with the Microsoft Outlook Calendar requires an optional component of Microsoft Office called Collaborative Data Objects. • The Collaboration Data Object must be installed in order for Microsoft Outlook calendar integration to work.

NOTE For the ShoreTel 7.5 desktop applications to function correctly, you must install the Client for Microsoft Networking.

Microsoft Internet Explorer 7.0 is required for the Web Access call handling application and for the SoftPhone.

Network Requirements

Personal computers running ShoreWare Call Manager software must be networked to the ShoreWare server. See Chapter 9, "Network Requirements and Preparation," for bandwidth requirements.

Citrix and Windows Terminal Server

Citrix and Windows Terminal Server (WTS) technologies enable processing for multiple users to be aggregated on a single Windows computer. The single Windows computer is a process and disk sharing server for multiple users that have lightweight or thin graphics stations on their desktop. Citrix communicates between the server and clients using the ICA protocol, whereas Windows Terminal Server uses the RDP protocol.

Operating Systems	Windows 2003 Terminal Server <ul style="list-style-type: none">• SP1 Windows 2003 Terminal Server <ul style="list-style-type: none">• Release 2 Citrix MetaFrame Presentation Server 4.0
-------------------	--

For information on how to configure and WTS servers to run ShoreTel's Call Manager clients, see Appendix F, "ShoreWare Clients on Citrix and Windows Terminal Servers."

C H A P T E R 1 3

Site Requirements and Preparation

This chapter provides information about preparing your site for the ShoreTel 7.5 system, including concerns such as physical space, environment, and cabling.

Checklist

Review the following site requirement topics before proceeding to the next chapter:

Task Description	See
<input type="checkbox"/> Recommendations	page 13-2
<input type="checkbox"/> Voice Switch Requirements	page 13-3
<input type="checkbox"/> ShoreGear-120/24 Connectors	page 13-10
<input type="checkbox"/> ShoreGear 90 Connectors	page 13-11
<input type="checkbox"/> ShoreGear 90BRI Connectors	page 13-12
<input type="checkbox"/> ShoreGear-60/12 Connectors	page 13-13
<input type="checkbox"/> ShoreGear 50 Connectors	page 13-14
<input type="checkbox"/> ShoreGear-40/8 Connectors	page 13-14
<input type="checkbox"/> ShoreGear-T1 Connectors	page 13-15
<input type="checkbox"/> ShoreGear-E1 Connectors	page 13-15
<input type="checkbox"/> ShoreGear 220T1 Connectors	page 13-16
<input type="checkbox"/> ShoreGear 220E1 Connectors	page 13-17
<input type="checkbox"/> ShoreGear 220T1A Connectors	page 13-18
<input type="checkbox"/> Racks and Cabling	page 13-19
<input type="checkbox"/> Connector Pinouts	page 13-21

Recommendations

The following recommendations will assist you in planning and preparing your site for the ShoreTel 7.5 system.

- Hire a cabling contractor to install your racks, patch panels, and cabling.
- Have an RJ-48C cable ready for each ShoreGear 220T1, ShoreGear 220T1A, ShoreGear 220E1, ShoreGear-T1 and ShoreGear-E1 voice switch.

Switch Models

The ShoreGear-120/24 and ShoreGear-T1 are intended for use in larger sites. For smaller sites, ShoreTel's ShoreGear-60/12, ShoreGear 50 and ShoreGear-40/8 voice switches offer a low-cost VoIP solution. The new voice switches are 1 rack unit (RU) and have an RJ-21X connector for connection to analog phones and trunks. They also feature redundant Ethernet LAN connections for greater availability and reliability.

For information on the IPBX model switches, see Appendix C, "ShoreGear IPBX Voice Switches."

Figure 13-1 shows the ShoreGear-T1 (SG-T1) as representative of the new switches.



Figure 13-1 The ShoreGear-T1 (SG-T1)

You can locate the model number of your switches, SG or IPBX, on the rear panel as shown in Figure 13-2. This document distinguishes between switches based on the model number and the number of RU's the switch occupies.

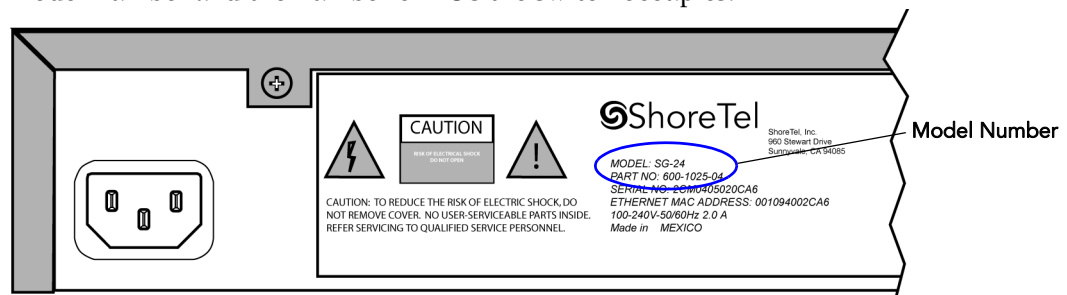

Figure 13-2 ShoreGear-120/24 Model Number Label

Your system may include the following second-generation switches:

- ShoreGear-120/24 Voice Switch (1 RU)
- ShoreGear 90 Voice Switch (1 RU)
- ShoreGear 90BRI Voice Switch (1 RU)
- ShoreGear-60/12 Voice Switch (1 RU)
- ShoreGear 50 Voice Switch (1 RU)
- ShoreGear-40/8 Voice Switch (1 RU)
- ShoreGear 220T1 Voice Switch (1 RU)
- ShoreGear 220T1A Voice Switch (1 RU)

- ShoreGear 220E1 Voice Switch (1 RU)
- ShoreGear-T1 Voice Switch (1 RU)
- ShoreGear-E1 Voice Switch (1 RU)

You may also have the following first-generation switches in your system:

- ShoreGear-24 (IPBX-24) Voice Switch (2 RU)
- ShoreGear-12 (IPBX-12) Voice Switch (1.5 RU)
- ShoreGear-Teleworker (IPBX-TW) Voice Switch (1.5 RU)
- ShoreGear-T1 (IPBX-T1) Voice Switch (1.5 RU)
- ShoreGear-E1 (IPBX-E1) Voice Switch (1.5 RU)

Voice Switch Requirements

This section includes requirements for mounting the ShoreGear voice switches, along with other switch-related requirements and specifications. This section includes information on the following ShoreTel voice switches: ShoreGear-120/24, ShoreGear 90, ShoreGear-60/12, ShoreGear 50, ShoreGear-40/8, ShoreGear-T1, ShoreGear-E1, ShoreGear 220T1, ShoreGear 220T1A and ShoreGear 220E1.

If you are installing the ShoreGear-24 (IPBX-24), ShoreGear-12 (IPBX-12), ShoreGear-Teleworker, ShoreGear-T1 (IPBX-T1), or ShoreGear-E1 (IPBX-E1), see Appendix C, "ShoreGear IPBX Voice Switches."

Physical Requirements

The ShoreGear voice switches are designed to be mounted in a standard 19-inch rack. Table 13-1 shows the specifications for each voice switch. For more information refer to the *Quick Install Guide*, included with each ShoreGear voice switch.

Table 13-1 ShoreGear Voice Switch Physical Specifications

Parameter	ShoreGear-120/24	ShoreGear-60/12	ShoreGear-40/8	ShoreGear-T1	ShoreGear-E1
Dimensions (H x W x D)	1.72" x 17.16" x 14.28 "	1.72" x 17.16" x 14.28 "	1.72" x 17.16" x 14.28 "	1.72" x 17.16" x 14.28 "	1.72" x 17.16" x 14.28 "
	43.68 x 435.86 x 362.71 mm	43.68 x 435.86 x 362.71 mm	43.68 x 435.86 x 362.71 mm	43.68 x 435.86 x 362.71 mm	43.68 x 435.86 x 362.71 mm
Rack mount units	1 RU	1 RU	1 RU	1 RU	1 RU
Mounting position	Front, Center	Front, Center	Front, Center	Front, Center	Front, Center
Weight	9 lbs	9 lbs	9 lbs	8 lbs	8 lbs
	4.08 kg	4.08 kg	4.08 kg	3.62 kg	3.62 kg
Maximum stacked per shelf	3 switches	3 switches	3 switches	3 switches	3 switches

Table 13-2 shows the latest hardware line, designed to increase port density.

Table 13-2 Half-Width ShoreGear Voice Switch Physical Specifications

Parameter	ShoreGear 90BRI	ShoreGear 50	ShoreGear 220T1/T1A/E1
Dimensions (H x W x D)	1.69" x 8.39" x 14.28 " 43 x 213 x 378 mm	1.69" x 8.39" x 14.28 " 43 x 213 x 378 mm	1.69" x 8.39" x 14.28 " 43 x 213 x 378 mm
Rack mount units	1 RU	1 RU	1 RU
Mounting position	Front, Center	Front, Center	Front, Center
Weight	5.3 lbs 2.4 kg	5.3 lbs 2.4 kg	5.3 lbs 2.4 kg
Maximum stacked per shelf	6 switches	6 switches	6 switches

Input Power

For backup purposes, ShoreTel recommends that all ShoreGear voice switches and the ShoreWare server be connected to an uninterruptable power supply (UPS). This ensures that telephone service will continue in the event of a power interruption. Table 13-3 shows the power requirements for the full-width ShoreGear voice switches, while Table 13-4 shows the power requirements for the half-width ShoreGear voice switches.

Table 13-3 ShoreGear Voice Switch Power Input (Full-Width Switches)

Parameter	ShoreGear-120/24	ShoreGear-60/12	ShoreGear-40/8	ShoreGear-T1	ShoreGear-E1
Input voltage	100–240 VAC 50–60 Hz	100–240 VAC 50–60 Hz	100–240 VAC 50–60 Hz	100–240 VAC 50–60 Hz	100–240 VAC 50–60 Hz
Current consumption @110 VAC (maximum)	2A max	2A max	1A max	1A max	1A max
Number of grounded 110 VAC outlets per switch	1	1	1	1	1
Power consumption (typical)	90W typ	90W typ	50W typ	50W typ	50W typ

Table 13-4 ShoreGear Voice Switch Power Input (Half-Width Switches)

Parameter	ShoreGear 50	ShoreGear 90 ShoreGear 90BRI	ShoreGear 220T1	ShoreGear 220E1	ShoreGear 220T1A
Input voltage	100–240 VAC 50–60 Hz	100–240 VAC 50–60 Hz	100–240 VAC 50–60 Hz	100–240 VAC 50–60 Hz	100–240 VAC 50–60 Hz
Current consumption @110 VAC (maximum)	1A max	1A max	1A max	1A max	1A max
Number of grounded 110 VAC outlets per switch	1	1	1	1	1
Power consumption (typical)	40W	40W	17W	17W	40W

Power and Heat Dissipation

The voice switches dissipate power and heat. ShoreTel recommends that you use the information provided in Table 13-5 and Table 13-6 to help calculate the ventilation requirements of the equipment room.

Table 13-5 ShoreGear Voice Switch Power and Heat Dissipation (Full-Width Switches)

Parameter	ShoreGear-120/24	ShoreGear-60/12	ShoreGear-40/8	ShoreGear-T1	ShoreGear-E1
Power dissipation (typical)	90 W typ	90 W typ	50 W typ	50 W typ	50 W typ
Heat dissipation	215 BTU/hour	140 BTU/hour	85 BTU/hour	61 BTU/hour	65 BTU/hour

Table 13-6 ShoreGear Voice Switch Power and Heat Dissipation (Half-Width Switches)

Parameter	ShoreGear 50	ShoreGear 90 ShoreGear 90BRI	ShoreGear 220T1	ShoreGear 220E1	ShoreGear 220T1A
Power dissipation (typical)	40 W typ	40 W typ	40 W typ	17 W typ	17 W typ
Heat dissipation	137 BTU/hour	137 BTU/hour	137 BTU/hour	58 BTU/hour	137 BTU/hour

Environmental Requirements

The ShoreGear voice switches require that the environmental specifications provided in Table 13-7 be met.

Table 13-7 ShoreGear Environmental Specifications

Parameter	Specification
Operating temperature	0° to 50° C (32° to 122° F)
Operating humidity (non-condensing)	10% to 90%
Storage temperature	-30° C to 70° C (-34.4° to 158° F)

Reliability and Availability

Each ShoreGear voice switch is an embedded product with no moving parts other than a highly reliable fan. In addition, the power supply contained within the voice switch has a very high individual mean time before failure (MTBF), as shown in Table 13-8.

Table 13-8 ShoreGear Voice Switch Dependability

Voice Switch	Predicted MTBF (hours)	Demonstrated MTBF (hours)	MTTR (hours)	Availability
ShoreGear-120/24	84,570	320,142	1	99.9997%
ShoreGear-60/12	90,956	152,388	1	99.9993%
ShoreGear-40/8	132,302	314,557	1	99.9997%
ShoreGear-T1	158,229	312,709	1	99.9997%
ShoreGear-E1	154,229	312,709	1	99.9997%

MTBF = Mean time before failure

MTTR - Mean time to repair

Availability = %uptime/time = MTBF/(MTBF+MTTR)

Since the ShoreTel 7.5 system is plug-and-play, a switch can be replaced in minutes.

Distributed call control software means there is no system-wide single point of failure. If a single ShoreGear voice switch fails, all the other voice switches continue to operate.

Table 13-9 shows the reliability information for the ShorePhone phones. Hourly numbers shown are based on demonstrated reliability (as opposed to calculated).

Table 13-9 ShorePhone IP Phone Dependability

Phone	MTBF hours (calculated)	MTBF hours (demonstrated)
IP110	64,800	490,000
IP115	N/A	TBD
IP210	62,100	240,000
IP212k	58,200	350,000
IP230	58,200	350,000
IP530/560	56,300	360,000
IP560g	56,400	TBD
BB24	72,600	TBD

Memory and Processing

Each ShoreGear voice switch has the same memory and processing (see table below).

Table 13-10 ShoreGear Voice Switch Memory and Processing

Type	Details
Flash Memory	16 MB
Random Access Memory	128 MB
Main Processor	PowerPC 8245
Digital Signal Processor	Texas Instruments 5409A

Connectors

Table 13-11 summarizes all of the connectors on the ShoreGear voice switches. Diagrams showing where these connectors are located are provided later in this chapter.

Table 13-11 ShoreGear Voice Switch Connectors

Port/Connector	ShoreGear-120/24	ShoreGear-60/12	ShoreGear-40/8	ShoreGear-T1	ShoreGear-E1
Power	110 VAC	110 VAC	110 VAC	110 VAC	110 VAC
Ethernet	2 RJ-45	2 RJ-45	2 RJ-45	2 RJ-45	RJ-45
Analog telephone/ trunk	RJ-21X male 0–2,000 feet*	RJ-21X male 0–2,000 feet*	RJ-21X male 0–2,000 feet*	— — —	— — —
T1 trunk	—	—	—	RJ-48C	RJ-48C
T1 trunk monitor	—	—	—	RJ-48C	RJ-48C

Table 13-11 ShoreGear Voice Switch Connectors

Audio input (Music on Hold)	3.5 mini-mono	3.5 mini-mono	3.5 mini-mono	—	—
Audio output (Paging, Night Bell)	3.5 mini-mono	3.5 mini-mono	3.5 mini-mono	—	—
Maintenance	DB-9 female	DB-9 female	DB-9 female	DB-9 female	DB-9 female

* 2000 ft. length uses 26AWG wire.

Power Cabling

Each ShoreGear voice switch comes equipped with a standard 110 VAC modular power cord. A localized modular power cord can be ordered from ShoreTel. ShoreTel recommends that every ShoreGear voice switch, as well as the ShoreWare server, be connected to an uninterruptable power supply (UPS).

Ethernet Cabling

Each ShoreGear-120/24, ShoreGear-60/12, ShoreGear-40/8, and ShoreGear-T1 voice switch has two RJ-45 connectors that provide an auto-sensing 10/100M Ethernet interface. These are connected to the local area network using standard Category 5 cabling.

The ShoreGear-120/24, ShoreGear-60/12, and ShoreGear-40/8, and ShoreGear-T1 voice switches come with two network interfaces, LAN1 and LAN2, allowing for a network fault tolerant deployment. You can connect to either or both connectors; there is no primary/secondary relationship. When both are connected, only one will be active at any time. If the currently active interface loses the link, the alternate interface becomes active. Both interfaces will use the same MAC Ethernet address, and IP address.

There are two levels of fault tolerance. To protect against Ethernet switch failure, connect LAN1 and LAN 2 to separate Ethernet switches. To protect against port or cable failure, connect LAN1 and LAN2 to separate ports on the same Ethernet switch.

10 Base-T and 100 Base-T can typically support up to 100 meters.

IP Phone Cabling

Each ShorePhone IP phone has an RJ-45 connector that provides an auto-sensing 10/100M Ethernet interface. This is connected to the local area network using standard Category 5 cabling.

10 Base-T and 100 Base-T can typically support up to 100 meters.

Analog Telephone and Trunk Cabling

The ShoreGear-120/24, ShoreGear-60/12, and ShoreGear-40/8 provide an RJ-21X male connector for mass termination of the telephones and trunks. This should be connected using a standard 25-pair cable. ShoreTel recommends using the RJ-21X and connecting to a patch panel to provide simple moves, adds, and changes.

Telephones can be supported from 0 to 2,000 feet from the voice switch over standard cabling. Use larger gauge wires for longer distances. For example, with a ShoreGear-12 (IPBX-12) and #22AWG wire, you can obtain loop lengths of over 6,000 feet.

NOTE It is recommended that an analog telephone be provisioned in the equipment room for troubleshooting purposes.

The pinouts of the ShoreGear-120/24, ShoreGear-60/12, and ShoreGear-40/8 RJ-21X connectors are shown in the section “Connector Pinouts” on page 13-21.

T1/E1 Trunk and Trunk Monitor Cabling

The ShoreGear-T1 and ShoreGear-E1 voice switches have an RJ-48C connector as the telco interface to the T1/E1 trunk from the telephone service provider.

NOTE These voice switches provide an internal Channel Service Unit (CSU).

The ShoreGear-T1 and ShoreGear-E1 have an additional RJ-48C connector that is wired to the telco interface for the purpose of troubleshooting the T1/E1 interface with specialized test equipment. This connector is normally not used.

Audio Input (Music on Hold) Cabling

The ShoreGear-120/24, ShoreGear-60/12, and ShoreGear-40/8 voice switches each have a 3.5 mm mini-stereo input connector that provides music or some other recording to callers when they are on hold. The input port supports low-level line audio from a preamplifier or mini-CD player, at 47 k Ω nominal impedance. The audio input cable can be up to 10 feet long.

The audio input port on the ShoreGear voice switches is a mono connection. If you connect a stereo input, the stereo signal is converted to a mono signal.

To minimize bandwidth, music on hold is not streamed across the wide area network, so you will need one music source per site.

NOTE The music and music source are not included with the ShoreTel 7.5 system.

WARNING In accordance with United States copyright laws, a license may be required from the American Society of Composers, Authors, and Publishers, or a similar organization, if radio or TV broadcasts are played for music on hold. As an alternative, an ASCAP-approved CD or tape can be used. ShoreTel, Inc. disclaims any liability out of failure to obtain such a license.

Audio Output (Paging and Night Bell) Cabling

The ShoreGear-120/24, ShoreGear-60/12, and ShoreGear-40/8, voice switches each have a 3.5 mm mini-stereo audio output connector for overhead paging and night bell on a per site basis. The audio output port provides low-level line audio with a sufficient input level for a typical amplifier. The paging port output is about one volt peak to peak, similar to the line output of a CD player, and can drive inputs that are 600 ohms or higher.

NOTE The audio output is mono signal. If you use a stereo jack, the signal is available on one channel, but the other channel will be silent.

This is a single-zone paging system. If more zones are required, see the application note on ShoreLink, ShoreTel’s online knowledge base.

Maintenance Cabling

The ShoreGear-120/24, ShoreGear-60/12, ShoreGear-40/8, ShoreGear-T1, and ShoreGear-E1 voice switches support a maintenance port for connection terminal using a standard DB-9 female connector. This maintenance port is typically used only when assigning networking parameters if DHCP or BOOTP is not being used.

ShoreGear-120/24 Connectors

The ShoreGear-120/24 voice switch (Figure 13-3) contains the following components:

- 1 3.5 mm stereo connector for audio input (music on hold)
- 1 3.5 mm stereo connector for audio output (overhead paging and night bell)
- 1 DB-9 female connector for maintenance
- 2 RJ-45 connectors for the LAN interface
- 1 RJ-11 connector for connecting an analog phone (extension 9)
- 1 RJ-21X male connector for mass termination of the telephone/trunk ports

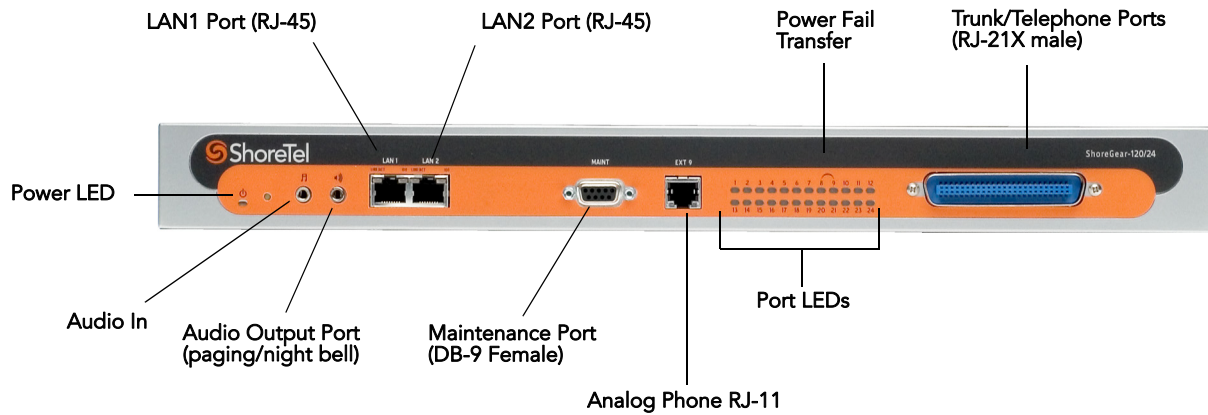

Figure 13-3 ShoreGear-120/24 Connectors and LEDs

ShoreGear 90 Connectors

The SG-90, shown in Figure 13-4, contains the following components:

- 1 3.5 mm stereo connector for audio input (music on hold)
- 1 3.5 mm stereo connector for audio output (overhead paging and night bell)
- 1 DB-9 female connector for maintenance
- 2 RJ-45 connectors for the LAN interface
- 1 RJ-21X male connector for mass termination of the telephone/trunk ports

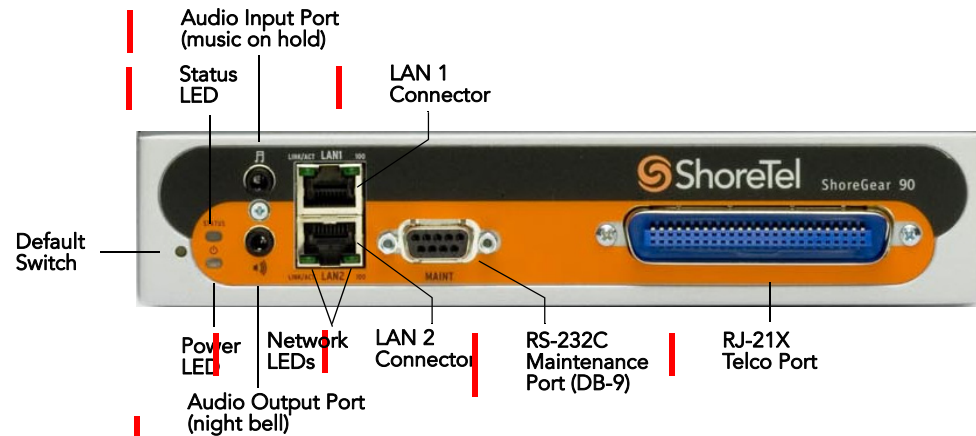

Figure 13-4 ShoreGear 90 Connectors and LEDs

ShoreGear 90BRI Connectors

The ShoreGear 90BRI, shown in Figure 13-5, contains the following components:

- 4 RJ-45 ISDN BRI ports for connecting to telephone company ISDN BRI lines
- 2 RJ-45 connectors for the LAN interface
- 1 RJ-21X male connector for mass termination of the telephone/trunk ports
- 1 3.5 mm stereo connector for audio input (music on hold)
- 1 3.5 mm stereo connector for audio output (overhead paging and night bell)
- 1 DB-9 female connector for maintenance

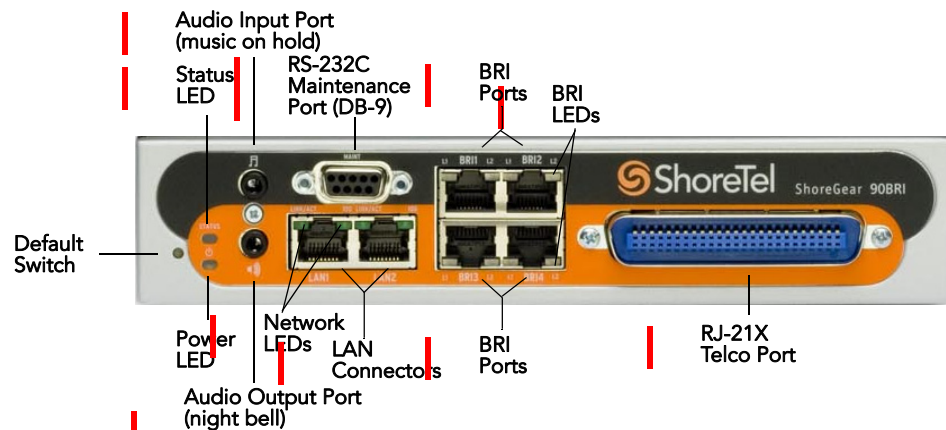

Figure 13-5 ShoreGear 90BRI Connectors and LEDs

ShoreGear-60/12 Connectors

The ShoreGear-60/12 voice switch (Figure 13-6) contains the following components:

- 1 3.5 mm stereo connector for audio input (music on hold)
- 1 3.5 mm stereo connector for audio output (overhead paging and night bell)
- 1 DB-9 female connector for maintenance
- 2 RJ-45 connectors for the LAN interface
- 1 RJ-11 connector for connecting an analog phone (extension 9)
- 1 RJ-21X male connector for mass termination of the telephone/trunk ports

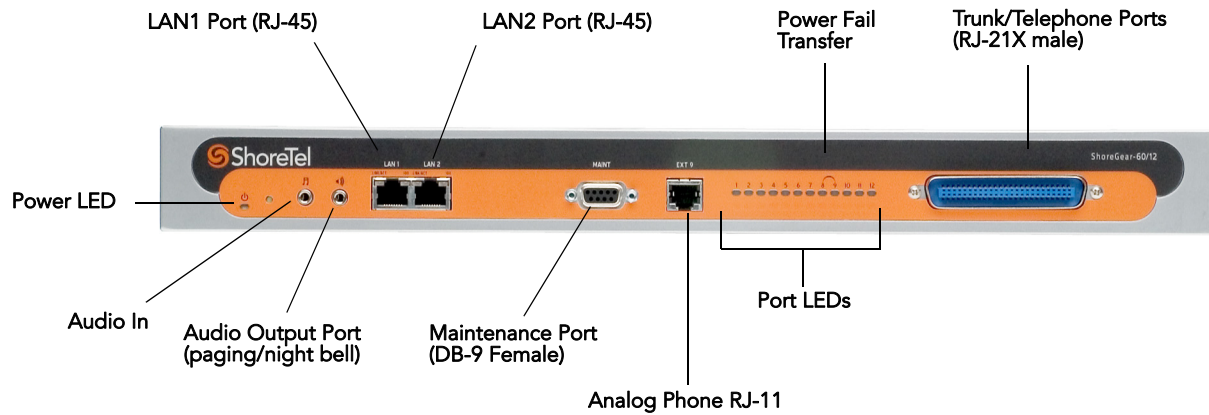

Figure 13-6 The ShoreGear-60/12 Connectors and LEDs

ShoreGear 50 Connectors

The SG-50, shown in Figure 13-7, contains the following components:

- 1 3.5 mm stereo connector for audio input (music on hold)
- 1 3.5 mm stereo connector for audio output (overhead paging and night bell)
- 1 DB-9 female connector for maintenance
- 2 RJ-45 connectors for the LAN interface
- 1 RJ-21X male connector for mass termination of the telephone/trunk ports

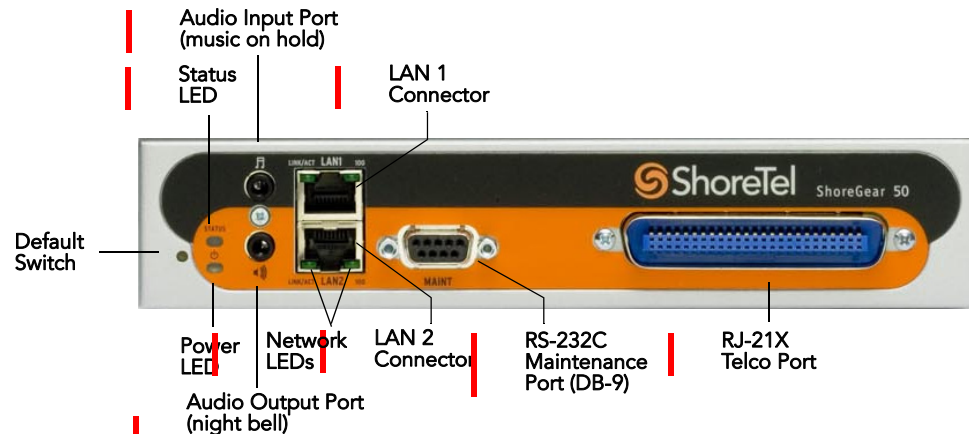

Figure 13-7 ShoreGear 50 Connectors and LEDs

ShoreGear-40/8 Connectors

The ShoreGear-40/8 voice switch (Figure 13-8) contains the following components:

- 1 3.5 mm stereo connector for audio input (music on hold)
- 1 3.5 mm stereo connector for audio output (overhead paging and night bell)
- 1 DB-9 female connector for maintenance
- 2 RJ-45 connectors for the LAN interface
- 1 RJ-11 connector for connecting an analog phone (extension 5)
- 1 RJ-21X male connector for mass termination of the telephone/trunk ports

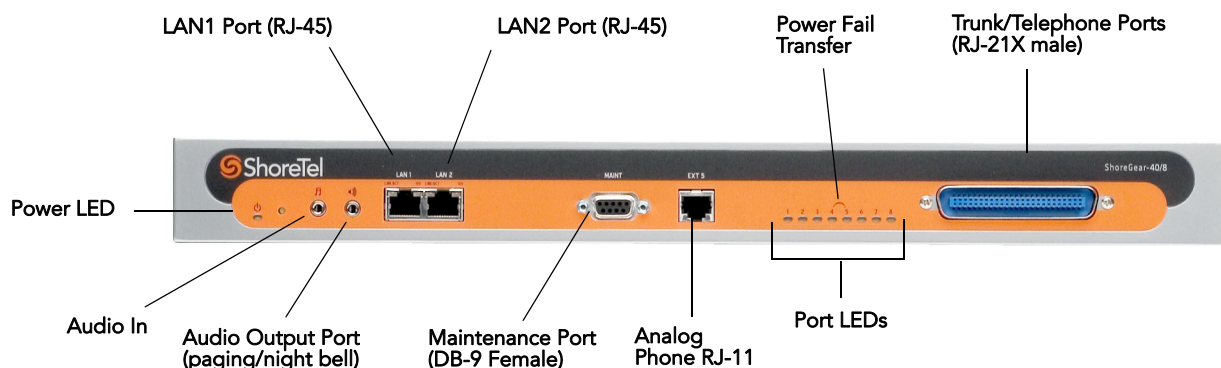

Figure 13-8 ShoreGear-40/8 Connectors and LEDs

ShoreGear-T1 Connectors

The ShoreGear-T1 voice switches (Figure 13-9) contain the following components:

- 1 DB-9 female connector for maintenance
- 2 RJ-45 connectors for the LAN interface
- 1 RJ-48C connector for T1 monitoring
- 1 RJ-48C connector for the T1 interface

NOTE The ShoreGear-T1 provides an internal Channel Service Unit (CSU).

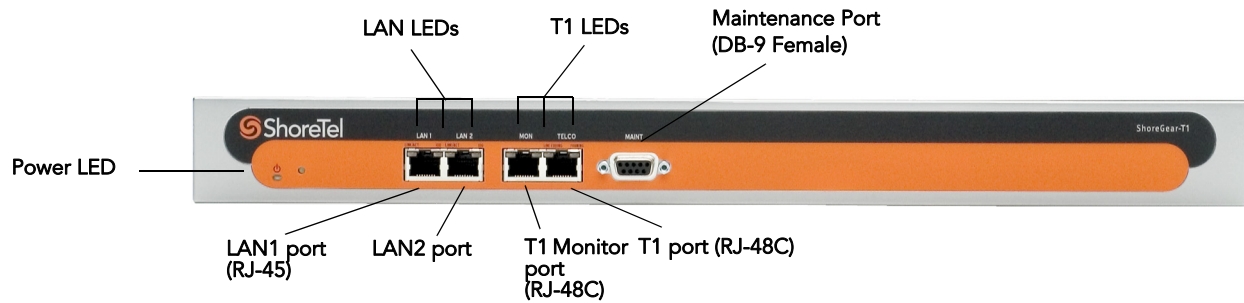

Figure 13-9 ShoreGear-T1 Connectors and LEDs

ShoreGear-E1 Connectors

The ShoreGear-E1 voice switches (Figure 13-10) contain the following components:

- 1 DB-9 female connector for maintenance
- 2 RJ-45 connectors for the LAN interface
- 1 RJ-48C connector for E1 monitoring
- 1 RJ-48C connector for the E1 interface

NOTE The ShoreGear-E1 provides an internal Channel Service Unit (CSU).

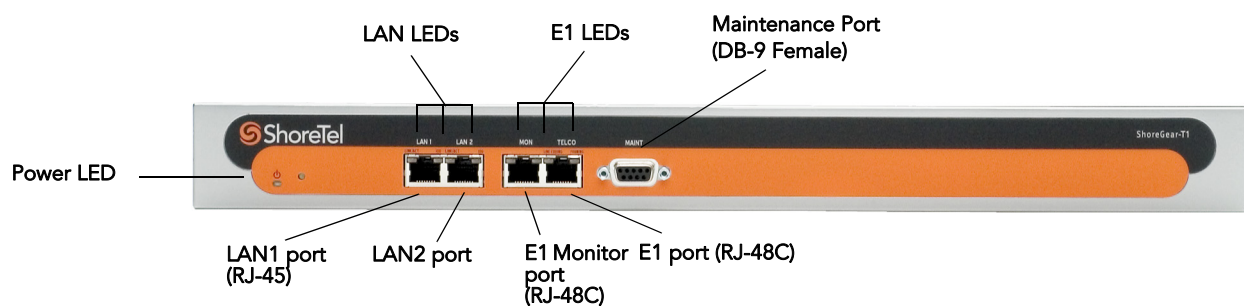

Figure 13-10 ShoreGear-E1 Connectors and LEDs

ShoreGear 220T1 Connectors

The SG-220T1, shown in Figure 13-11, contains the following components:

- 1 3.5 mm stereo connector for audio input (music on hold)
- 1 3.5 mm stereo connector for audio output (overhead paging and night bell)
- 1 DB-9 female connector for maintenance
- 2 RJ-45 connectors for the LAN interface
- 1 RJ-45 Monitor port for connecting test equipment
- 1 RJ-45 Telco port for connecting the switch to a telephone company line

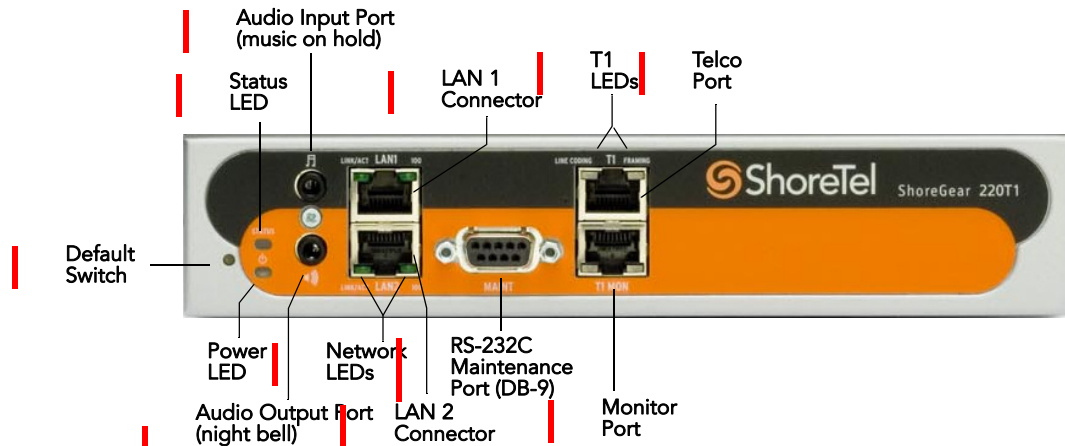

Figure 13-11 ShoreGear 220T1 Connectors and LEDs

ShoreGear 220E1 Connectors

The SG-220E1, shown in Figure 13-12, contains the following components:

- 1 3.5 mm stereo connector for audio input (music on hold)
- 1 3.5 mm stereo connector for audio output (overhead paging and night bell)
- 1 DB-9 female connector for maintenance
- 2 RJ-45 connectors for the LAN interface
- 1 RJ-45 Monitor port for connecting test equipment
- 1 RJ-45 Telco port for connecting the switch to a telephone company line

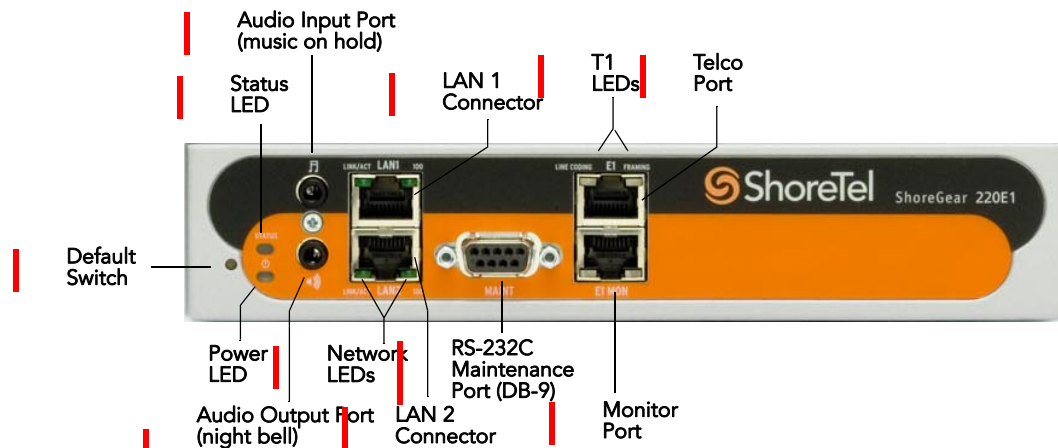

Figure 13-12 ShoreGear 220E1 Connectors and LEDs

ShoreGear 220T1A Connectors

The ShoreGear 220T1A, shown in Figure 13-13, contains the following components:

- 1 3.5 mm stereo connector for audio input (music on hold)
- 1 3.5 mm stereo connector for audio output (overhead paging and night bell)
- 1 DB-9 female connector for maintenance
- 1 RJ-21X male connector for mass termination of the telephone/trunk ports
- 2 RJ-45 connectors for the LAN interface
- 1 RJ-45 Monitor port for connecting test equipment
- 1 RJ-45 T1 Telco port for connecting the switch to a telephone company line

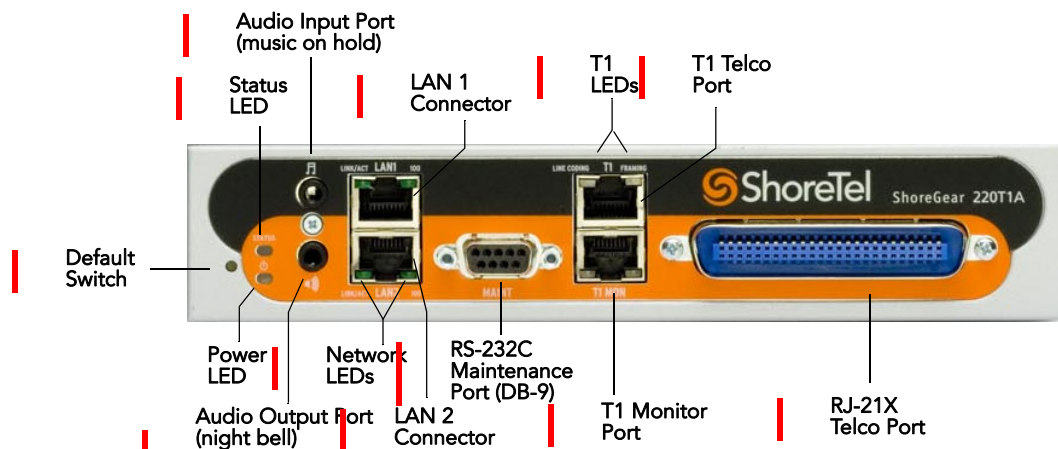

Figure 13-13 ShoreGear 220T1A Connectors and LEDs

Racks and Cabling

General Cabling Overview

The diagram in Figure 13-14 highlights the key components with respect to cabling for your voice network.

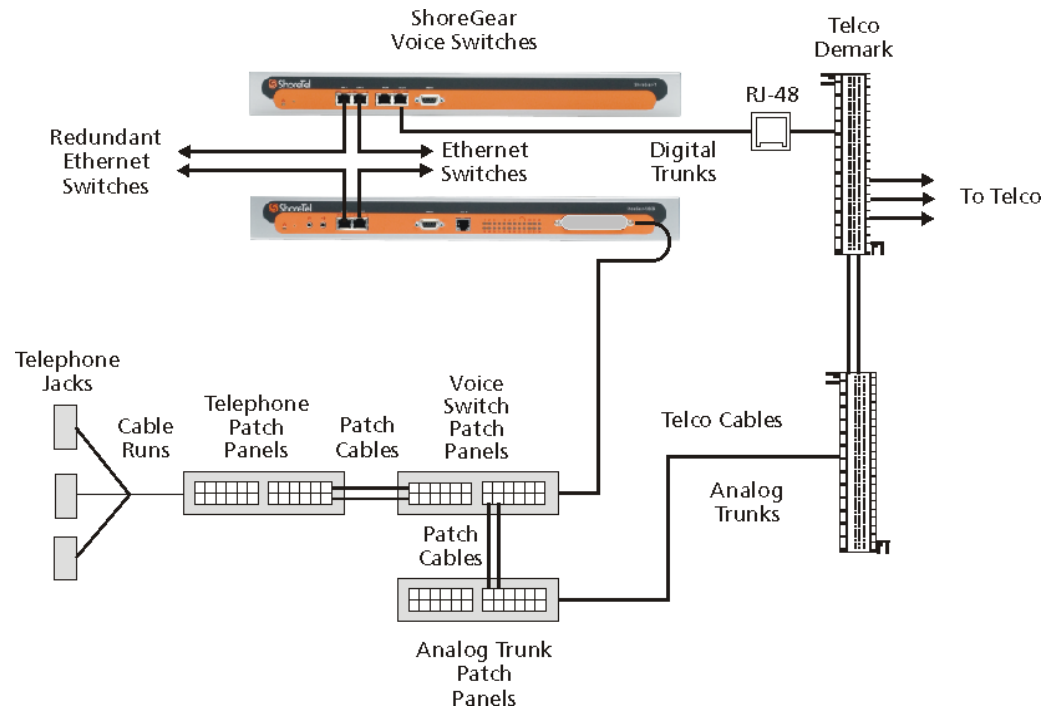

Figure 13-14 Cabling Overview

Starting from the lower left in this diagram, the telephone cabling is organized as follows:

- A telephone jack (RJ-11) is provided for each telephone.
- Telephone cabling (Category 3 or better) is terminated on the telephone jack and runs back to the equipment room to a modular connector (RJ-21X) on a telephone patch panel.
- The telephone patch panel provides a flexible cable management solution for the telephone cabling. The patch panel has RJ-21X connections for the telephone cabling and RJ-11 connections on the front.
- Patch cords are connected from the telephone patch panel (RJ-11) to the voice switch patch panel (RJ-11).
- The voice switch patch panel provides a flexible cable management solution for the voice switches. The patch panel has RJ-21X connections running to the voice switches and RJ-11 connections on the front.

Starting from the right in Figure 13-14, the trunk cabling is organized as follows:

- The digital (T1/E1) and analog trunks are terminated on a punch-down block.
- The digital service is further terminated at a service provider demark with an RJ-48 connector.

An RJ-48 cable from the T1/E1 demark connects to the ShoreGear-T1 or ShoreGear-E1.

- The analog service is cross-connected to a modular (RJ-21X) punch-down block. A telco cable is connected to the modular (RJ-21X) punch-down jack and runs to a modular connector (RJ-21X) on an analog trunk patch panel.

Like the telephone cabling, patch cords are connected from the analog trunk patch panel (RJ-11) to the voice switch patch panel (RJ-11).

NOTE As an alternative, patch panels can be replaced with punch-down blocks. This may be more cost-effective but is less flexible.

Rack Overview

Figure 13-15 shows a typical rack installation.

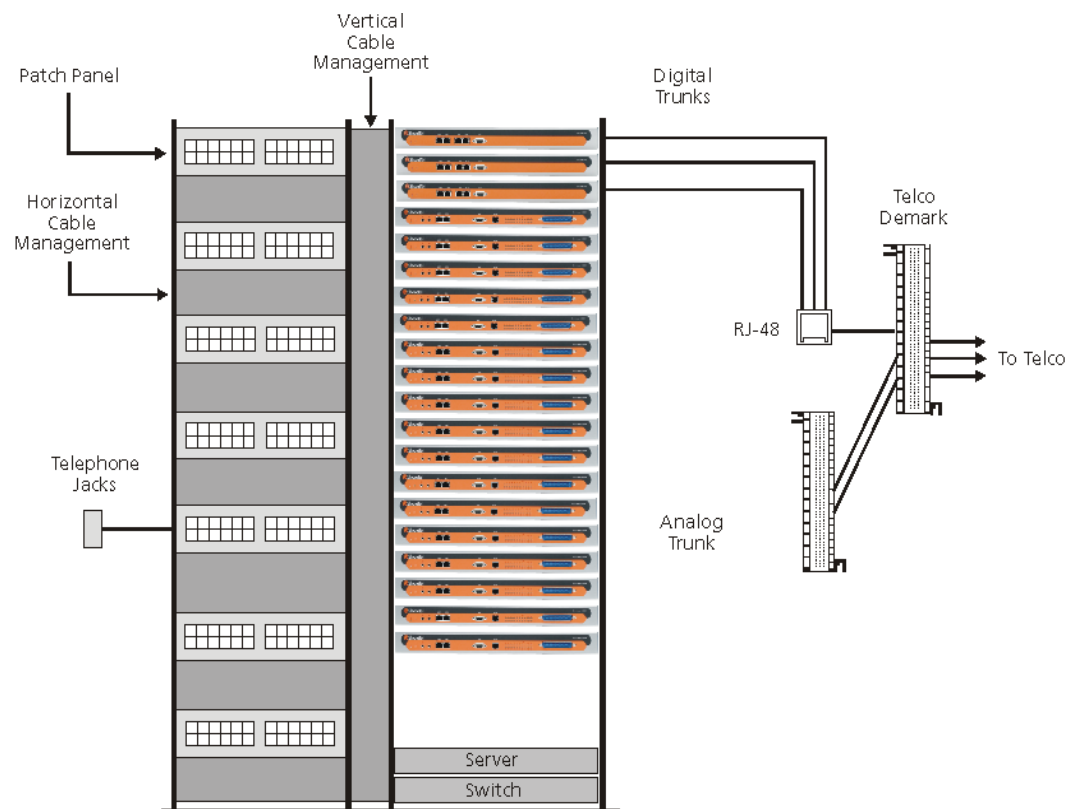

Figure 13-15 Rack Installation

A 19-inch data rack, shelf, and modular patch panels can be purchased from most major electrical suppliers.

Connector Pinouts

ShoreGear-120/24 RJ-21X Telephone and Trunk Connector

1



50

Port	Designation	Pin	Cable Color
1	Tip	26	White/Blue
1	Ring	1	Blue/White
2	Tip	27	White/Orange
2	Ring	2	Orange/White
3	Tip	28	White/Green
3	Ring	3	Green/White
4	Tip	29	White/Brown
4	Ring	4	Brown/White
5	Tip	30	White/Slate
5	Ring	5	Slate/White
6	Tip	31	Red/Blue
6	Ring	6	Blue/Red
7	Tip	32	Red/Orange
7	Ring	7	Orange/Red
8	Tip	33	Red/Green
8	Ring	8	Green/Red
9	Tip	34	Red/Brown
9	Ring	9	Brown/Red
10	Tip	35	Red/Slate
10	Ring	10	Slate/Red
11	Tip	36	Black/Blue
11	Ring	11	Blue/Black
12	Tip	37	Black/Orange
12	Ring	12	Orange/Black
13	Tip	38	Black/Green
13	Ring	13	Green/Black
14	Tip	39	Black/Brown
14	Ring	14	Brown/Black
15	Tip	40	Black/Slate
15	Ring	15	Slate/Black
16	Tip	41	Yellow/Blue
16	Ring	16	Blue/Yellow

Port	Designation	Pin	Cable Color
17	Tip	42	Yellow/Orange
17	Ring	17	Orange/Yellow
18	Tip	43	Yellow/Green
18	Ring	18	Green/Yellow
19	Tip	44	Yellow/Brown
19	Ring	19	Brown/Yellow
20	Tip	45	Yellow/Slate
20	Ring	20	Slate/Yellow
21	Tip	46	Violet/Blue
21	Ring	21	Blue/Violet
22	Tip	47	Violet/Orange
22	Ring	22	Orange/Violet
23	Tip	48	Violet/Green
23	Ring	23	Green/Violet
24	Tip	49	Violet/Brown
24	Ring	24	Brown/Violet
—	Tip	50	Violet/Slate
—	Ring	25	Slate/Violet

ShoreGear 90 RJ-21X Telephone and Trunk Connector

1



50

Port	Designation	Pin	Cable Color
1	Tip	26	White/Blue
1	Ring	1	Blue/White
2	Tip	27	White/Orange
2	Ring	2	Orange/White
3	Tip	28	White/Green
3	Ring	3	Green/White
4	Tip	29	White/Brown
4	Ring	4	Brown/White
5	Tip	30	White/Slate
5	Ring	5	Slate/White
6	Tip	31	Red/Blue
6	Ring	6	Blue/Red
7	Tip	32	Red/Orange
7	Ring	7	Orange/Red
8	Tip	33	Red/Green
8	Ring	8	Green/Red
9	Tip	34	Red/Brown
9	Ring	9	Brown/Red
10	Tip	35	Red/Slate
10	Ring	10	Slate/Red
11	Tip	36	Black/Blue
11	Ring	11	Blue/Black
12	Tip	37	Black/Orange
12	Ring	12	Orange/Black
13	Tip	38	Black/Green
13	Ring	13	Green/Black
14	Tip	39	Black/Brown
14	Ring	14	Brown/Black
15	Tip	40	Black/Slate
15	Ring	15	Slate/Black
16	Tip	41	Yellow/Blue
16	Ring	16	Blue/Yellow
17	Tip	42	Yellow/Orange
17	Ring	17	Orange/Yellow

Port	Designation	Pin	Cable Color
18	Tip	43	Yellow/Green
18	Ring	18	Green/Yellow
19	Tip	44	Yellow/Brown
19	Ring	19	Brown/Yellow
20	Tip	45	Yellow/Slate
20	Ring	20	Slate/Yellow
21	Tip	46	Violet/Blue
21	Ring	21	Blue/Violet
22	Tip	47	Violet/Orange
22	Ring	22	Orange/Violet
23	Tip	48	Violet/Green
23	Ring	23	Green/Violet
24	Tip	49	Violet/Brown
24	Ring	24	Brown/Violet
—	Tip	50	Violet/Slate
—	Ring	25	Slate/Violet

ShoreGear 90BRI RJ-21X Telephone and Trunk Connector

1



50

Port	Designation	Pin	Cable Color
—	Tip	26	White/Blue
—	Ring	1	Blue/White
—	Tip	27	White/Orange
—	Ring	2	Orange/White
—	Tip	28	White/Green
—	Ring	3	Green/White
—	Tip	29	White/Brown
—	Ring	4	Brown/White
—	Tip	30	White/Slate
—	Ring	5	Slate/White
—	Tip	31	Red/Blue
—	Ring	6	Blue/Red
—	Tip	32	Red/Orange
—	Ring	7	Orange/Red
—	Tip	33	Red/Green
—	Ring	8	Green/Red
—	Tip	34	Red/Brown
—	Ring	9	Brown/Red
—	Tip	35	Red/Slate
—	Ring	10	Slate/Red
—	Tip	36	Black/Blue
—	Ring	11	Blue/Black
—	Tip	37	Black/Orange
—	Ring	12	Orange/Black
—	Tip	38	Black/Green
—	Ring	13	Green/Black
—	Tip	39	Black/Brown
—	Ring	14	Brown/Black
—	Tip	40	Black/Slate
—	Ring	15	Slate/Black
—	Tip	41	Yellow/Blue
—	Ring	16	Blue/Yellow
17	Tip	42	Yellow/Orange
17	Ring	17	Orange/Yellow

Port	Designation	Pin	Cable Color
18	Tip	43	Yellow/Green
18	Ring	18	Green/Yellow
19	Tip	44	Yellow/Brown
19	Ring	19	Brown/Yellow
20	Tip	45	Yellow/Slate
20	Ring	20	Slate/Yellow
21	Tip	46	Violet/Blue
21	Ring	21	Blue/Violet
22	Tip	47	Violet/Orange
22	Ring	22	Orange/Violet
23	Tip	48	Violet/Green
23	Ring	23	Green/Violet
24	Tip	49	Violet/Brown
24	Ring	24	Brown/Violet
—	Tip	50	Violet/Slate
—	Ring	25	Slate/Violet

ShoreGear-60/12 RJ-21X Telephone and Trunk Connector



Port	Designation	Pin	Cable Color
1	Tip	26	White/Blue
1	Ring	1	Blue/White
2	Tip	27	White/Orange
2	Ring	2	Orange/White
3	Tip	28	White/Green
3	Ring	3	Green/White
4	Tip	29	White/Brown
4	Ring	4	Brown/White
5	Tip	30	White/Slate
5	Ring	5	Slate/White
6	Tip	31	Red/Blue
6	Ring	6	Blue/Red
7	Tip	32	Red/Orange

Port	Designation	Pin	Cable Color
7	Ring	7	Orange/Red
8	Tip	33	Red/Green
8	Ring	8	Green/Red
9	Tip	34	Red/Brown
9	Ring	9	Brown/Red
10	Tip	35	Red/Slate
10	Ring	10	Slate/Red
11	Tip	36	Black/Blue
11	Ring	11	Blue/Black
12	Tip	37	Black/Orange
12	Ring	12	Orange/Black
—	Tip	38	Black/Green
—	Ring	13	Green/Black
—	Tip	39	Black/Brown
—	Ring	14	Brown/Black
—	Tip	40	Black/Slate
—	Ring	15	Slate/Black
—	Tip	41	Yellow/Blue
—	Ring	16	Blue/Yellow
—	Tip	42	Yellow/Orange
—	Ring	17	Orange/Yellow
—	Tip	43	Yellow/Green
—	Ring	18	Green/Yellow
—	Tip	44	Yellow/Brown
—	Ring	19	Brown/Yellow
—	Tip	45	Yellow/Slate
—	Ring	20	Slate/Yellow
—	Tip	46	Violet/Blue
—	Ring	21	Blue/Violet
—	Tip	47	Violet/Orange
—	Ring	22	Orange/Violet
—	Tip	48	Violet/Green
—	Ring	23	Green/Violet
—	Tip	49	Violet/Brown
—	Ring	24	Brown/Violet
—	Tip	50	Violet/Slate
—	Ring	25	Slate/Violet

ShoreGear-60/12 RJ-21X Telephone and Trunk Connector with Converter Patch Cable



A converter patch cable is included with each ShoreGear-60/12 to conform with existing cabling standards.

Port	Designation	Pin	Cable Color
1	Tip	26	White/Blue
1	Ring	1	Blue/White
—	Tip	27	White/Orange
—	Ring	2	Orange/White
2	Tip	28	White/Green
2	Ring	3	Green/White
—	Tip	29	White/Brown
—	Ring	4	Brown/White
3	Tip	30	White/Slate
3	Ring	5	Slate/White
—	Tip	31	Red/Blue
—	Ring	6	Blue/Red
4	Tip	32	Red/Orange
4	Ring	7	Orange/Red
—	Tip	33	Red/Green
—	Ring	8	Green/Red
5	Tip	34	Red/Brown
5	Ring	9	Brown/Red
—	Tip	35	Red/Slate
—	Ring	10	Slate/Red
6	Tip	36	Black/Blue
6	Ring	11	Blue/Black
—	Tip	37	Black/Orange
—	Ring	12	Orange/Black
7	Tip	38	Black/Green
7	Ring	13	Green/Black
—	Tip	39	Black/Brown
—	Ring	14	Brown/Black
8	Tip	40	Black/Slate
8	Ring	15	Slate/Black
—	Tip	41	Yellow/Blue
—	Ring	16	Blue/Yellow

Port	Designation	Pin	Cable Color
9	Tip	42	Yellow/Orange
9	Ring	17	Orange/Yellow
—	Tip	43	Yellow/Green
—	Ring	18	Green/Yellow
10	Tip	44	Yellow/Brown
10	Ring	19	Brown/Yellow
—	Tip	45	Yellow/Slate
—	Ring	20	Slate/Yellow
11	Tip	46	Violet/Blue
11	Ring	21	Blue/Violet
—	Tip	47	Violet/Orange
—	Ring	22	Orange/Violet
12	Tip	48	Violet/Green
12	Ring	23	Green/Violet
—	Tip	49	Violet/Brown
—	Ring	24	Brown/Violet
—	Tip	50	Violet/Slate
—	Ring	25	Slate/Violet

ShoreGear 50 RJ-21X Telephone and Trunk Connector

1



50

Port	Designation	Pin	Cable Color
1	Tip	26	White/Blue
1	Ring	1	Blue/White
2	Tip	27	White/Orange
2	Ring	2	Orange/White
3	Tip	28	White/Green
3	Ring	3	Green/White
4	Tip	29	White/Brown
4	Ring	4	Brown/White
5	Tip	30	White/Slate
5	Ring	5	Slate/White
6	Tip	31	Red/Blue
6	Ring	6	Blue/Red
7	Tip	32	Red/Orange
7	Ring	7	Orange/Red
8	Tip	33	Red/Green
8	Ring	8	Green/Red
9	Tip	34	Red/Brown
9	Ring	9	Brown/Red
10	Tip	35	Red/Slate
10	Ring	10	Slate/Red
11	Tip	36	Black/Blue
11	Ring	11	Blue/Black
12	Tip	37	Black/Orange
12	Ring	12	Orange/Black
13	Tip	38	Black/Green
13	Ring	13	Green/Black
14	Tip	39	Black/Brown
14	Ring	14	Brown/Black
15	Tip	40	Black/Slate
15	Ring	15	Slate/Black
16	Tip	41	Yellow/Blue
16	Ring	16	Blue/Yellow
17	Tip	42	Yellow/Orange
17	Ring	17	Orange/Yellow

Port	Designation	Pin	Cable Color
18	Tip	43	Yellow/Green
18	Ring	18	Green/Yellow
19	Tip	44	Yellow/Brown
19	Ring	19	Brown/Yellow
20	Tip	45	Yellow/Slate
20	Ring	20	Slate/Yellow
21	Tip	46	Violet/Blue
21	Ring	21	Blue/Violet
22	Tip	47	Violet/Orange
22	Ring	22	Orange/Violet
23	Tip	48	Violet/Green
23	Ring	23	Green/Violet
24	Tip	49	Violet/Brown
24	Ring	24	Brown/Violet
—	Tip	50	Violet/Slate
—	Ring	25	Slate/Violet

ShoreGear-40/8 RJ-21X Telephone and Trunk Connector



Port	Designation	Pin	Cable Color
—	Tip	26	White/Blue
—	Ring	1	Blue/White
—	Tip	27	White/Orange
—	Ring	2	Orange/White
—	Tip	28	White/Green
—	Ring	3	Green/White
—	Tip	29	White/Brown
—	Ring	4	Brown/White
1	Tip	30	White/Slate
1	Ring	5	Slate/White
2	Tip	31	Red/Blue
2	Ring	6	Blue/Red
3	Tip	32	Red/Orange

Port	Designation	Pin	Cable Color
3	Ring	7	Orange/Red
4	Tip	33	Red/Green
4	Ring	8	Green/Red
5	Tip	34	Red/Brown
5	Ring	9	Brown/Red
6	Tip	35	Red/Slate
6	Ring	10	Slate/Red
7	Tip	36	Black/Blue
7	Ring	11	Blue/Black
8	Tip	37	Black/Orange
8	Ring	12	Orange/Black
—	Tip	38	Black/Green
—	Ring	13	Green/Black
—	Tip	39	Black/Brown
—	Ring	14	Brown/Black
—	Tip	40	Black/Slate
—	Ring	15	Slate/Black
—	Tip	41	Yellow/Blue
—	Ring	16	Blue/Yellow
—	Tip	42	Yellow/Orange
—	Ring	17	Orange/Yellow
—	Tip	43	Yellow/Green
—	Ring	18	Green/Yellow
—	Tip	44	Yellow/Brown
—	Ring	19	Brown/Yellow
—	Tip	45	Yellow/Slate
—	Ring	20	Slate/Yellow
—	Tip	46	Violet/Blue
—	Ring	21	Blue/Violet
—	Tip	47	Violet/Orange
—	Ring	22	Orange/Violet/Violet
—	Tip	48	Violet/Green
—	Ring	23	Green/Violet
—	Tip	49	Violet/Brown
—	Ring	24	Brown/Violet
—	Tip	50	Violet/Slate
—	Ring	25	Slate/Violet

ShoreGear-40/8 RJ-21X Telephone and Trunk Connector with Patch Cable



50

A converter patch cable is included with each ShoreGear-40/8 to conform with existing cabling standards.

Port	Designation	Pin	Cable Color
1	Tip	26	White/Blue
1	Ring	1	Blue/White
—	Tip	27	White/Orange
—	Ring	2	Orange/White
2	Tip	28	White/Green
2	Ring	3	Green/White
—	Tip	29	White/Brown
—	Ring	4	Brown/White
3	Tip	30	White/Slate
3	Ring	5	Slate/White
—	Tip	31	Red/Blue
—	Ring	6	Blue/Red
4	Tip	32	Red/Orange
4	Ring	7	Orange/Red
—	Tip	33	Red/Green
—	Ring	8	Green/Red
5	Tip	34	Red/Brown
5	Ring	9	Brown/Red
—	Tip	35	Red/Slate
—	Ring	10	Slate/Red
6	Tip	36	Black/Blue
6	Ring	11	Blue/Black
—	Tip	37	Black/Orange
—	Ring	12	Orange/Black
7	Tip	38	Black/Green
7	Ring	13	Green/Black
—	Tip	39	Black/Brown
—	Ring	14	Brown/Black
8	Tip	40	Black/Slate
8	Ring	15	Slate/Black
—	Tip	41	Yellow/Blue
—	Ring	16	Blue/Yellow

Port	Designation	Pin	Cable Color
—	Tip	42	Yellow/Orange
—	Ring	17	Orange/Yellow
—	Tip	43	Yellow/Green
—	Ring	18	Green/Yellow
—	Tip	44	Yellow/Brown
—	Ring	19	Brown/Yellow
—	Tip	45	Yellow/Slate
—	Ring	20	Slate/Yellow
—	Tip	46	Violet/Blue
—	Ring	21	Blue/Violet
—	Tip	47	Violet/Orange
—	Ring	22	Orange/Violet
—	Tip	48	Violet/Green
—	Ring	23	Green/Violet
—	Tip	49	Violet/Brown
—	Ring	24	Brown/Violet
—	Tip	50	Violet/Slate
—	Ring	25	Slate/Violet

ShoreGear 220T1A RJ-21X Telephone and Trunk Connector

1



50

Port	Designation	Pin	Cable Color
1	Tip	26	White/Blue
1	Ring	1	Blue/White
2	Tip	27	White/Orange
2	Ring	2	Orange/White
3	Tip	28	White/Green
3	Ring	3	Green/White
4	Tip	29	White/Brown
4	Ring	4	Brown/White
5	Tip	30	White/Slate
5	Ring	5	Slate/White
6	Tip	31	Red/Blue
6	Ring	6	Blue/Red
7	Tip	32	Red/Orange
7	Ring	7	Orange/Red
8	Tip	33	Red/Green
8	Ring	8	Green/Red
9	Tip	34	Red/Brown
9	Ring	9	Brown/Red
10	Tip	35	Red/Slate
10	Ring	10	Slate/Red
11	Tip	36	Black/Blue
11	Ring	11	Blue/Black
12	Tip	37	Black/Orange
12	Ring	12	Orange/Black
13	Tip	38	Black/Green
13	Ring	13	Green/Black
14	Tip	39	Black/Brown
14	Ring	14	Brown/Black
15	Tip	40	Black/Slate
15	Ring	15	Slate/Black
16	Tip	41	Yellow/Blue
16	Ring	16	Blue/Yellow
17	Tip	42	Yellow/Orange

Port	Designation	Pin	Cable Color
17	Ring	17	Orange/Yellow
18	Tip	43	Yellow/Green
18	Ring	18	Green/Yellow
19	Tip	44	Yellow/Brown
19	Ring	19	Brown/Yellow
20	Tip	45	Yellow/Slate
20	Ring	20	Slate/Yellow
21	Tip	46	Violet/Blue
21	Ring	21	Blue/Violet
22	Tip	47	Violet/Orange
22	Ring	22	Orange/Violet
23	Tip	48	Violet/Green
23	Ring	23	Green/Violet
24	Tip	49	Violet/Brown
24	Ring	24	Brown/Violet
—	Tip	50	Violet/Slate
—	Ring	25	Slate/Violet

RJ-11 Telephone and Trunk Connector

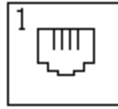

Pin	Designation
1	—
2	—
3	Tip
4	Ring
5	—
6	—

RJ-45 LAN Connector

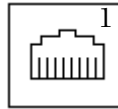

Pin	Designation
1	TX+
2	TX-
3	RX+
4	—
5	—
6	RX-
7	—
8	—

3mm Stereo Audio Input Connector for Music on Hold

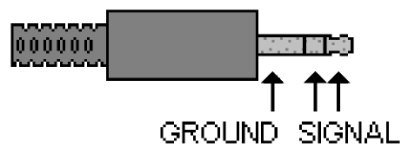

3mm Stereo Audio Output Connector for Paging/Nightbell

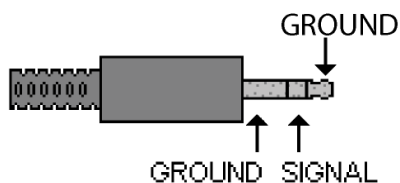

NOTE Due to a physical connector issue in the ShoreGear switch, using a mono jack causes issues when plugged into the Paging/Nightbell port. This issue can be corrected using a special stereo jack. See below for details.

To correct this issue, use a modified stereo jack. You can either hardwire such a jack or purchase one at an electronics store.

If you will be hardwiring the jack yourself, follow the upper of the two illustrations shown below by connecting the audio to the “Ring” (center connection) and the ground to the “Ground” connector. We highly recommend soldering the connections together to prevent audio quality issues.

If you wish to purchase such a connector that has been pre-made, just make sure to request one that can convert mono to stereo, as shown in the lower of the two illustrations.

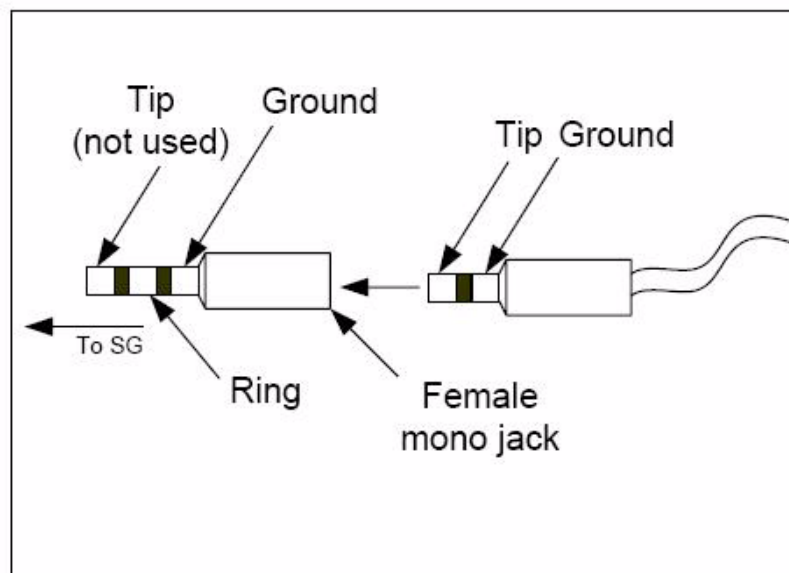
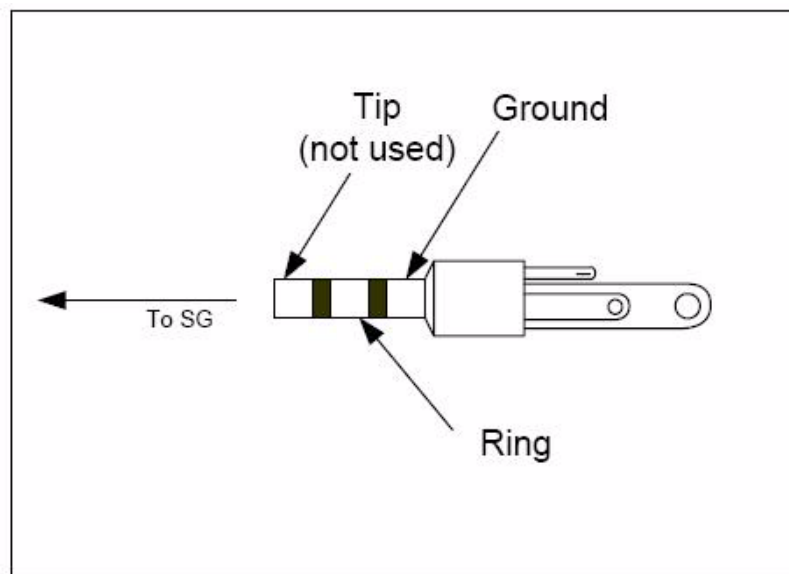

RJ-48C T1/E1 and T1/E1 Monitor Connectors

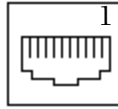

Pin	Designation
1	RX Ring
2	RX Tip
3	—
4	TX Ring
5	TX Tip
6	—
7	—
8	—

NOTE When connecting the ShoreGear-T1 or ShoreGear-E1 to a legacy PBX, you must use a crossover cable between the two systems.

DB-9 Maintenance Connector

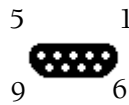

Pin	Designation
1	—
2	TX Data
3	RX Data
4	DSR
5	GND
6	DTR
7	CTS
8	RTS
9	—

Headset Jack Connector (IP530/560)



1 2 3 4

Pin	Designation
1	3.3 V
2	TX to speaker
3	RX from microphone
4	Ground

Legacy Integration

ShoreTel 7.5 provides a migration solution from a legacy TDM-based voice network into the voice-over-IP ShoreTel 7.5 system. You can handle line growth and enable a migration of users from the legacy system to the ShoreTel 7.5 IP PBX by deploying the ShoreTel 7.5 system at one location in a multi-location enterprise, or side-by-side with a legacy PBX at a single location.

Integrating the ShoreTel 7.5 system with your legacy PBX's allows users on the different systems to communicate with each other effectively for both phone calls and using voice mail.

With an integrated voice network, you can:

- Simplify communications for your users with an enterprise-wide coordinated dialing plan using extension dialing.
- Exchange voice mail messages between users on different sites using different voice mail systems. Standard commands such as compose, forward, and replay extend the value of your different voice mail systems.
- Consolidate trunks with different traffic types to leverage different service provider rates.
- Reduce service costs by redirecting inter-site calls across your IP network.

Checklist

Review the following topics before proceeding to the next chapter:

Task Description	See
<input type="checkbox"/> Coordinated Dialing	page 14-2
<input type="checkbox"/> Trunk Requirements	page 14-4
<input type="checkbox"/> Coordinated Dialing Plan	page 14-4
<input type="checkbox"/> PSTN Services	page 14-5
<input type="checkbox"/> Multi-Site Integration	page 14-5
<input type="checkbox"/> Single Site Integration	page 14-5

Task Description	See
<input type="checkbox"/> Consolidated Long Distance	page 14-6
<input type="checkbox"/> Voice Mail Integration	page 14-6
<input type="checkbox"/> System Requirements	page 14-28
<input type="checkbox"/> Connection Cable	page 14-28
<input type="checkbox"/> Administration and Configuration	page 14-29
<input type="checkbox"/> Trunk Configuration	page 14-30

Introduction

A digital trunk “tie” line integrates the ShoreTel 7.5 system with a legacy PBX. The connection is between the legacy system’s T1/PRI interface and the T1/PRI interface of a ShoreGear-T1 located anywhere in your IP network.

There are four different types of activities that occur on the interface.

- Calls from ShoreTel 7.5 users or applications to an extension located on the other system are routed across the tie trunk. When a call is placed, the trunk is accessed and the ShoreTel 7.5 system sends the configured number of digits to the PBX identifying the called extension.
- Calls from users on the legacy system or from trunks, or other applications on the legacy PBX, are routed across this interface. When the legacy user places their call, the legacy system accesses the trunk and then sends the digits as DNIS.
- Outbound calls from users or applications on the ShoreTel 7.5 system can be routed across the trunk to the legacy PBX. When a call is placed, the trunk access code or trunk configuration of the connection to the legacy PBX indicates the outbound call is to be placed to the PBX.
- Calls between the ShoreTel 7.5 and legacy system's voice mail applications are carried across the trunk connecting the two systems. The voice mail systems make calls to configured destinations on the other system to send voice mail messages to users on the other system.

NOTE A tie trunk is not required to enable voice mail or AMIS integration. The two voice mail systems can communicate by dialing each other via the PSTN. In general, when a tie trunk is in place, AMIS calls should be routed via the trunk to reduce PSTN costs.

The connection between the two systems can be provided by either T1 trunks or by a PRI interface. ShoreTel recommends that you use PRI to enable calling number information exchanges between the two systems.

Coordinated Dialing

Coordinated dialing allows users to dial between the systems using extension-to-extension dialing as well as enabling consolidation of inbound and outbound services. To effectively plan the integration, consider the following items:

- Expected call traffic between the two systems to provide sufficient trunking
- Current numbers of extensions and extension lengths at both systems

- Service plans to determine which PSTN services are provided at which voice system
- The type of legacy PBX equipment integrated with the ShoreTel 7.5 system

Trunk Requirements

The number of digital trunks required between the ShoreTel 7.5 system and the legacy PBX depends on the expected traffic between the two systems. To determine the number of trunks, you need to estimate the number of calls per hour that are placed between the two systems. When estimating the call volume between the two systems, consider the following:

- The volume of direct calls between users on the two systems
- Traffic related to Automated Call Distributor (ADC) calls
- Outbound call volume (i.e. when outbound trunking to the PSTN is provided by one of the systems for all users, such as a PSTN trunk connected to the legacy PBX that provides long distance services for users on both the legacy and ShoreTel 7.5 system)
- Inbound call volume (i.e. when inbound services are provided by one system to all users)

Additionally, you can rely on the estimated calls-per-hour number to determine the number of trunks to configure between the two systems.

For more information on trunk requirements, see Chapter 5, “Trunk Planning and Ordering.”

Coordinated Dialing Plan

With legacy integration, users on both systems can dial one another using abbreviated or extension dialing. This includes dialing from applications on the systems, such as the ShoreTel 7.5 voice mail application, and would also include forwarding a call to an assistant at an extension on the legacy PBX. To determine the coordinated dialing plan configuration, you must identify the current numbering of users on both systems. For example:

- When the systems are located together, extensions can normally be assigned from a single numbering plan, or from a single DID number range provided by the local carrier. In this case, the extensions on the two systems are assigned such that there is no overlap using the desired extension length.
- When systems are at different locations, each system’s numbering plan is often based on the DID range supplied by the local telephone company. In this case, overlap of the extension ranges can occur at the currently used extension length.

For example, consider the following situation.

- One location is assigned DID range 408-555-2000 through 2999
- The second location is assigned range 650-333-2500 through 2799
- The systems currently use four-digit dialing matching the trailing 4 digits of the DID numbers.

In this case, there are users on both systems currently assigned extension 2500. To provide a coordinated dialing plan across the systems, the extensions must be adjusted to make them unique system-wide. In the integration, four-digit extensions that overlap are made unique by increasing the extension length across the system. When the extension length is increased, the first digit becomes the “system” number and the remaining digits are the “extension.” In the above example, the extension length would be increased to five-digit dialing, and at the first location would be extensions 52000

through 52999, while users at the second location would be assigned extensions 32500 through 32799.

NOTE The extensions on all systems that are integrated together should be configured to be the same length.

Be sure to document the planned integrated dialing plan prior to configuring the systems to streamline the configuration process. Information to take note of is provided in the following template:

	System One	System Two
Location		
DID Range		
Local Extensions (Prefix + Number)		
Remote Extensions (Prefix + Number)		

PSTN Services

The number of trunks, your integration plan, and the overall system design includes the provisioning of services across the network. PSTN services can be provided at both systems in the integration or consolidated together on one system.

Multi-Site Integration

When the systems are located at different sites, both systems should have local trunking for both inbound and outbound calls. Local inbound numbers make it easy for nearby customers to reach you, while local outbound trunks allow you to save on telephone charges by using local services at the site.

In this configuration, the trunk lines connecting the systems are used for the inter-site calling between extensions or applications on the two systems. The interfaces on the two systems are configured to dial out to the remote or off-system extensions, and to accept incoming calls using DNIS.

The ShoreGear-T1, ShoreGear 220T1/E1/T1A voice switch that connects to the legacy PBX should be located at the site with the legacy PBX. This leverages the IP network to extend the calls to the other sites with the ShoreTel 7.5 system.

Single Site Integration

When the systems are located at the same site, it is not required that both systems be connected to the PSTN. The systems can be configured to best match your requirements.

In a single site configuration, the PSTN connections for inbound calls can be connected to each system. In this environment, the trunks connecting the two systems are

configured to dial out the remote or off-system extensions and to accept incoming calls using DNIS.

Alternatively, inbound services can be consolidated on either the ShoreTel 7.5 system or the legacy PBX. In this environment, calls to users on the other systems are forwarded to the remote or off-system extensions through the trunk lines connecting the systems.

When all inbound trunks are consolidated on the ShoreTel 7.5 system, the trunks are configured to support off-system extensions within the range of extensions on the other PBX.

When all inbound trunks are configured on the legacy PBX, the trunks on the ShoreTel 7.5 system are configured to support inbound services with call routing to the extensions on the ShoreTel 7.5 system.

NOTE When DID numbers are already in place on one of the PBX's which will be connected, ShoreTel recommends that the inbound DID service not be moved or split between the systems but configured to remain on the system where they are currently configured and have calls to users on the other system forward across the connecting trunks.

In the single site configuration, ShoreTel recommends that services for outbound calls be connected to the legacy PBX. In this configuration the trunk interfaces on the ShoreTel 7.5 system are configured to support outbound local and long distance dialing while the interface on the PBX is configured to route the received outbound calls.

Consolidated Long Distance

Long distance calls can be consolidated into a single PSTN interface across both the ShoreTel 7.5 system and the integrated legacy PBX. In this configuration, you gain the benefits of reduced long distance rates by consolidating all your enterprise's long distance calls into a single carrier. When it is required, the outbound long distance trunks are connected to the legacy PBX and the ShoreTel 7.5 system is configured to route long distance calls outbound across the digital trunk connecting the systems.

Voice Mail Integration

The primary issue with voice mail integration is they are often proprietary and the interfaces defined to connect the same and disparate systems are very old, complex and difficult to implement. In fact, many voice systems from the same vendor are not connected. The interface with which most customers are familiar is AMIS. This is an analog interface that has been around for a long time, but is a real challenge to implement and can be very expensive from legacy voice mail providers. It is not uncommon to pay \$10,000 per site for this capability. Another widely-used interface, Simplified Message Desk Interface (SMDI), was developed in the days when the PBX and voice mail systems were separate systems. It operates on a serial link between a PBX and voice mail system and allows them to work together. ShoreTel 7.5 supports both AMIS and SMDI protocols for voice mail integration.

AMIS Protocol Support

The ShoreTel 7.5 system sends and receives voice mail messages to and from legacy voice mail systems using AMIS protocol Version 1 - Specification February 1992. To send voice mail messages to remote AMIS sites, ShoreTel 7.5 dials the access phone

number for the remote system. Likewise, to receive voice messages from a remote system, the remote system must know the number to dial into the ShoreTel 7.5 system. To reach the ShoreTel 7.5 system, the remote system must be configured to dial any number that reaches an auto-attendant menu.

AMIS call support is enabled by default. Incoming AMIS voice mail is delivered in the same manner as other voice mail; however, users cannot send replies. To send outbound AMIS voice mail, you must define AMIS System profiles in ShoreWare Director.

ShoreTel 7.5 negotiates the setup, handshaking, and teardown of AMIS system calls. Each voice mail requires a call over the trunk group defined for the AMIS delivery and call-back numbers.

To simplify AMIS systems and increase usability:

- Use the same extension length across your enterprise.
- Use off-system extensions to match remote users' mail boxes with their extension numbers.
- Assign each system a System ID to identify the remote site location

For more information on AMIS systems, see the *ShoreTel 7.5 Administration Guide*.

SMDI Protocol Support

The ShoreTel 7.5 product supports the SMDI protocol, enabling seamless integration of ShoreTel equipment with legacy phone systems and enabling a smooth migration toward an all-IP telephony solution.

A little history

The SMDI protocol evolved at a time when voice mail services and PBX services were provided by separate physical devices. Over the years, manufacturers have managed to offer both PBX and voice mail services within a single device, and the need for SMDI has diminished. However, the protocol can still be useful in situations where newer equipment will be integrated into a network of older devices.

How it works

SMDI enables the separate devices that provide PBX and voice mail services to share information over an out-of-band serial cable connection. The PBX shares information with the voice mail system about incoming calls. The following information is passed to the voice mail system:

- who the call is from
- where the call is going (i.e. user extension)
- the reason the call is going to voice mail instead of being answered

In response, the voice mail system returns a notification to the PBX that a message was left on the voice mail server. The PBX system then uses this information to alert the user by turning on the “message waiting” light on his or her phone.

Configurations of integrated equipment

With SMDI support, there are essentially two possible ways the ShoreTel and legacy equipment can be configured:

External Voice Mail Configuration – The legacy system provides voice mail services while the ShoreTel 7.5 system acts as the PBX.

ShoreTel Voice Mail Configuration – The ShoreTel system provides voice mail services while the legacy system acts as the PBX.

Additional details

A group of analog trunks from the ShoreTel system is used to access the legacy voice mail system (the ShoreTel system is on the extension side of the trunks). The ShoreTel voice mail application manages the group of outgoing extensions. The ShoreTel server can provide digit translations if the legacy voice mail and ShoreTel system have different extension lengths.

Figure 14-1 shows the ShoreTel system providing PBX services and the legacy equipment providing voice mail services.

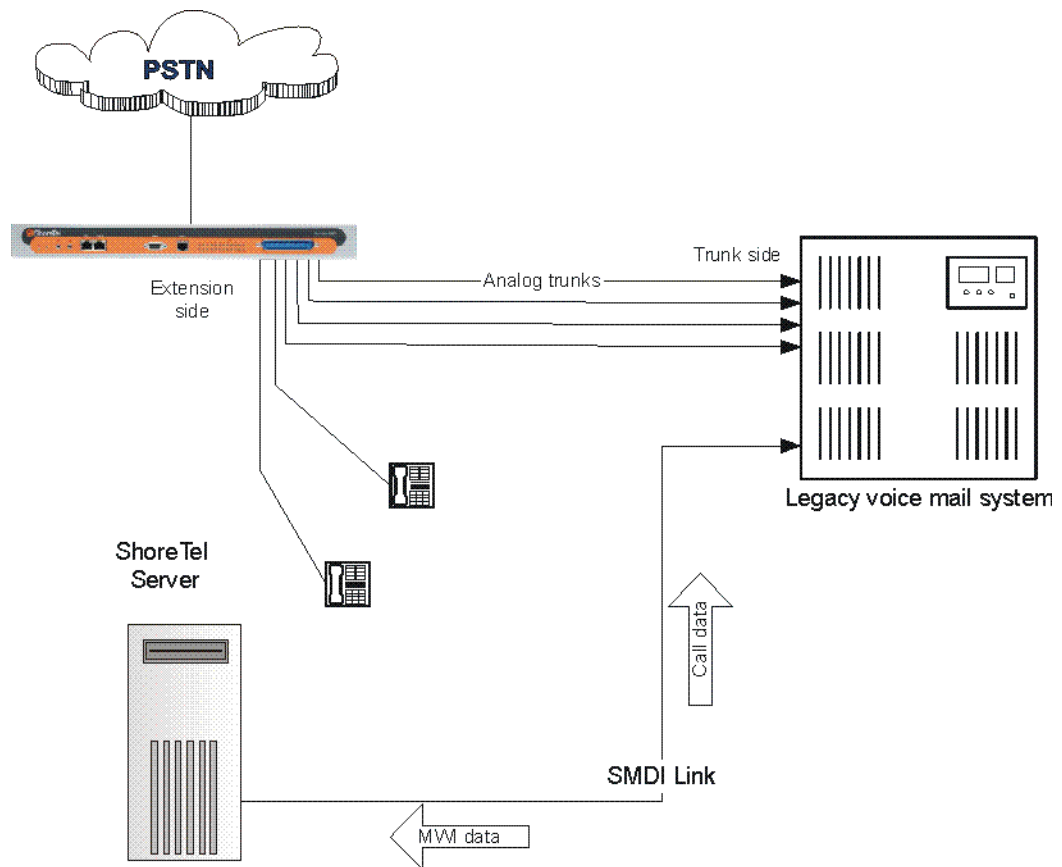

Figure 14-1 External Voice Mail with ShoreTel as PBX

Figure 14-2 below shows the legacy system providing PBX services and the ShoreTel equipment providing voice mail services.

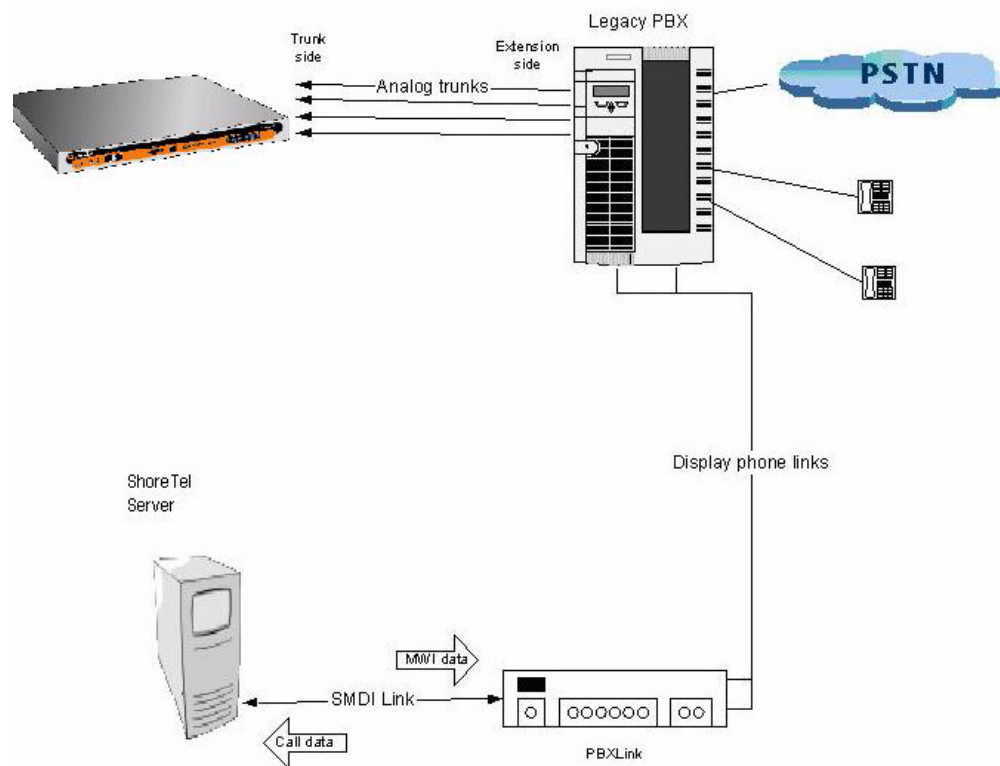

Figure 14-2 ShoreTel Voice Mail with legacy PBX

Details

- Figure 14-2 shows a ShoreTel switch connected to a legacy PBX through several analog trunks. These phone lines carry voice information from the PBX to the voice mail server. Signaling information is carried out-of-band on the separate serial line (near the bottom of the illustration).
- A ShoreTel voice mail server is connected through a serial cable to a PBX link device. (The PBX link device provides the basic SMDI services that were not included in some of the older legacy PBX devices. This device must be purchased separately and configured per the manufacturer's instructions.)
- The ShoreTel server and PBX link exchange information. The PBX link sends call data to the ShoreTel voice mail server, and the call data contains information related to the source and destination of the phone call, and provides information about why the call is going to voice mail (e.g. user did not answer, line was busy, etc.).
- The ShoreTel server, in return, sends MWI (Message Waiting Indicator) information that is used by the legacy PBX to turn on the message-waiting mechanism on a user's phone to let her know she has received a message.

Information Transferred via SMDI

The COM port is used to send call information between the ShoreTel system and the legacy voice mail system. The SMDI protocol transmits the following call information from the ShoreTel system to the legacy system:

- Message desk number: 1-999
- Logical Terminal number (terminal identifier): 1-9999
- Call type (All, Busy, Direct, No Answer, Unknown)
- Called party
- Calling party

The SMDI MWI protocol transmits the following information from the legacy voice mail system to the ShoreTel system:

- Message waiting indication control
- Extension
- On/Off indication

Configuring Legacy Voice Mail Integration Using SMDI

As mentioned before, there are two modes of operation with respect to integrating a ShoreTel system and a legacy system:

- *External Voice Mail Configuration* - In this configuration, the legacy system provides voice mail services while the ShoreTel system acts as PBX for users.
- *ShoreTel Voice Mail Configuration* - In this configuration, the ShoreTel system provides voice mail services while the legacy system acts as a PBX for users.

The former of these two operational modes (External voice mail) is discussed below, while the procedure for the latter configuration (ShoreTel voice mail) follows in “Configuring ShoreTel Voice Mail Integration Using SMDI” on page 14-19.

To integrate a legacy voice mail system with ShoreTel 7.5, you need to perform the following basic tasks:

- Configure the server’s COM port for SMDI connections to the legacy system.
- Configure interface options from ShoreWare Director.
- Create a user group for users with access to the integration extensions.

COM Port Setup

To establish the SMDI link between the ShoreTel server and the legacy voice mail system, connect one end of a DB-9 serial cable to the COM port on the ShoreTel server and the other end of the cable to a COM port on the legacy voice mail server.

The COM port settings on the ShoreTel server must match the settings of the COM port on the legacy voice mail server. Obtain the legacy voice mail COM port settings from the legacy voice mail server’s administration guide or from your system integration manager. You need the following information:

- Baud rate
- Data bits
- Parity
- Stop bits
- Flow control

To configure COM port communication:

- Step 1** From the **Start** menu on the Windows server connected to the legacy voice mail server, select **Settings**, and then **Control Panel**.
- Step 2** In the **Control Panel**, open the **Computer Management** folder.
- Step 3** Open the **Device Manager**.
- Step 4** From the right pane in the window, expand the item **Ports (COM & LTP)**.
- Step 5** Right-click the COM port used to connect the ShoreTel server and legacy voice mail system, and select **Properties** from the menu.

Ask your server administrator if you need help in determining the correct COM port.

- Step 6** In the **Properties** window, enter the settings for the legacy voice mail server COM port.
- Step 7** Click **OK** to save the settings.
- Step 8** In ShoreWare Director, open the Server edit page.
- Step 9** Enter the COM port the server will use for SMDI communications in the **COM Port (1-10)** text box.
- Step 10** Click **Save**.

NOTE The ShoreTel 7.5 system will not read the COM port settings until you have saved the changes to the Server edit page or until the voice mail service is restarted.

Analog Trunk Port Setup

The ShoreTel system sends calls to the legacy voice mail server over analog trunks connecting the two systems. The extensions are on the ShoreTel side, and the legacy voice mail system is the trunk side. The ShoreTel system sends calls made to these extensions to the legacy voice mail system when voice mail is needed. Before the call is sent, the SMDI protocol sends information about the call to the legacy voice mail system via the SMDI serial link. This allows the legacy voice mail system to handle the call correctly.

To configure the extensions, you need to do the following:

- Create a list of the extensions and include the Logical Terminal Number for each extension.
- Configure the extensions with a new dial number (DN) type and marked as private users with no mail box.
- Assign a physical port to each extension in Director. Configure the extensions to forward to the Backup Auto Attendant on “no answer” or “busy.”

Configuring the ShoreWare Server

Follow these steps to set up communication between ShoreWare Director and the legacy voice mail server.

To set up ShoreWare Director to communicate with the legacy voice mail server:

- Step 1** From **ShoreWare Director**, click **Servers** in the navigation frame.
- Step 2** Select the server connected to the legacy voice mail system.
- Step 3** In the **Edit Server** page under **Simplified Message Desk Interface**, change the settings as follows:
- a** Make sure that the **ShoreTel as PBX box** is selected.
 - b** In the **COM Port** field, enter the port on the server that will be used for SMDI communication.
 - c** In the **Message Desk Number** field, enter the Message Desk number (range is 1-999, with a default of 1). This number identifies

a specific voice mail system and must be set to the value the voice mail system expects. In configurations where a number of SMDI links are daisy chained together, this value is used to allow each system to know what data belongs to it. Since most systems use only one SMDI link, this parameter is normally set to 1.

- d In the **Number of Digits** field, enter the extension length. (range 2-32 digits). This value is used to determine how many digits the ShoreTel 7.5 system sends in SMDI extension fields. This value needs to be set to the value the voice mail system expects. The most common values are either 7 or 10. If the system extension length is less than the number of SMDI digits then the extension number will be padded. For example, if the ShoreTel 7.5 system needs to send extension 456 and the number of SMDI digits is set to 7, extension 0000456 is sent. If no padding is desired, the number of digits should be set to 2. In the above example with the number of SMDI digits set to 2 only 456 will be sent.
- e In the **Translation Table** field, select a translation table. Translation tables are created in ShoreWare Director. If you are using a translation table, make sure the **Use for Call Data** and **Use for MWI Data** check boxes are selected. For more information on building translation tables, see the *ShoreTel 7.5 Administration Guide*.
- f Click **Save**.

Digit Translation

If ShoreTel system extensions and legacy voice mail system extensions differ in length, you need to create digit translation tables that map the ShoreTel extensions to legacy system extensions. The digit translation tables must be added as a group of named tables from the Voice Mail section of ShoreWare Director. For more information see the *ShoreTel 7.5 Administration Guide*.

Table 14-1 shows a digit translation table mapping shorter ShoreTel extensions to longer legacy system extensions. For example, ShoreTel extensions in the range of 5xx will be in the 65xx range on the PBX, and the original digit “5” will be replaced by “65.”

Table 14-1 Digit Translation Mapping

Extension Mapping		Digit Translation Table	
ShoreTel	Legacy	Original Digits	Replacement Digits
5xx	65xx	5	65
3xx	73xx	3	73
2xx	83xx	2	83

Table 14-2 shows a digit translation table mapping longer ShoreTel extensions to shorter legacy system extensions. For example, ShoreTel extensions in the range of 75xx will be in sent. to extensions in the 3xx range on the legacy voice mail system, and the original digit “75” will be replaced by “3.”

Table 14-2 Digit Translation Mapping

Extension Mapping		Digit Translation Table	
ShoreTel	Legacy	Original Digits	Replacement Digits
65	5xx	65	5
66xx	6xx	66	6
75xx	3xx	75	3

Figure 14-3 illustrates how digit translation functions between the ShoreTel server and legacy voice system.

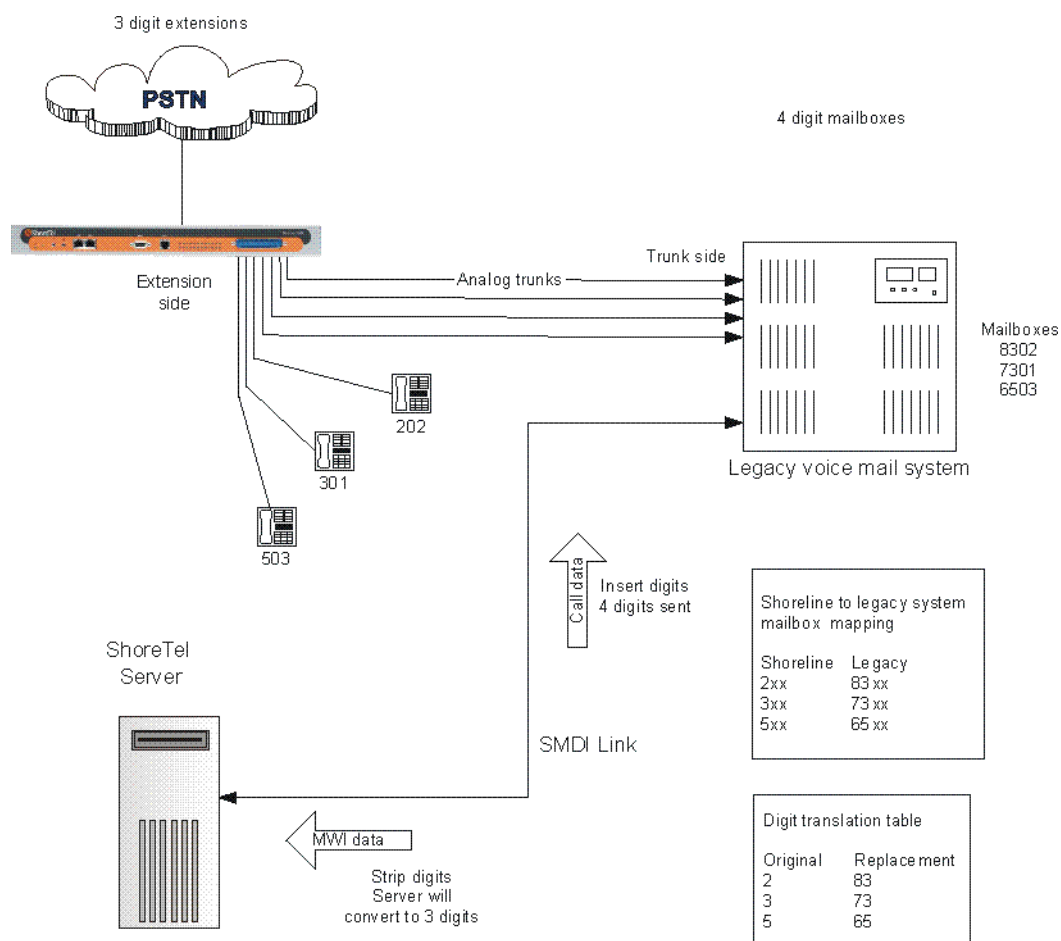

Figure 14-3 Mixed Extension Length SMDI Integration

To create a digit translation table, follow the procedure below:

- Step 1** Launch ShoreWare Director and enter the user ID and password.
- Step 2** Click on the **Administration** link to expand the list (if it has not already been expanded).
- Step 3** Click on the **System Parameters** link to expand the list.
- Step 4** Click on the **Digit Translation Tables** link.
- Step 5** Click the **New** button.
- Step 6** Enter a name in the **Name** field and click the **Save** button to store your digit translation table.
- Step 7** Click the **New** button again to display the **Digit Translation** window (below).

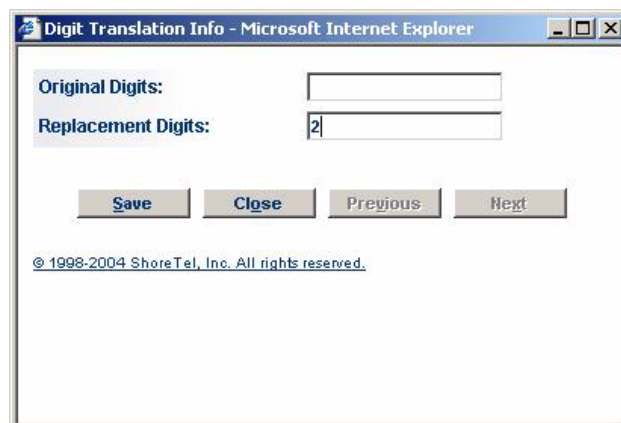

Figure 14-4 Leave Original Digits blank to add a digit to all legacy extensions

Next, you must select the digit translation mapping that you just created at the server.

Step 8 Click on the **Application Servers** link and click on the name of the ShoreTel server that will be handling the digit translation.

Step 9 In the Simplified Message Desk Interface section of the Application Servers window, select **ShoreTel Voice Mail** from the **Mode** drop-down menu.

Step 10 The **Translation Table** drop-down menu appears. Click on the arrow-button and select the name of the digit translation table that you just created.

Step 11 Select the **Use for Call Data** check box and **Use for MWI Data** check box by placing a check mark in each one (as shown below). Doing so allows for the digit translation to occur when:

- Data about a call is transferred between the legacy and ShoreTel systems.
- Message Waiting Indicator information is transferred between the two systems to notify the legacy PBX that a message was left on the ShoreTel voice mail.

Step 12 By default, the “Use Flash to Route Calls” check box is enabled. Leave this as is. Note that this check box only appears when “ShoreTel Voice Mail” is selected in the *Mode* drop-down menu in the *Simplified Message Desk Interface* section of the window. If selected, calls sent to the ShoreTel Auto Attendant from the SMDI trunk group are

automatically transferred to the dialed extension using flash. If not selected, calls will be routed using other lines.

NOTE The flash call routing function is only supported on the following switches: ShoreGear-40/8, ShoreGear 50, ShoreGear-60/12, ShoreGear 90, and ShoreGear-120/24.

NOTE The extension length must be the same on each of the systems for the “Transfer Using Flash” feature to work as no translation is applied.

Application Servers New Copy Save Delete Reset

Edit Server * mod

Edit this record Refresh this page

Name:

Host IP Address: Ping this Server

Site:

SoftSwitch Name:

Voice Mail and Auto Attendant

Voice Mail Extension:

Voice Mail Login Extension:

Auto Attendant Extension:

Assigned User Group:

Default Auto-Attendant Menu:

Simplified Message Desk Interface:

Mode:

Trunk Group:

COM Port (1 - 10):

Message Desk Number (1 - 999):

Number of Digits (2 - 32):

Translation Table:

Use for Call Data ←

Use for MWI Data ←

Use Flash to Route Calls ←

Figure 14-5 Enabling digit translation for MWI and call data, and flash routing

Step 13 Click the Save button to store your changes.

Setting Up the User Group in ShoreWare Director

Follow these steps to set up a user group for those users who will have their voice mail re-directed to the legacy voice mail system.

To set up the user group:

- Step 1** Open ShoreWare Director.
- Step 2** From the navigation frame, click **Users** and then **User Groups**.
- Step 3** Select an existing user group or create a new user group.
- Step 4** Change the **Simplified Message Desk Interface Mode** option to **ShoreTel as PBX** by selecting this setting from the drop-down menu.
- Step 5** Click **Save**.

Configuring ShoreTel Voice Mail Integration Using SMDI

As mentioned before, there are two modes of operation with respect to integrating a ShoreTel system and a legacy system:

- *External Voice Mail Configuration* - In this configuration, the legacy system provides voice mail services while the ShoreTel system acts as PBX for users.
- *ShoreTel Voice Mail Configuration* - In this configuration, the ShoreTel system provides voice mail services while the legacy system acts as a PBX for users.

The former of these two operational modes (External voice mail) is discussed in “Configuring Legacy Voice Mail Integration Using SMDI” on page 14-11. The procedure for the latter configuration (ShoreTel voice mail) follows.

Configuring the “ShoreTel Voice Mail Configuration” consists of the following major tasks:

- Creating a Trunk Group
- Creating Trunks
- Configuring the ShoreTel Server for SMDI
- Creating a User Group
- Adding an Individual User
- Configuring the Serial Connection
- Configuring Digit Translation Tables
- PBX link

Creating a Trunk Group

One of the first tasks involved in configuring SMDI is to create a trunk group. The trunk group is used to manage the individual trunk lines between the ShoreTel switch and the legacy PBX. Instructions for creating the trunk group are provided below. For additional details on setting up trunk groups, refer to the *ShoreTel 7.5 Administration Guide*.

To create a trunk group for SMDI trunks, follow the procedure below:

- Step 1** Launch ShoreWare Director and enter the user ID and password.
- Step 2** Click on the **Administration** link to expand the list (if it has not already been expanded).
- Step 3** Click on the **Trunks** link to expand the list.
- Step 4** Click on the **Trunk Groups** link to display the Trunk Groups window.
- Step 5** Select the trunk group site, and select **Analog Loop Start** for the type. Then click the **Go** link.
- Step 6** Enter a name for the trunk group in the **Name** field, as shown below.

Trunk Groups
 Edit Analog Loopstart Trunk Group

[New](#) [Copy](#) [Save](#) [Delete](#) [Reset](#) [Help](#)

[Edit this record](#) [Refresh this page](#) * modified

Name:

Site:

Language:

Inbound:

Destination: [Search](#)

Outbound:

Network Call Routing:

Access Code:

Local Area Code:

Additional Local Area Codes: [Edit](#)

Nearby Area Codes: [Edit](#)

Figure 14-6 Creating a trunk group

Step 7 Enter a voice mail extension in the **Inbound Destination** field to direct inbound calls to the ShoreTel Auto Attendant system.

Step 8 Click the **Save** button to store your changes.

Creating Trunks

After creating the trunk group, the next step is to create one or more trunk lines representing each data connection between the ShoreTel switch and the legacy PBX. The lines between the PBX and ShoreTel voice mail must be trunk lines with ShoreTel being the trunk side and the PBX being the extension side, (i.e. calls leaving the PBX for the voice mail system will leave on extensions). The PBX-to-voice mail connection might also be a T1 trunk that uses a channel bank to provide extensions to the legacy PBX.

To create a trunk line, follow the procedure below:

Step 1 With ShoreWare Director still open, click on the **Trunks** link to expand the list.

Step 2 Click on the **Individual Trunks** link.

Step 3 Select the trunk line site (i.e. Headquarters or Remote) from the drop-down menu, and use the drop-down menu to find and select the name of the trunk group you just created.

Step 4 Click the **Go** link to display the Edit Trunk window, similar to the one shown below.

Trunks
Edit Trunk

[New](#) [Copy](#) [Save](#) [Delete](#) [Reset](#) [Help](#)

* modified

Edit this record [Refresh this page](#)

Site:	Headquarters
Trunk Group:	SMDI Trunk Group
Number:	<input type="text" value="1"/>
Switch Port:	<input type="text" value="End Top Sg24 - 2"/>
Jack #:	<input type="text"/>

Figure 14-7 Creating a trunk line

- Step 5** In the **Number** field, enter the Logical Terminal Number. This value can range from 1 to 9999. For many systems the extension number of the port is used.

NOTE The Logical Terminal Number identifies the port the PBX will use to send the call to the ShoreTel voice mail system. It is very important that the LTN match what the PBX will send. You must check with your PBX vendor to determine what will be sent.

- Step 6** Click the **Save** button to store your changes.

Configuring the ShoreTel Server for SMDI

After creating the trunk lines, you will configure the ShoreTel voice mail server. Configuration involves setting up the various SMDI parameters.

To configure the ShoreTel voice mail server for SMDI operations, follow the procedure below:

- Step 1** With ShoreWare Director still open, click on the **Application Servers** link.
- Step 2** Click on the name of the server (Headquarters or Remote) that will be acting as the voice mail server for the legacy PBX.
- Step 3** In the Simplified Message Desk Interface section of the Application Servers window, click on the drop-down menu and select **ShoreTel Voice Mail**. A new set of fields and menus related to SMDI appear.

Application Servers

Edit Server

Name:

Host IP Address:

Site:

SoftSwitch Name:

Voice Mail and Auto Attendant

Voice Mail Extension:

Voice Mail Login Extension:

Auto Attendant Extension:

Assigned User Group:

Default Auto-Attendant Menu:

Simplified Message Desk Interface

Mode:

Trunk Group:

COM Port (1 - 10):

Message Desk Number (1 - 999):

Number of Digits (2 - 32):

Translation Table:

Use for Call Data
 Use for MWI Data

Figure 14-8 Configuring ShoreTel voice mail server

- Step 4** In the **Trunk Group** drop-down menu, select the name of the SMDI trunk group that you created earlier. This tells the server the name of the trunk group from which it should expect to receive voice mail calls.
- Step 5** In the **COM Port** field, enter the numerical value (from 1-10) that corresponds to the serial port of the ShoreTel server where you will be connecting the serial port. (This serial port will be used to route out-of-band SMDI signaling information between the PBX link device and the ShoreTel server.)
- Step 6** The Message Desk Number, which has a range of 1-999, is optional and can be set to the default value of 1. Check with the vendor for this value.

NOTE The Message Desk Number is used to indicate a specific system in situations where a number of SMDI links have been daisy-chained together. This value allows each system to know which data belongs to it. In most cases this parameter is set to 1, since only one system will be using the SMDI link.

Step 7 The Number of Digits field, which has a range of 2-32, is optional.

NOTE This value determines how many digits the ShoreTel system will send in SMDI extension fields. This value needs to be set to the value the voice mail system expects. The most common values are either 7 or 10. If the system extension length is less than the number of SMDI digits, then the extension number will be padded. For example, if the ShoreTel system needs to send extension 456 and the number of SMDI digits is set to 7, extension 0000456 will be sent. If no padding is desired the number of digits should be set to 2. In the above example with the number of SMDI digits set to 2 only 456 will be sent.

Step 8 The translation table is optional and can be left as is for now. We will be returning to the related topic of digit translation tables later.

Step 9 Click the **Save** button to store your changes.

Creating a User Group

After setting up the ShoreTel voice mail server for SMDI, the next step is to add users to the system. You will create a user group, and in this user group you will specify that all members will use ShoreTel Voice Mail. Once this is done, then you will modify user profiles at the individual level. For now, we will talk about creating the user group.

To create a user group for users on the legacy PBX system, follow the procedure below:

- Step 1** With ShoreWare Director still open, click on the **Users** link to expand the list.
 - a** Click on the **User Groups** link.
 - b** Click on the **Add New** link to display the **User Groups** window.

User Groups
Edit User Group

New Copy Save Delete Reset

Edit this record Refresh this page * m

Name: External PBX Users

COS - Telephony: Fully Featured [Go to this Class of Service](#)

COS - Call Permissions: Internal Only [Go to this Class of Service](#)

COS - Voice Mail: Large Mail Box [Go to this Class of Service](#)

Simplified Message Desk Interface Mode: None

Account Code Collection:

- None
- External Voice Mail
- ShoreTel Voice Mail

Show Call Manager users a list of account codes when dialing.

Send Caller ID as Caller's Emergency Service Identification (CESID).

Send DID as Caller's Emergency Service Identification (CESID).

Outgoing Trunk Groups (Access Code):

- Analog Loop Start (9)
- Digital Loop Start (9)
- Digital Wink Start (9)
- New Trunk Group (9)
- OSE PRI (9)
- PRI (9)
- Remote PRI (9)

Figure 14-9 Creating a user group for legacy users

- Step 2 Enter a Name for the user group in the Name field.
- Step 3 In the Simplified Message Desk Interface Mode drop-down window, select ShoreTel Voice Mail from the list.
- Step 4 Click the Save button to store your changes.

Adding an Individual User

After creating the user group, you can create user profiles for the legacy PBX users. To do so, follow the procedure below:

- Step 1 With ShoreWare Director still open, click on the Users link to expand the list.
- Step 2 Click on the Individual Users link.
- Step 3 In the Add new user at site field, select the server where you configured the ShoreTel voice mail for the PBX link device.
- Step 4 Click the Go link to display the Edit User window, shown below.

Users
Edit User

New Copy Save Delete Reset

General Personal Options Distribution Lists Refresh this page

First Name: Daffe

Last Name: Dukke

Number: 1822

License Type: Mailbox-Only

Caller ID: (e.g. +1 (408) 331-3300)

DID: +1408331 3921 (DID Range: +14083313921 - 3940)

PSTN Failover: None

User Group: External PBX Users Go to this User Group

Site: Anonymous Telephones
Executives
External PBX Users
House Telephones
IP Telephones
Managers
Staff
Voice Mail Notification

Language: e

Home Port: Ports End Top Sg24 - 3
SoftSwitch SoftSwitch

Current Port: SoftSwitch Go Home

Jack #:

Figure 14-10 Creating a user record for a legacy user

- Step 5** Enter a name for the user in the First Name and Last Name fields.
- Step 6** In the License Type drop-down menu, click on the arrow-button and select **Mailbox-Only**. The user is located on the legacy system and thus, he or she does not require a ShoreTel extension.
- Step 7** In the User Group drop-down menu, click on the arrow-button and find and select the name of the user group you just created.
- Step 8** Click the Save button to store your changes.

Configuring the Serial Connection

The ShoreTel voice mail system will only support one serial link per application server. To support another legacy PBX, you will need another ShoreTel distributed application server. A serial cable (i.e. null modem) should be used to connect the legacy PBX to one of the COM ports of the ShoreTel server. Note that the ShoreTel system will extract the serial port settings, such as baud rate and parity bit values, from the Windows COM port settings. These settings can be verified by following the procedure below:

- 1 Right-click **My Computer**.
- 2 Select **Manage**.
- 3 Select **Device Manager**.
- 4 Left-click on **Ports (COM & LPT)**.
- 5 Right-click **Communications Port (COM1)**, and select **Properties**.
- 6 Left-click on the **Port Settings** tab.
- 7 Verify that the settings match those suggested by the documentation that came with your legacy PBX device.

PBX

Table 14-3 Supported PBXs

Manufacturer	Model
Nortel	<ul style="list-style-type: none"> • Meridian 1 • Nortel Norstar
Avaya	<ul style="list-style-type: none"> • System 75/85 • Definity
Mitel	<ul style="list-style-type: none"> • SX50 • SX200 • SX2000
Siemens	<ul style="list-style-type: none"> • 300S
NEC	<ul style="list-style-type: none"> • NEAX

PBX link

A PBXLink device may be needed to provide SMDI services for a legacy PBX that does not offer support for SMDI. The PBXLink devices, manufactured by CTL, provides integration services to allow certain digital PBXs to interface seamlessly with a Voice Messaging System. The PBXLink connects to the PBX using a digital telephone line and to the Voice Messaging System using an RS-232 link. The PBXLink uses information appearing on the emulated digital set to determine the original source and destination of the calls being forwarded to the voice mail system. This information is then communicated to the voice mail system on an RS-232 serial link using the industry standard “Centrex SMDI” protocol. The PBXLink is compatible with SMDI-compatible voice mail systems.

When using SMDI, ShoreTel voice mail configuration, the following features will not be supported:

- Office Anywhere
- Setting call handling mode
- Setting agent state

The following features will be supported:

- Recording greeting and name
- Setting TUI password
- Enable/disable envelope information
- Email voice message options
- Find Me
- Message functions including call back
- Message sending functions
- Workgroup
- ShoreTel voice mail
- Agents cannot be extensions in the legacy PBX
- System configuration
- Configuration parameters

System Requirements

The following are required on the ShoreTel 7.5 system, or on the legacy PBX to enable the integration of the two systems:

- ShoreTel 7.5 system
 - ShoreGear-T1 Voice Switch - The ShoreGear-T1 voice switch supports both T1 and PRI connections and includes an integrated CSU
- Legacy PBX
 - T1 or PRI card for the PBX
 - Available card slot and capacity for the added trunks
 - Required software or licenses to support the desired trunk interface

NOTE If PRI is used in the integration interface, the legacy PBX must emulate the CO or support Network Side PRI.

Connection Cable

Special Considerations - Nortel PBX

When integrating with a Nortel Meridian PBX, a T1 connection must be used since the legacy system does not support Network Side PRI.

Special Considerations - Avaya/Lucent PBX

Universal Dial Plan (UDP) Must be Active - This capability enables transparent dialing between the Avaya/Lucent PBX and the ShoreTel 7.5 system. If this is not active, users on the PBX will either have to dial a trunk access code to reach the users on the ShoreTel 7.5 system, or configure forwarding from an extension in the legacy system to the ShoreTel 7.5 extension using the trunk access code and the extension.

NOTE In some cases, this feature must be purchased separately from Avaya/Lucent.

Administration and Configuration

Tie Trunk Configuration

The following summary describes the administration and configuration of the digital trunk for connecting the ShoreTel 7.5 system to the legacy system.

Services Summary

Before starting, a summary of the required configuration should be made based on the required services in the interface.

Desired Service	Required Configuration
Extension-to-Extension Calling	<p>Enable inbound services on the trunk.</p> <p>Direct inbound calls using extension routing to the ShoreTel 7.5 extensions.</p> <p>Enable off-system extensions.</p> <p>Define the off-system extension range to match extensions on the remote PBX.</p>
Inbound Trunks on Remote PBX	<p>Enable inbound services on the trunk.</p> <p>Direct inbound calls using extension routing to the ShoreTel 7.5 extensions.</p> <p>Outbound trunks on the remote PBX enable outbound services on the trunk.</p> <p>Configure any required access code for the trunk and the local area code for the trunks connected to the remote PBX.</p> <p>Configure the desired trunk services such as local, long distance, and so on.</p> <p>Configure the dialing format and any required digit sequences that are to be pre-pended to the dialed numbers.</p> <p>Note Users must have access rights to the trunk group to use the trunk for outbound calls.</p>
Consolidated Long Distance	<p>Enable outbound services on the trunk.</p> <p>Configure any required access code for the trunk and the local area code for the trunks connected to the remote PBX.</p> <p>Configure the desired trunk services such as long distance, international, and so on.</p> <p>Configure the dialing format and any required digit sequences that are to be pre-pended to the dialed numbers.</p> <p>Note Users must have access rights to the trunk group to use the trunk for outbound calls.</p>

Trunk Configuration

The following steps describe how to configure the trunk for integrating the legacy PBX and the ShoreTel 7.5 system. Some steps are optional depending on the types of services desired as summarized above.

To create a new trunk group

- Step 1** In the ShoreWare Director, select Trunk Groups from the navigation frame to open the **Trunk Groups list** page.
- Step 2** Select the site where the trunk will be integrated and the type of trunk to configure - Digital Wink Start for T1 or PRI for PRI - and select Go. The new trunk group is created and the **Trunk Group Edit** page appears.
- Step 3** Click Save to store the trunk group configuration changes.

To configure inbound services with extension routing

- Step 1** In ShoreWare Director, open the Trunk Group edit page for the tie trunk.
- Step 2** Configure the number of digits received to match the number of digits sent by the remote PBX. This must match the extension length.
- Step 3** Enable **Extension Routing** by checking the box. This directs all the received calls to the configured ShoreTel 7.5 extension that matches the received DNIS digits.
- Step 4** Select a **Destination** to provide a back-up when the received digits do not match an extension in the ShoreTel 7.5 system.
- Step 5** Click Save to save the trunk group configuration.

To configure off-system extensions

- Step 1** In ShoreWare Director, open the Trunk Group edit page for the tie trunk.
- Step 2** Select the Edit button by the off-system Extensions. The Off Systems Extension Range dialog is displayed.
- Step 3** Click New and define the extension ranges for the extension off the remote PBX.
- Step 4** Click Save to save the trunk group configuration.

To configure outbound call routing (via the remote PBX)

- Step 1** In ShoreWare Director, open the Trunk Group edit Page for the tie trunk.
- Step 2** Enable outbound services by selecting the **Outbound** check box.
- Step 3** Configure the access code and areas codes for the trunk to match the PSTN connection of the remote PBX.

- Step 4** Select the desired trunk services to match the services provided via the remote PBX.
- Step 5** Select the desired Trunk Digit Manipulations to match the tie trunk and the required dialing for the PSTN connection to your legacy PBX.
- Step 6** As needed, configure the local prefixes and pre-pend digits to match the tie trunk and the required dialing for the PSTN connection to your legacy PBX.

For additional information on trunk configuration and information on configuration options, refer to the *ShoreTel 7.5 Administration Guide*.

*Part III: Installation and
 Configuration Process*

IP Phone Installation

With ShoreTel IP phones, you deploy your telephony system as an end-to-end IP network without dedicated station wiring. Connecting anywhere on the network, ShoreTel IP phones work with the ShoreTel Call Manager applications or can be used independently, providing an intuitive interface to essential telephone features.

ShoreTel IP phones are preconfigured by ShoreTel to work in conjunction with your ShoreTel 7.5 system and your network's Dynamic Host Configuration Protocol (DHCP) server. Once the servers are configured, you simply plug the phones into the network and they are automatically added to your ShoreTel 7.5 system.

NOTE If you are not using a DHCP server or it is not currently online, you can set a static IP address and other startup parameters directly at the IP phone. See Appendix D for more information.

Checklist

Review the following IP phone installation topics before proceeding to the next chapter:

Task Description	See
<input type="checkbox"/> Recommendations	page 15-2
<input type="checkbox"/> Preparing Your ShoreTel System for IP Phones	page 15-2
<input type="checkbox"/> Associating a User Group with Unassigned IP Phones	page 15-6

Recommendations

The following recommendations will help you install your IP phones.

- Make sure you have reviewed your network bandwidth and Quality of Service (QoS) strategies and configured your network for your IP phones as described in Chapter 9, “Network Requirements and Preparation.”
- Make sure you have configured DHCP vendor option 155 (ShorePhone-IP100) or option 156 (ShorePhone-IP110/212k/210/230/530/560/560g) with boot server information.

The phones may not boot properly if incorrect configuration data is present in the telephone. This can occur if the telephones were previously used in an environment where DHCP and automatic provisioning was not used, or the telephone is from a vendor other than ShoreTel. See Appendix D for information about changing the telephone to the correct settings.

Preparing Your ShoreTel System for IP Phones

This section provides the information you need to prepare your ShoreTel 7.5 system for IP phones.

Configuring Voice Switches for IP Phone Support

ShoreTel IP phones are supported by the ShoreGear-120/24, ShoreGear 90, ShoreGear-60/12, ShoreGear 50, ShoreGear-40/8 and ShoreGear 220T1/E1/T1A voice switches. To provide PSTN local dialing for IP phone users, every site where IP phones are in use must have a ShoreGear switch configured to support the number of IP phones at the site, plus local analog or T1 trunks.

The ShoreGear voice switches send a heartbeat to the IP phones every 60 seconds. If the heartbeat is not acknowledged within approximately four seconds, the switch considers the IP phone to be offline or unavailable. The voice switches continue to broadcast the heartbeat every minute. Any currently-offline IP phone that returns an acknowledgement is considered online and available.

To configure IP phone support on a ShoreGear voice switch, you must reserve ports for IP phone support on the ShoreGear Switch edit page in the ShoreWare Director. See the “Configuring Switches” chapter in the *ShoreTel 7.5 Administration Guide* for additional information.

Configuring Teleworker IP Phones

To configure an IP phone as a teleworker phone:

- Step 1** Define a range of IP addresses set aside for IP phone teleworkers as described in “Setting IP Address Ranges” on page 15-4.
- Step 2** Set a static IP address for the IP phone included in the range you defined in Step 1. For instructions on setting a static IP address for an IP phone, see Appendix D, “IP Phone Configuration.”
- Step 3** Connect the IP phone to your Ethernet connection to the Internet.

Assigning the Configuration Switches

You need to designate a switch for handling initial service requests from IP phones installed on your ShoreTel system. You have the option of assigning two switches to this function, to provide a backup in case of network problems. Every IP phone installation must have at least one configuration switch. If you do not assign a switch, the ShoreTel 7.5 system automatically assigns the first two ShoreGear-120/24, ShoreGear 90, ShoreGear-60/12, ShoreGear 50, or ShoreGear-40/8 ShoreGear 220T1/E1/T1A voice switches that you configure.

IP phones must be able to contact at least one of the assigned configuration switches when first connected to the network. If the IP phone cannot reach a configuration switch, the telephone will not be added to the system.

To assign configuration switches:

- Step 1** From the ShoreWare Director navigation pane, click **IP Phones**.
- Step 2** Click **IP Phones Options**. Figure 15-1 shows the **IP Phones Options** edit page. This page has several configurable parameters:
 - IP Phone Configuration Switch 1
 - IP Phone Configuration Switch 2
 - User Group for Unassigned IP Phones
 - IP Phone Announcement
 - IP Phone Password
 - Enable IP Phone Failover
 - Delay After Collecting Digits

IP Phone Options	
Edit	
Save Reset Help	
* modified	
Edit this record	Refresh this page
IP Phone Configuration Switch 1:	101 Fuji-24
IP Phone Configuration Switch 2:	103 Bottom SG24
User Group for Unassigned IP Phones:	IP Telephones
IP Phone Announcement:	ShoreTel 6
IP Phone Password (except IP-100): Confirm:
<input checked="" type="checkbox"/> Enable IP Phone Failover	
Delay After Collecting Digits (milliseconds):	1000

Figure 15-1 IP Phones Options Edit Page

- Step 3** Select an available switch from the pull-down lists for configuration switches 1 and 2.

For information on the other IP phone options, see the *ShoreTel 7.5 Administration Guide*.

Setting IP Address Ranges

If your system consists of more than one site, you must define an IP address range for IP phones at each site in the system. Setting ranges for each site ensures that new phones added to the system will be associated with the correct voice switch at the telephone's site.

You can view the IP address range for each site from the **IP Address Map** list page, shown in Figure 15-2. The page lists the sites and associated IP address ranges.

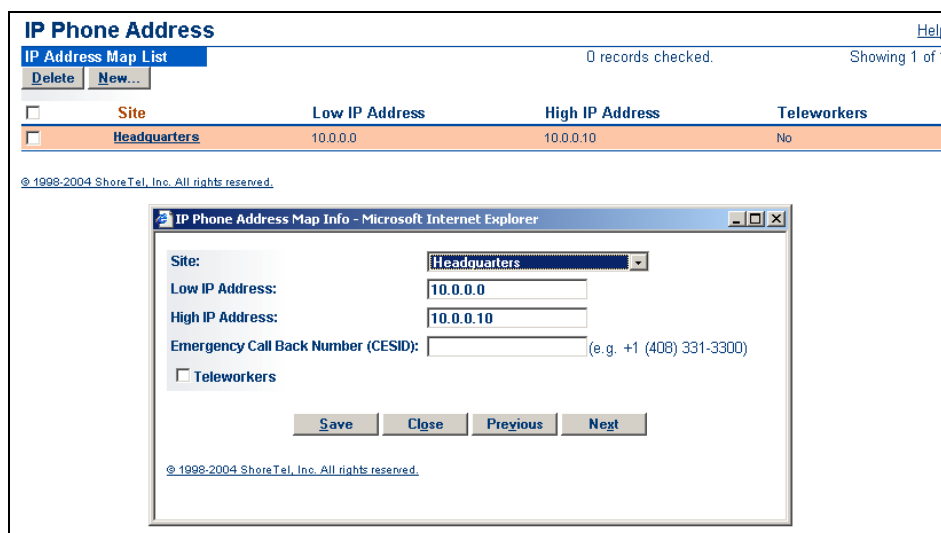

Figure 15-2 IP Address Map List and IP Address Range Edit Pages

To add a site with IP phones, click **New** and enter the information on the **Site IP Address Range** edit page (see Figure 15-2). To delete a site from the list, click the check box to the left of the site and click the **Delete** button.

To edit the IP address range for a site:

- Step 1** On the IP Address Map List page, in the **Site** column, click the site for which you are setting a range. The **Site IP Address Range** edit page appears as shown in Figure 15-2.
- Step 2** If you are setting the IP address range for a site other than shown in the **Site** field, select it from the list.
- Step 3** Enter the lowest IP address in the **Low IP Address** field.
- Step 4** Enter the highest IP address in the **High IP Address** field.
- Step 5** If you are setting a range for teleworker IP phones, click the **Teleworkers** check box.

Step 6 To set the new range, click **Save**. You can set ranges for other sites in the system by clicking **Previous** or **Next**.

NOTE If a phone is added with an address that is not within a specified range for any site, or there are no IP address ranges defined for any site, the telephone will be automatically assigned to the headquarters site. This causes seven-digit numbers dialed from the IP phone to be dialed as numbers within the area code of the headquarters site. In addition, this causes all telephone calls to users who are not at the headquarters to use the configured inter-site voice encoding for that system.

DHCP Settings

ShoreTel IP phones are preconfigured to use the network's DHCP server for addressing and time zone information. In addition to its address and standard network addresses, the DHCP server's response also provides the following:

- **ShoreTel server address:** The ShoreTel server's address is used to access and download the latest telephone application software and the configuration information for the ShoreTel 7.5 system.
- **SNTP server and time zone offset:** The SNTP provides a standard network time to maintain the telephone's displayed time and date. The time zone offset indicates the correct offset from GMT time to ensure that the time display matches the user's time zone.

ShoreTel Server Address

The ShoreTel server provides the IP phones with the latest application software and the configuration information that enables the IP phone to be automatically added to the ShoreTel 7.5 system. The ShoreTel server's address must be provided to the phone as a vendor-specific option. ShorePhone-IP100 phones are preconfigured to look for the ShoreTel server's address to be specified as Vendor Specific DHCP Option 155. ShorePhone-IP110/210/212k/230/530/560/560g phones are preconfigured to look for the ShoreTel server's address to be specified as Vendor Specific DHCP Option 156. If these options are not available, the ShoreTel IP phones will use Option 66.

For help on configuring these DHCP Options, see "Configuring DHCP for ShoreTel IP Phones" on page 9-20.

SNTP Server

The DHCP server should be configured to provide the address of your network's SNTP server to provide date and time information to the IP phones.

GMT Offset

The DHCP server must provide the telephones with the appropriate Greenwich Mean Time (GMT) offset to adjust the provided network time for the time zone of the telephone's location. When a single DHCP server is used for IP phones in multiple sites, the DHCP server must be configured to provide the correct GMT offset for the different sites based on the location or subnet where the telephone that issues the DHCP request is located.

NOTE When using the Microsoft DHCP server, you must enter the time offset that is provided to the IP phones in hex (hexadecimal) if the offset is negative. If you enter a negative number in decimal, the DHCP server software modifies the entry to be the positive number of the same magnitude or the absolute value before storing the value in hex. For example, if the desired offset is -8 hours or -28800 seconds, you enter the hex value of 0xFFFF8F80.

-8 hr = 0xFFFF8F80

-7 hr = 0xFFFF9D90

-6 hr = 0xFFFFA8A0

-5 hr = 0xFFFFB9B0

Associating a User Group with Unassigned IP Phones

Unassigned IP phones are available for users configured for Any IP Phone. Select the user group that will have access to unassigned IP phones from the pull-down list.

Since unassigned IP phones are not associated with a user, you cannot report on calls made from these telephones and associate them with an individual user. It is recommended that unassigned IP phones be configured with a class of service with minimal calling privileges.

C H A P T E R 1 6

Installing ShoreGear Voice Switches

This chapter provides planning and installation information for the ShoreGear voice switches. Information on switch connectors and LEDs can be found in Chapter 13, “Site Requirements and Preparation.”

Checklist

Review the following topics before proceeding to the next chapter:

Task Description	See
<input type="checkbox"/> Planning	page 16-1
<input type="checkbox"/> Mounting the ShoreGear Voice Switches	page 16-2
<input type="checkbox"/> Installing SG-40/8, SG-50, SG-60/12, SG-90, SG-120/24 Voice Switches	page 16-3
<input type="checkbox"/> Installing SG-T1/E1, SG-220T1/T1A/E1 Voice Switches	page 16-4
<input type="checkbox"/> ShoreWare Director Switch Configuration	page 16-5

Planning

The requirements to install a ShoreGear voice switch are basically the same as any multisite installation. Please refer to the previous chapters in this guide for more information.

In summary, you must ensure that:

- The IP network between the main and remote site meets the bandwidth, latency, jitter, and packet loss requirements for a multisite installation.
- The IP network between the main and remote site has quality of service in place such that voice travels ahead of data.
- You have appropriate firewall considerations in place, including VPN if applicable.

Mounting the ShoreGear Voice Switches

To stack the ShoreGear voice switch in a rack:

- Step 1** Remove the voice switch from its shipping container.
- Step 2** Place the switch on a flat platform, such as a shelf.
- Step 3** Up to three switches can be stacked on top of each other.

To mount a full-width (SG-40/8, SG-60/12, SG-120/24) ShoreGear voice switch in a rack with brackets:

- Step 1** Remove the voice switch from its shipping container.
- Step 2** Attach the two mounting brackets, included with the ShoreGear voice switch, using the provided screws.
- Step 3** Use standard screws to mount the switch in the rack.

To mount a half-width (SG-50, SG-90, SG-220T1/E1/T1A) ShoreGear voice switch in a rack with brackets:

- Step 1** Remove the voice switch from its shipping container.
- Step 2** Mount a ShoreGear Dual Tray into the rack with the screws provided.
- Step 3** Install the half-width switch into the tray on either the left or right side of the tray. Two half-width switches can be placed in the same tray.
- Step 4** Use standard screws to mount the switch in the tray.

Refer to the *Quick Install Guide for the ShoreGear Dual Tray* (included with half-width switches) for details.

Installing SG-40/8, SG-50, SG-60/12, SG-90, SG-120/24 Voice Switches

The DHCP/BOOTP server must be configured prior to turning on the ShoreGear voice switch. Refer to Chapter 10, “Server Requirements” for more information.

To install the SG-40/8, SG-50, SG-60/12, SG-90, or SG-120/24 voice switch:

Step 1 Connect the switch to the appropriate LAN segment (such as a LAN switch) with the Category 5 RJ-45 interface cable.

NOTE For guaranteed voice quality, all ShoreGear voice switches can be connected to an isolated LAN segment.

Step 2 Plug an AC surge protector into a grounded AC power source (not provided).

NOTE Electrical surges, typically lightning transients, are very destructive to equipment connected to AC power sources.

Step 3 Plug the power cord into the power receptacle on the switch's back panel, and into an available socket on the AC surge protector. Most ShoreGear switch models do not have a power switch and power on as soon as you connect the switch to power.

NOTE The power LED flashes momentarily, and remains lit. If the LED is not lit, ensure that the power cord is plugged into the switch and the power source. If the LED continues flashing, there is an internal error. Unplug the switch to power it off, then power it back on. Refer to “Configuring Switches” in the *ShoreTel 7.5 Administration Guide* for a description of the flash patterns and their meaning, or contact ShoreTel Customer Operations at: <http://www.ShoreTel.com>

Once network communications are established, the network LEDs will indicate that the switch is connected to a 10 Mbps or 100 Mbps Ethernet environment, and that the switch is receiving and transmitting data.

Step 4 If applicable, connect the music-on-hold source to the audio input port.

Step 5 If applicable, connect your site's paging system to the audio output port.

Step 6 Refer to the *ShoreTel 7.5 Administration Guide* to configure the ShoreGear voice switch according to your site's requirements.

Step 7 Connect your trunk and telephone lines using the RJ-21X connector. For the RJ-21X pinouts, see “Connector Pinouts” on page 13-21.

Installing SG-T1/E1, SG-220T1/T1A/E1 Voice Switches

The DHCP/BOOTP server must be configured before turning on the voice switch.

To install the ShoreGear voice switch in a stack, follow these steps:

Step 1 Connect the switch to the appropriate LAN segment (such as a LAN switch or hub) with the Category 5 RJ-45 interface cable.

NOTE For guaranteed voice quality, all ShoreGear-T1s can be connected to a dedicated Ethernet switch port.

Step 2 Plug an AC surge protector into a grounded AC power source (not provided).

Step 3 Plug the power cord into the power receptacle on the switch's back panel, and into an available socket on the AC surge protector. Most ShoreGear switches do not have a power switch and will power on as soon as you connect the switch to power.

NOTE Electrical surges, typically lightning transients, are very destructive to equipment connected to AC power sources.

Step 4 Power on the voice switch.

The power LED flashes momentarily, and remains lit. If the LED is not lit, ensure that the power cord is plugged into the switch and the power source. If the LED continues flashing, there is an internal error. Unplug the switch to power it off, then power it back on. Refer to "Configuring Switches" in the *ShoreTel 7.5 Administration Guide* for a description of the flash patterns and their meaning, or contact ShoreTel Customer Operations at: <http://www.ShoreTel.com>

Once network communications are established, the network LEDs will indicate that the switch is connected to a 10 Mbps or 100 Mbps Ethernet environment, and that the switch is receiving and transmitting data.

Step 5 Refer to the *ShoreTel 7.5 Administration Guide* to configure the ShoreGear voice switch according to your site's requirements.

Step 6 Connect your T1/E1 line to the Telco port.

RJ-21X Cable Retainer Installation

A cable retainer for the RJ-21X port is included with some ShoreGear voice switches. The retainer consists of a metal bracket with a velcro strap.

To install the retainer:

- Step 1** Using a number 1 Phillips screwdriver, remove the two black Phillips head screws on either side of the RJ-21X port.
- Step 2** Place the retainer in the recessed area around the RJ-21X port.
- Step 3** Reinstall the two screws.
- Step 4** Plug in the RJ-21X cable.
- Step 5** Pull the velcro strap tightly around the connector on the RJ-21X cable, and fasten it.

ShoreWare Director Switch Configuration

To complete the installation, you need to configure the ShoreWare voice switches with ShoreWare Director. For more information, see the *ShoreTel 7.5 Administration Guide*.

Adding a ShoreGear-120/24, ShoreGear 90, ShoreGear-60/12, ShoreGear 50, or ShoreGear-40/8

To add a new ShoreGear voice switch to the ShoreTel 7.5 system, or to edit an existing switch configuration:

- Step 1** Log into ShoreWare Director and click **Switches** from the navigation frame.
- Step 2** To add a new switch, select the associated site and type of voice switch from the **Switches** list page and click **Go**.
- Step 3** If you are adding a new switch, enter its name in the **Name** field. If you are adding a new switch from a record that you copied, replace the existing name with a new one.
- Step 4** If you are adding a new switch, enter a descriptive name for the switch in the **Description** field. If you are adding a new switch from a record that you copied, replace the existing description with a new one, if applicable.
- Step 5** Click **Find Switches** and select an IP address from the **Find Switch** dialog box. This also adds the switch's MAC address in the **Ethernet Address** field.

NOTE The Find Switches feature only finds switches on the subnet of the server. You must manually type in the IP and Ethernet address for remote switches.

If the switch is not found, enter the switch's IP address in the **IP Address** field and then enter the switch's MAC address in the **Ethernet Address** field.

- Step 6** If the switch will be used to support IP phones, select the ports you want to dedicate to IP phone support.
- Step 7** If the switch will be used to support Make Me Conferencing, select the ports you want to dedicate to this feature.
- Step 8** If the switch will be used as a music-on-hold source, enable it by clicking the **Music Source** check box.
- Step 9** Click **Save** to save the configuration. The new switch is added to the table in the **Switches** page. If you modified an existing switch configuration, the table will be updated.

NOTE After you save your configuration, ports are allocated for the switch, and a graphical view of the switch ports appears. When you click a switch name from the table in the **Switches** page, this view appears automatically.

Adding a ShoreGear-T1 or ShoreGear-220T1/T1A

To add a switch to the ShoreTel system or edit an existing switch configuration:

- Step 1** To add a new switch, select the associated site and pick ShoreGear-T1/E1 or 220T1/E1/T1A from the list and click **Go**.
- Step 2** If you are adding a new switch, enter its name in the **Name** field. If you are adding a new switch from a record that you copied, replace the existing name with a new one.
- Step 3** If you are adding a new switch, enter a descriptive name for the switch in the **Description** field. If you are adding a new switch from a record that you copied, replace the existing description with a new one.
- Step 4** Click **Find Switches** and select an IP address from the **Find Switch** dialog box. This also adds the switch's MAC address in the **Ethernet Address** field.

NOTE The Find Switches feature only finds switches on the same subnet as the server. You must manually type in the IP and Ethernet address for remote switches.

If the switch is not found, enter the switch's IP address in the **IP Address** field, and enter the switch's MAC address in the **Ethernet Address** field.

- Step 5** In the **Built-in Capacity** fields, enter the total number of IP phone ports that will be allocated to this switch in the first field, and enter the number of SIP trunk ports that will be allocated to this switch in the second field.

Step 6 In the Protocol Type menu, select the type of service the switch will provide by clicking **CAS** (for T1 circuits only), or select one of the following other options: **ISDN Network**, **ISDN User**, **QSIG Master**, or **QSIG Slave**.

NOTE If you change the **Type** setting and click **Save**, the switch will prompt you to reboot when idle.

Step 7 Select the type of CO support that the ShoreGear switch will support by making a selection from the **Central Office Type** pull-down menu.

Step 8 Depending on the type of service provided by your telephone company, click either the **Slave** or the **Master Clock Source** drop-down menu.

Step 9 Depending on the type of service provided by your telephone company, click either the **ESF** or the **D4** framing format drop-down menu.

Step 10 Depending on the type of service provided by your telephone company, click either the **B8ZS** or the **AMI** line code drop-down menu.

Step 11 Determine the appropriate **Line Build Out** distance from the drop-down menu.

Step 12 Assign a trunk group, name/number, and patch-panel jack number to each channel, or click **Fill Down** to configure all channels with the same trunk group and name.

Step 13 Click **Save** to save the configuration. The new switch is added to the table in the **Switches** page. If you modified an existing switch configuration, the table will be updated.

Reference

Environmental Requirements

The ShoreGear voice switches (SG-120/24, SG-90, SG-60/12, SG-50, SG-40/8, SG-T1, SG-E1, SG-220T1/E1/T1A) require that the environmental specifications provided in Table 16-1 be met

Table 16-1 ShoreGear Voice Switch Environmental Specifications

Parameter	Specification
Operating temperature	0° C to 50° C
Operating humidity (non-condensing)	0% to 90%
Storage temperature	-30° C to 70° C
Storage humidity (non-condensing)	20% to 95%

Packaging Requirements

Table 16-2 lists the packaging requirements for the following ShoreGear voice switches:
 Full-width switches – (SG-120/24, SG-60/12, SG-40/8, SG-T1/E1)
 Half-width switches – (SG-90, SG-50, SG-220T1/E1/T1A)

Table 16-2 ShoreGear Voice Switch Packaging Specifications

Parameter	Specification
Vibration	
Power:	0.4 Grms, 1h per axis
Spectral Density:	5-500Hz @ 0.000323303 g2/Hz
Operation	
Power:	1.5G RMS
Spectral Density:	5-500Hz @ 0.00454645 g2/Hz
Packaged Transportation	
Material:	275 C Brown
Dimensions (full-width switches):	21+1/8 x 19 x 5+3/4
Dimensions (half-width switches):	19+1/8 x 12+1/2 x 6+1/2
Mechanical Shock:	80 Gs non-operating
Packaged Bounce:	8-corner standard drop test

Regulatory Compliance

Table 16-3 SG-E1 Voice Switch Physical Specifications

Parameter	ShoreGear-24
Safety	UL 60950, 3rd Edition, CAN/CSA 22.2 No. 60950, EN60950 (2000)
EMI	FCC Part 15, ICES-003, EN 55022, Class A/Class B
	Radio and Telecommunications Terminating Device Directive (R&TTE) 99/5/EC
	Low Voltage Directive 73 / 23 / EEC
	EMC Directive 89 / 336 / EEC With Amendment 93 / 68 / EEC
	GS Mark from TUV Rheinland (Notified Body)
	EN 55024 : 1998 +A1:2001 +A2:2003

Table 16-4 SG-120/24, SG-90, SG-60/12, SG-50, SG-40/8 Voice Switch Physical Specifications

Parameter	ShoreGear-24
Safety	UL 60950, 3rd Edition, CAN/CSA 22.2 No. 60950, EN60950 (2000)
Telephony Registration	FCC Part 68, Canada CS-03
EMI	FCC Part 15, ICES-003, EN 55022, Class A
	Radio and Telecommunications Terminating Device Directive (R&TTE) 99/5/EC
	Low Voltage Directive 73 / 23 / EEC
	EMC Directive 89 / 336 / EEC With Amendment 93 / 68 / EEC
	GS Mark from TUV Rheinland (Notified Body)
	EN 55024 : 1998 +A1:2001 +A2:2003

Physical Specifications

Table 16-5 SG-T1, SG-220T1/T1A Voice Switch Physical Specifications

Parameter	ShoreGear-24
Safety	UL 60950, 3rd Edition, CAN/CSA 22.2 No. 60950, EN60950 (2000)
Telephony Registration	FCC Part 68, Canada CS-03
EMI	FCC Part 15, ICES-003, EN 55022, Class A
	Radio and Telecommunications Terminating Device Directive (R&TTE) 99/5/EC
	Low Voltage Directive 73 / 23 / EEC
	EMC Directive 89 / 336 / EEC With Amendment 93 / 68 / EEC

General Specifications

Table 16-6 SG-120/24, SG-90, SG-60/12, SG-50, SG-40/8, SG-E1/T1, and SG-220T1/E1/T1A Voice Switch Specifications

Parameter	ShoreGear-24
Power Supply	100-240 VAC 50-60 Hz 2A max (full-width switches) 1A max (half-width switches)
Mounting Options	19 inch rack mount
Integrated OA&M	

C H A P T E R 1 7

Server Installation

This chapter describes the installation procedures for your main and distributed ShoreWare servers.

Checklist

Carefully review the following server installation topics before moving on to the next chapter:

Task Description	See
<input type="checkbox"/> Installing Microsoft Windows Server 2003 Components	page 17-2
<input type="checkbox"/> Installing Microsoft Windows Server 2003 Components	page 17-2
<input type="checkbox"/> Installing Software on the Main Server	page 17-3
<input type="checkbox"/> Installing Software on a Distributed Server	page 17-10
<input type="checkbox"/> Ensuring Proper Server Performance	page 17-16

Installing Microsoft Windows Server 2003 Components

This section describes how to install the Microsoft Windows Server 2003 components.

WARNING The File Transfer Protocol (FTP) Server is the one component not included by default in the Microsoft Windows Server 2003 installer. Make sure you select **File Transfer Protocol (FTP) Server** under the **Internet Information Service (IIS)** option during the installation.

Step 1 Install the Microsoft Windows Server 2003 (see ShoreTel Technical Note 0151 on the ShoreTel Customer Support website for more information).

- Select the **Internet Information Services (IIS)** option, including the following IIS sub-options:

File Transfer Protocol (FTP) Server
SMTP Service
World Wide Web Server

- Unselect **FrontPage Server Extensions**.

FrontPage Server Extensions are installed by default. This option should be disabled because these extensions have been a source of security problems for servers. There are several exploits using these extensions that allow a hacker to gain access to the file system.

NOTE If you are using RDP and also using Windows 2003, you must ensure the following:

- There are no Remote Desktop sessions with Options set for Remote Computer sound set to 'Bring to this Computer'.
- They must be configured to 'leave at remote computer'.

Installing Software on the Main Server

Before beginning software installation, you should close all programs and be sure no anti-virus software is running.

NOTE The ShoreWare server must be a **dedicated** server with **no** other applications installed. This means you should **not** be using this server for any of the following: Windows Domain controller, Terminal Server, Database Server (with MySQL), Web server, nor exchange server. This server must be exclusively dedicated to supporting ShoreWare.

Configuring DEP Settings Prior to Installing ShoreWare

We strongly recommended that prior to installing the ShoreWare software, you should configure the Data Execution Prevention (DEP) settings such that DEP is only enabled for essential Windows programs and services. To configure this setting, follow the procedure below:

- Step 1** Click **Start** and then select **Run**.
- Step 2** In the command prompt, type `sysdm.cpl`
- Step 3** In the “System Properties” window that appears, click the **Advanced** tab to display the following:

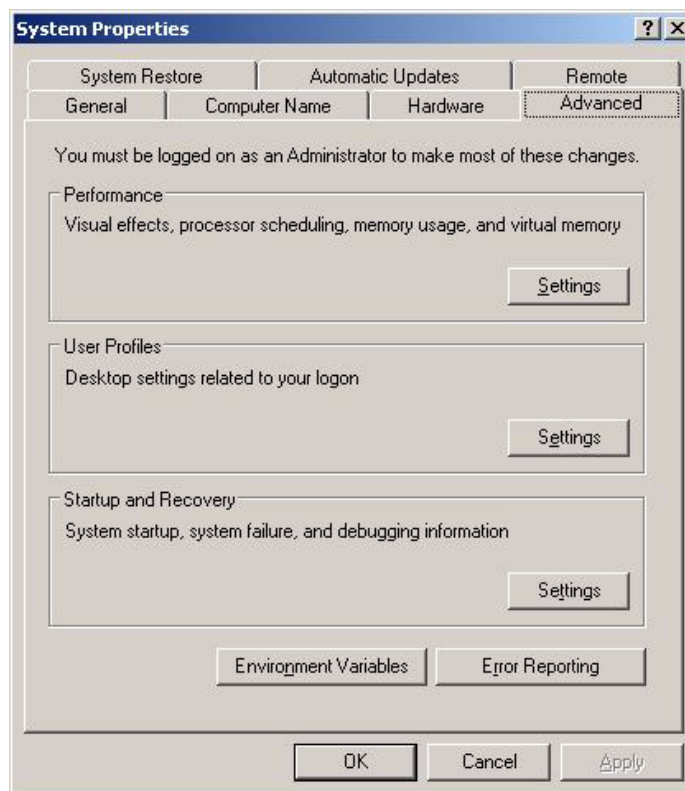

Figure 17-1 Click the Advanced tab

- Step 4** Under Performance, click the **Settings** button and in the new window that appears, click the **Data Execution Prevention** tab to display the following window:



Figure 17-2 Configuring DEP Performance Options

Step 5 There are two radio buttons. If it is not already selected, click the upper radio button - **Turn on DEP for essential Windows programs and services only** to select the Opt-In policy.

Step 6 Click OK two times to confirm your selection.

To install the main ShoreWare server:

- Step 1** Insert the ShoreWare DVD into the DVD drive and let ShoreWare Server Setup start automatically. If it does not start automatically, browse the DVD and double-click `setup.exe`.
- A DVD Browser window will be presented. Select the option ShoreWare Server on Windows 2003 (Figure 17-3).



Figure 17-3 DVD Browser

At this point, ShoreWare Server Setup checks for prerequisite software. If the required software is not installed, setup will automatically stop and you will have to install the proper prerequisite software before continuing; otherwise, you will see a dialog as the InstallShield Wizard is being prepared (Figure 17-4).

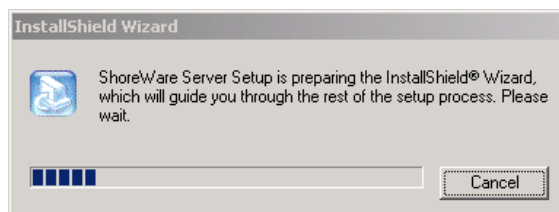

Figure 17-4 Preparing the InstallShield Wizard

Step 2 Review the welcome window (Figure 17-5). Click Next.

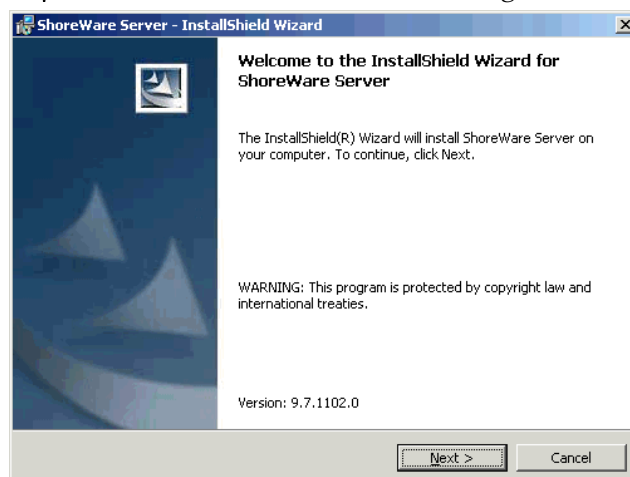

Figure 17-5 Welcome

Step 3 Review the license agreement (Figure 17-6). Click I accept... if you agree to the license terms and click Next.



Figure 17-6 License Agreement

Step 4 Choose the location of the server files and data files (Figure 17-7). The data files are unique to your system and include your system configuration, voice messages, and automated attendant prompts.

Step 5 These files will be stored in a ShoreTel data folder and should be included as part of your backup plan for the server.

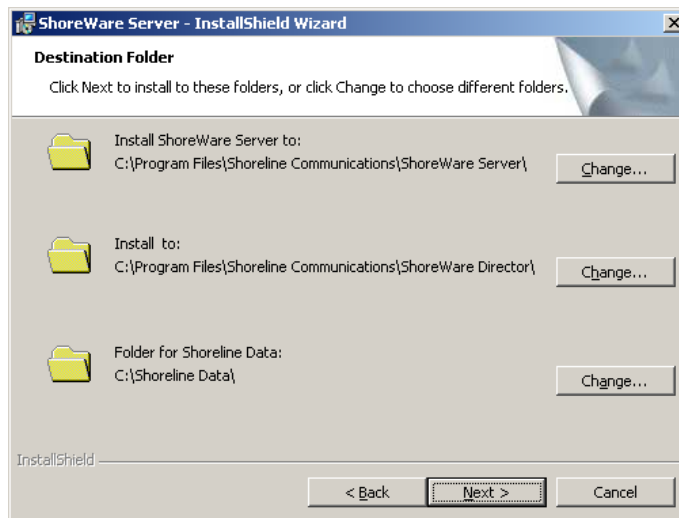

Figure 17-7 Choose Destination for ShoreWare Server and Data Files

Step 6 Select **Complete** installation and click **Next** (Figure 17-8).

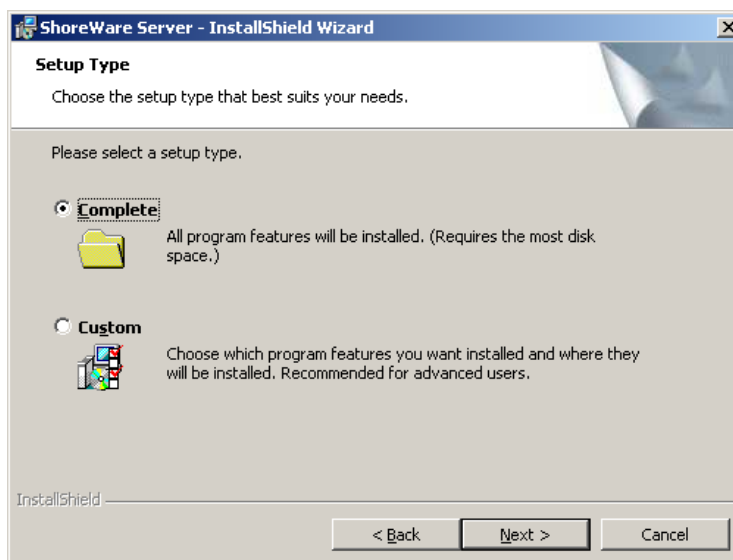

Figure 17-8 Setup Type

Step 7 At Ready to Install the Program, click **Install** (Figure 17-9).

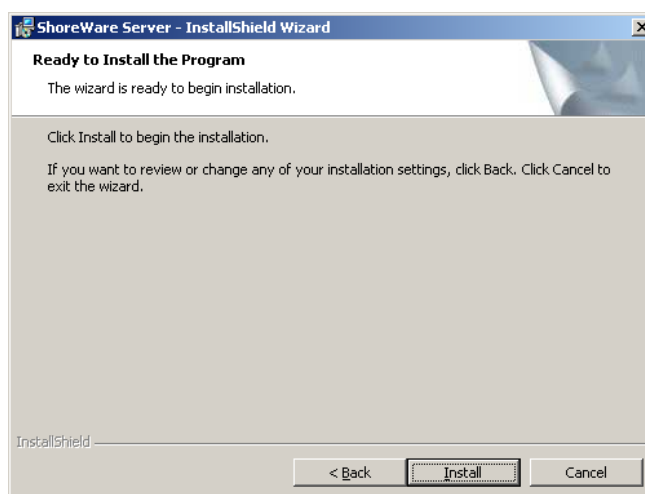

Figure 17-9 Ready to Install the Program

At this point, the InstallShield Wizard will present status on the setup process (Figure 17-10).

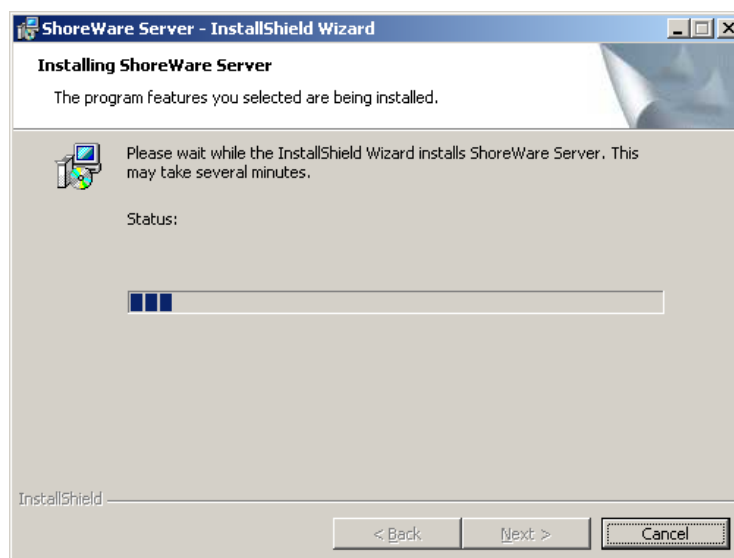

Figure 17-10 Setup Status

Step 8 When the InstallShield Wizard is done, you will be prompted to restart your server. Click **Finish** to restart.

Step 9 When the server restarts, you may be prompted to configure a location for the TAPI service provider. Simply enter the appropriate area code and access code and continue.

At this point, you have finished installing the ShoreWare server software. When the server restarts, all the necessary software will automatically start. It will typically take about 30 to 60 seconds after the operating system is up and running for the Microsoft Internet Information Services (IIS) and ShoreWare voice services to be running.

- Step 10** Launch ShoreWare Director by clicking the ShoreWare Director desktop icon. If IIS is not running yet, you will get an error window.
- Step 11** Log in to ShoreWare Director. If this is the first time you are logging into ShoreWare Director, use the default user ID and password of `admin` and `changeme`. You will also need to register your product.
- Step 12** Once you log in and register, you will be brought to Quick Look. You should confirm that all the ShoreWare services are running.

Upgrading Software on the Headquarters Server

If you are upgrading your ShoreWare Headquarters server, follow the same process used for installing new software. Setup will automatically determine that an upgrade is in process, and you will be presented with a subset of the installation wizard screens. (There is no need to change the destination folders of the ShoreWare files.)

Setup will look for the ShoreTel 7.5 database. If a database is found and it is an older version, Setup will make a backup copy and convert the database to the latest release. Note that Setup will not overwrite an existing database.

All voice applications (voice mail, automated attendant, workgroups, and so on) are affected until the upgrade is complete.

At the end of the installation you are warned that the installation will stop all ShoreWare services (see Figure 17-11).

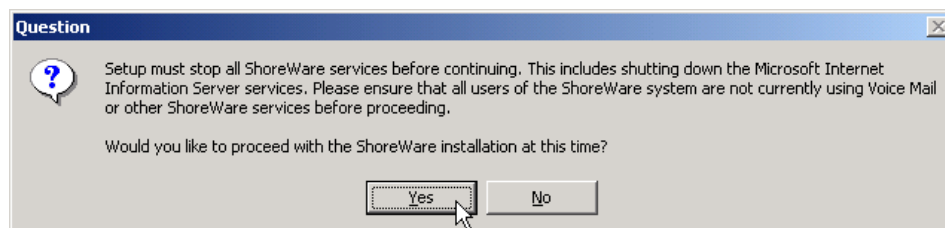

Figure 17-11 Warning

To finish the upgrade, restart your ShoreGear voice switches so that they will upgrade their firmware (this affects all calls in progress). Then upgrade your distributed servers.

Installing Software on a Distributed Server

A distributed ShoreWare server has the same software prerequisites as the main ShoreWare server. Before beginning software installation, you should close all programs and be sure no anti-virus software is running.

NOTE The Distributed ShoreWare server must be a **dedicated** server with **no** other applications installed. This means you should **not** be using this server for any of the following: Windows Domain controller, Terminal Server, Database Server (with MySQL), Web server, nor exchange server. This DSV server must be exclusively dedicated to supporting ShoreWare.

NOTE Prior to installing the software, please verify that the Data Execution Prevention setting have been set up correctly. See “Configuring DEP Settings Prior to Installing ShoreWare” on page 17-3 for details on this procedure.

To install the ShoreWare software on the distributed server:

Step 1 Navigate to the following web page (Figure 17-12) on the main ShoreWare server: `http://<server_name>/shorewaredirector/remotestall`. Click the link to install the software on the remote server.



Figure 17-12 Remote Server Install Web Page

NOTE An alternative to downloading the installation software from the website, you can perform a distributed server installation from the ShoreWare DVD.

Alternatively, insert the ShoreWare DVD into the DVD drive and let it auto-run. If it does not auto-run, browse the DVD and double-click

setup.exe. From the DVD browser window, select the **ShoreWare Distributed Server** option (shown in Figure 17-3 on page 17-5).

NOTE If you are not physically located at the distributed server, you can run a terminal session against the distributed server to avoid a trip to the remote site.

Step 2 If you are installing from the main server, you will be asked to open or save the file locally (Figure 17-13). Typically you will simply open the file across network.

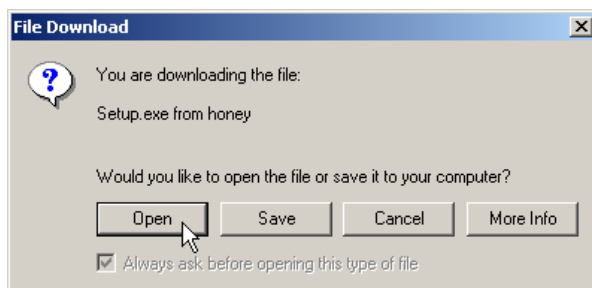

Figure 17-13 File Download

You will be presented with status (Figure 17-14); then Setup will prepare the InstallShield Wizard (Figure 17-15).

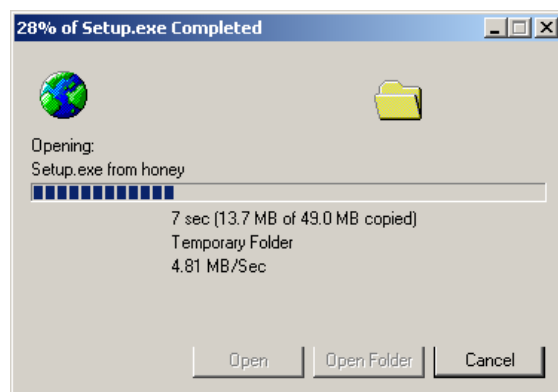

Figure 17-14 Status Dialog

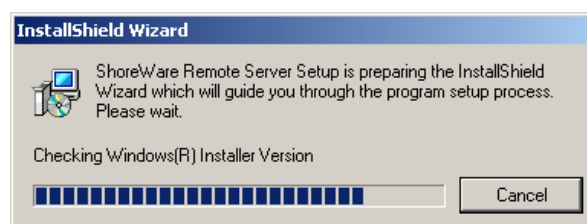

Figure 17-15 Preparing

Step 3 Review the welcome window that appears (Figure 17-16). Click Next.

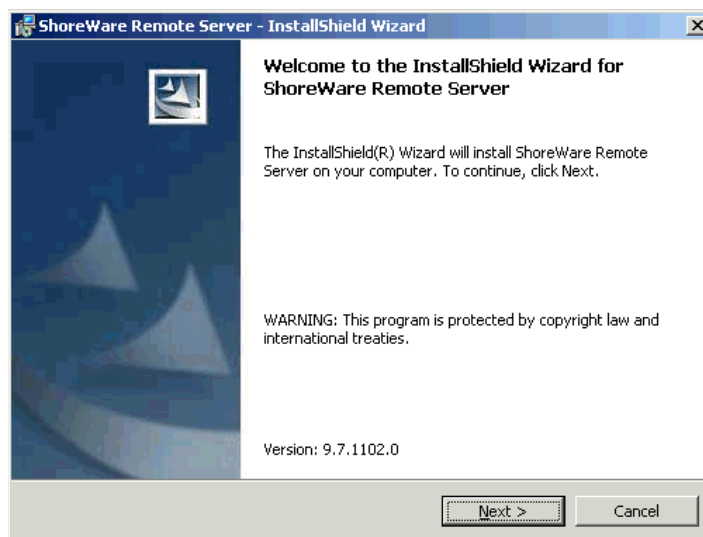

Figure 17-16 InstallShield Wizard Welcome

Step 4 Review the license agreement (Figure 17-17). Click **I accept...** if you agree to the license terms and click Next.

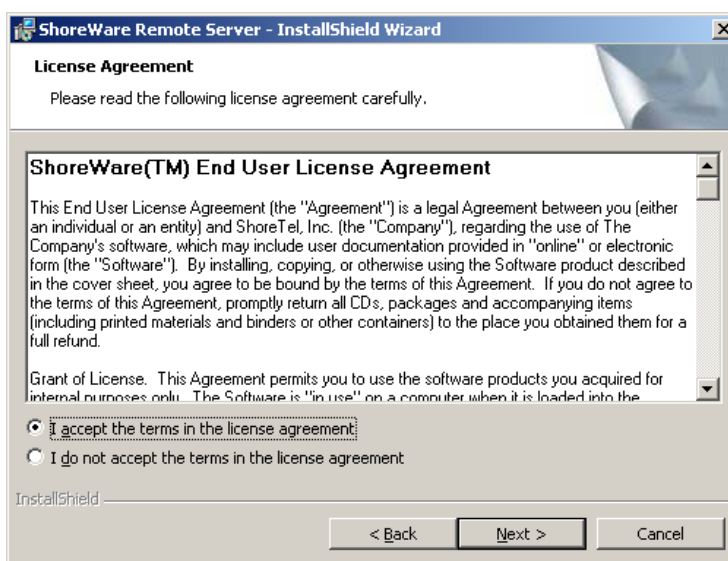

Figure 17-17 License Agreement

Step 5 Select the appropriate folder for the software files (Figure 17-18). Click **Next**.

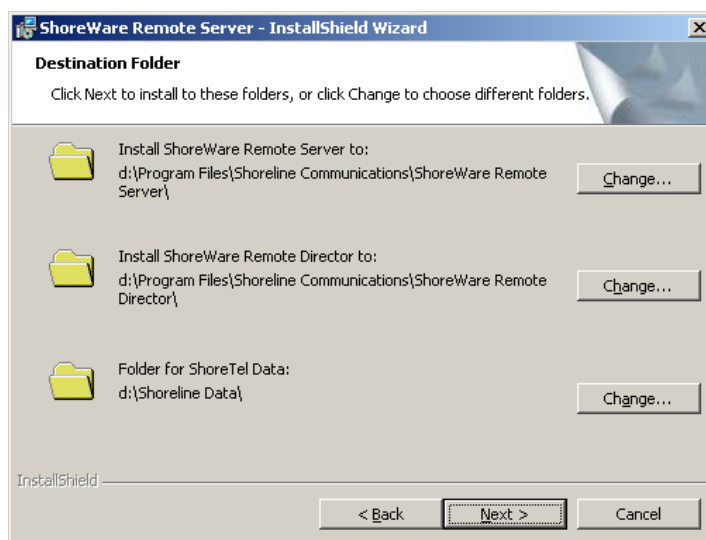

Figure 17-18 Select Destination Folders

Step 6 Enter the server name or IP address of the main ShoreWare server (Figure 17-19). ShoreTel recommends that you use the IP address such that your remote server and associated voice services are not dependent on address resolution. Click **Next**.

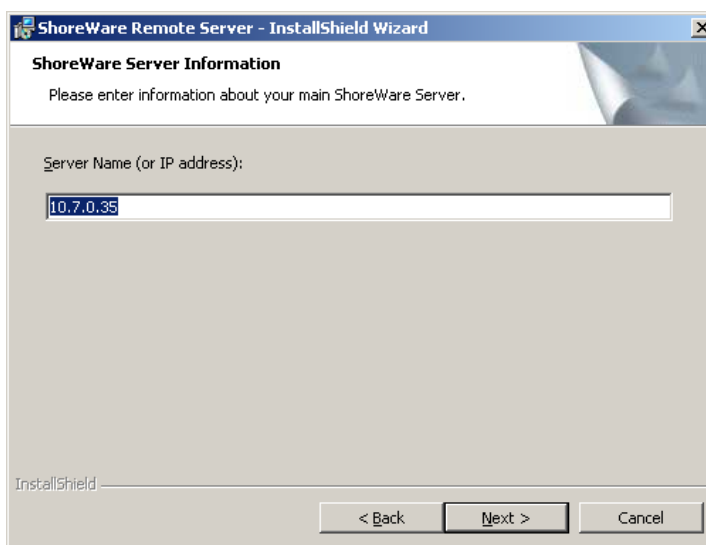

Figure 17-19 Enter Server Name or IP Address

Step 7 You are now ready to begin the installation (Figure 17-20). Click **Install**.

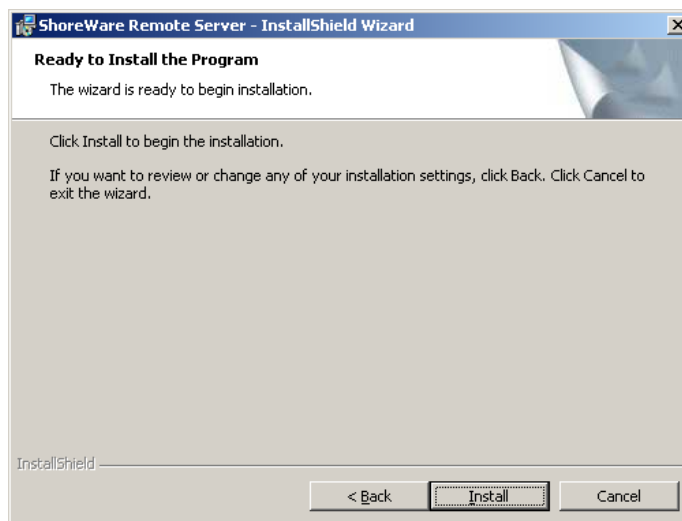

Figure 17-20 Ready to Install

The installation process begins (Figure 17-21).

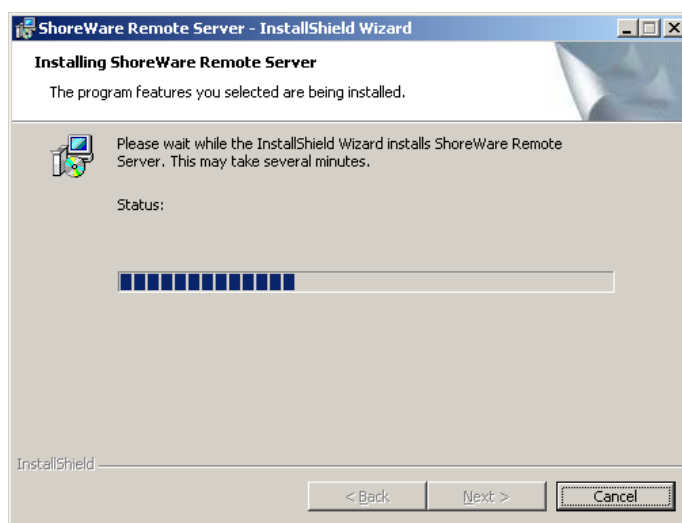

Figure 17-21 Please Wait

Step 8 When the wizard is done (Figure 17-22), click **Finish**.

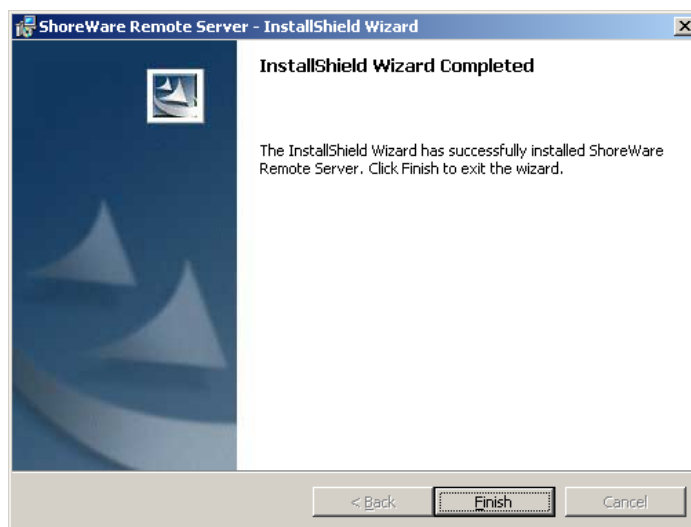

Figure 17-22 Completed

Step 9 The InstallShield Wizard will request that you restart the server (Figure 17-23). Click **Yes**.

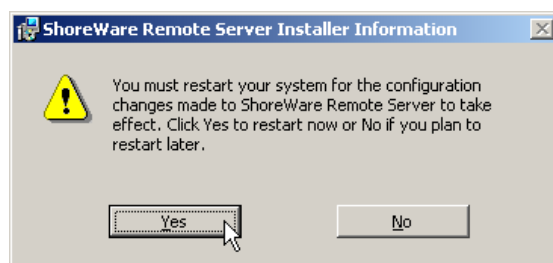

Figure 17-23 Restart

At this point, you have finished installing the distributed ShoreWare server software. When the server restarts, all the necessary software will automatically start. It will typically take about 30 to 60 seconds after the operating system is up and running for the Microsoft Internet Information Services (IIS) and ShoreWare voice services to be running.

Step 10 Log in to ShoreWare Director. You will be brought to QuickLook. You should confirm that all the ShoreWare services are running on the distributed server.

Notes About Upgrading Software on the Distributed Server

If you are upgrading your distributed ShoreWare server, follow the same process as for installing new software. Setup will automatically determine that an upgrade is in process, and you will be presented with a subset of the installation wizard screens. (There is no need to change the destination folders of the ShoreWare files.)

Ensuring Proper Server Performance

The following are some guidelines for ensuring the best performance from your ShoreWare server. This by no means is an exhaustive list. Please refer to a reference book on the subject or information on the web at www.microsoft.com.

- Make sure the server meets the hardware requirements, especially the memory requirements.
- Make sure the hard disk is not fragmented.
- Install the ShoreWare server onto an NTFS partition. Do not install the ShoreWare server software onto a FAT partition, especially the ShoreTel data folder. FAT partitions are restricted to 16-bit DOS addressing methods, which limit the size of the partition to 2 GB (insufficient for the ShoreTel application).
- Make sure you optimize server performance for background services rather than for applications. The voice services running on the server are real-time services that could be negatively affected by having an application running in the foreground.
 - To configure this option, go to Control Panel and open the System icon. In the System Properties window (Figure 17-24), click the **Advanced** tab and then click the **Performance Options** button. From the Performance Options window, select the option to optimize performance for **Background services**.

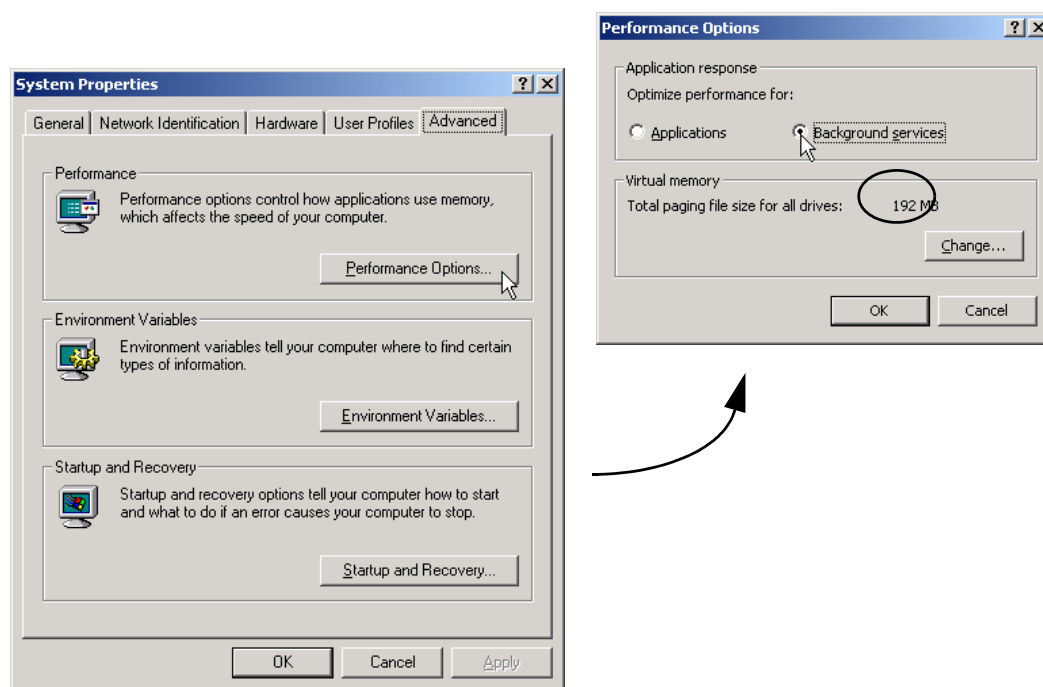

Figure 17-24 System Control Panel and Performance Options

- Make sure the paging file size (virtual memory) on the server is large enough.
 - To check the paging file size, go back to the Performance Options window shown in Figure 17-24. The paging file size should be 1 to 3 times larger than the physical memory on the server. If you have 512 MB of memory, the paging file size should be between 512 MB and 1536 MB. Increase the paging file size by clicking the **Change** button.

- Make sure you set the server to maximize for network performance.
 - To configure this option, go to Control Panel, open the **Network and Dial-up Connections** icon, and then open the **Local Area Connection** icon. From the Local Area Connection Properties window (Figure 17-25), select the **File and Printer Sharing for Microsoft Networks** item and click **Properties**.

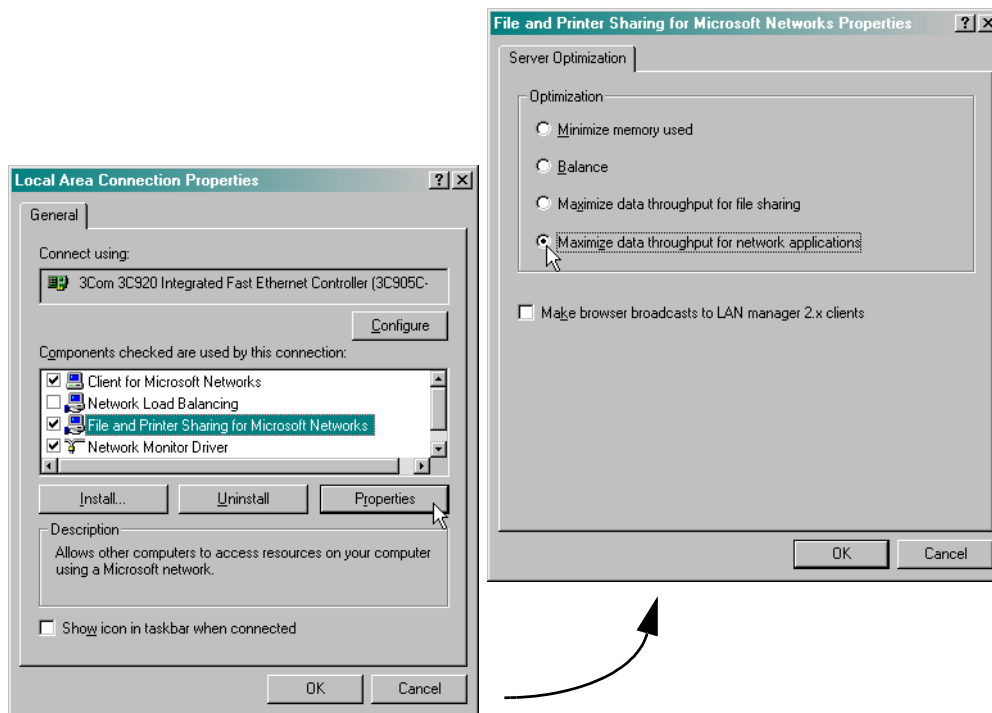

Figure 17-25 Network Server Dialog

C H A P T E R 1 8

Desktop Installation

This chapter covers the procedure for installing the ShoreWare Call Manager application on a desktop computer. You can install this application or have users perform the installation (in which case the server can notify them with information on their extensions and how to install the Call Manager).

Checklist

Review the following Call Manager installation topics before proceeding to the next chapter:

Task Description	See
<input type="checkbox"/> Recommendations	page 18-1
<input type="checkbox"/> Notifying Users via Email	page 18-2
<input type="checkbox"/> Installation Procedure	page 18-2
<input type="checkbox"/> Configuring SoftPhone	page 18-9
<input type="checkbox"/> Installing Outlook Integration	page 18-12
<input type="checkbox"/> Upgrade Procedures	page 18-15
<input type="checkbox"/> User Licensing	page 18-16
<input type="checkbox"/> Other Considerations	page 18-18

See Chapter 12, “Desktop Requirements,” for all hardware and software requirements for the ShoreWare Call Manager application.

Recommendations

The following recommendations will assist you in installing the ShoreWare Call Manager application on your desktop computer.

- Make sure you have your server name, user name, password, and extension number. These are required when you start the ShoreWare Call Manager application for the first time.
- Close all applications before starting the ShoreWare software installation.
- With the Silent Client Install feature, the process of upgrading the client software on remote machines no longer requires administrative rights by the person running the install/upgrade or the client machines. An administrator can easily upgrade the software on all client machines (using Active Directory Group Policies) regardless of the permissions associated with those machines or the users who log into those machines.
- Many of the changes are reliant on Microsoft Active Directory. Microsoft Outlook must be configured in “Corporate or Workgroup” mode for Outlook integration to function properly. “Internet Only” mode is not supported.

Notifying Users via Email

To simplify installation, the ShoreTel 7.5 system provides an integrated software distribution feature. Using ShoreWare Director, the system administrator can send an email message to each user configured with an email address.

You can send all users, some users, or just one user an email message using the Notify Users page (Figure 18-1).

Figure 18-1 Notify Users page

Installation Procedure

This section provides the most typical steps associated with installing the ShoreWare Call Manager application. There are two methods of installing the ShoreWare Call Manager software:

- Silent Client Upgrade
- Standard Integrated Software Distribution

Silent Client Upgrade

The Silent Client Upgrade process allows for the upgrading of the client software on remote machines such that administrative rights are no longer needed by the person running the install/upgrade or the client machines. An administrator can easily upgrade the software on all client machines regardless of the permissions associated with those machines or the users who log into those machines.

Many of the changes are reliant on Microsoft Active Directory. The Microsoft Active Directory software handles the following tasks:

- Create a Group Policy Object to use to distribute the software package
- Assign a package to a group of computers running Windows 2003, or XP Professional, or Vista
- Publish a package
- Remove a package

NOTE You will need to install the following files from the Client DVD with file permissions set to Share and File level Access by group <everyone>:

- Data1.cab
- Setup.exe
- ShoreWare Call Manger.msi

Enabling the new Remote Client Upgrade functionality requires performing a number of tasks using Microsoft Active Directory. For information on performing those tasks, refer to the following Microsoft Reference articles:

- How To Use Group Policy to Remotely Install Software in Windows 2003.
 - Article # 816102 (for Windows 2003)

ShoreTel recommends selecting the **Prevent Users from Initiating Client Upgrades** check box in the Edit System Parameters window. For details, please refer to the “Other Parameters” section of the *ShoreTel 7.5 Administration Guide*.

NOTE Deploying the Call Manager using Group Policy does not install the SoftPhone. To launch the SoftPhone, the user must have administrative rights on their machine, and SoftPhone users must have permissions to download and install ActiveX controls.

Standard Integrated Software Distribution Overview

The ShoreTel 7.5 system’s integrated software distribution feature simplifies installation. Although the process presents a number of screens, there is a default installation that requires no input; you simply click through the screens until you are prompted to restart your desktop.

Users receive an email message from the ShoreTel 7.5 system containing the information they need to install the ShoreWare Call Manager application. The installation program is accessed using the URL listed in the email notification. Notice that the email notification includes the server name and the user name: Users will need this information later when they start the ShoreWare Call Manager application for the first time.

NOTE The software can also be installed from the ShoreWare Call Manager CD.

Installing the ShoreWare Call Manager Software

You must first install the ShoreWare Call Manager software.

To perform the installation:

- Step 1** Go to your browser to initiate the ShoreWare client installation. Click the URL listed in your email notification, or paste (or otherwise enter) it into your web browser program (Figure 18-2).

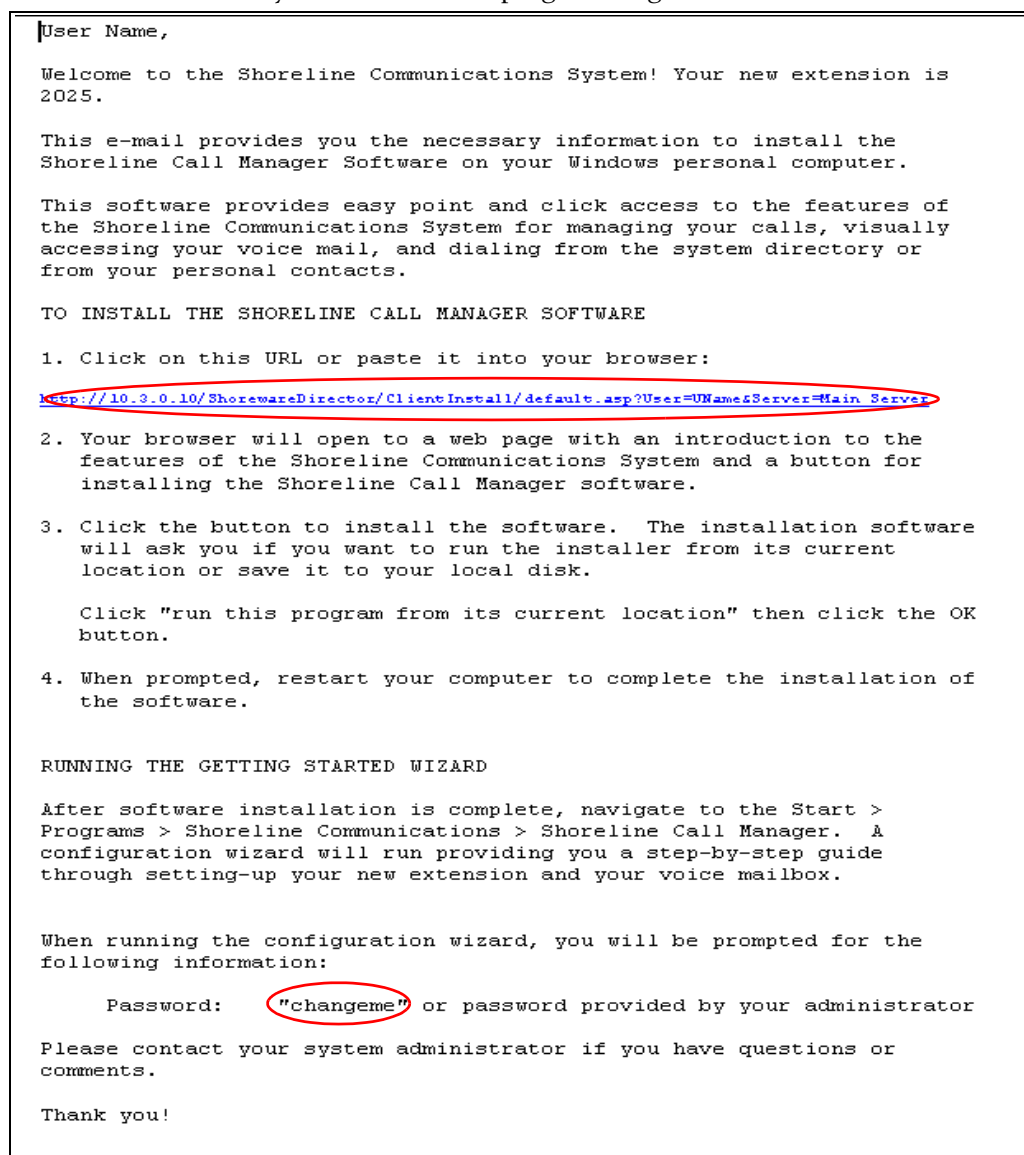

Figure 18-2 Notification Email

Alternatively, you can open a browser window and enter the URL `http://<ShoreTel_server_name>/shorewaredirector/clientinstall`.

Step 2 The ShoreWare **Client Install** page appears. After reviewing the information on this page, click the **Install** button (Figure 18-3).

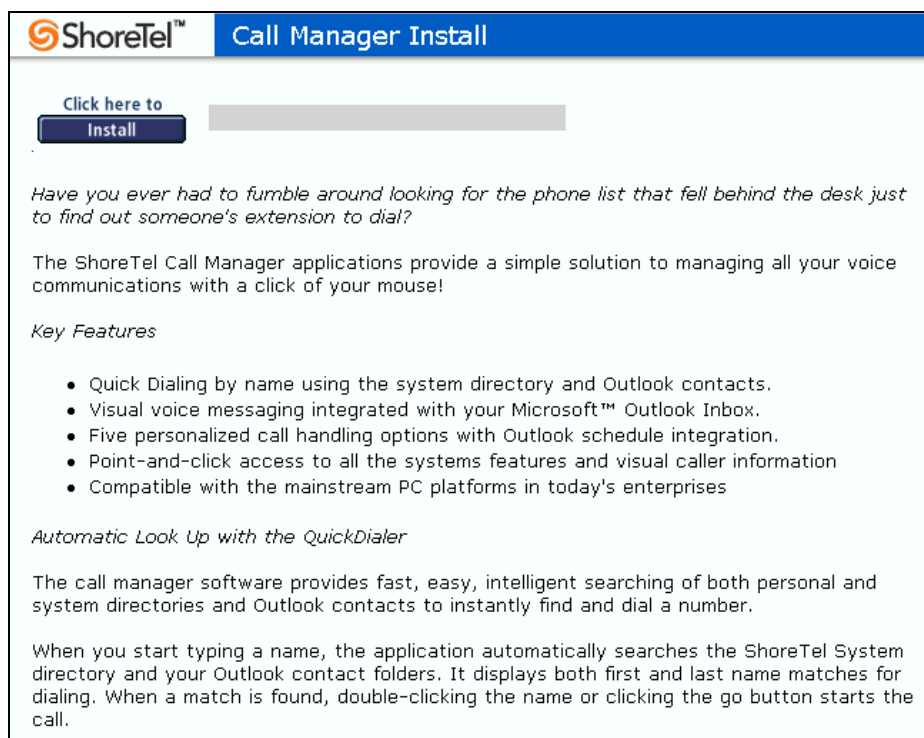

Figure 18-3 Client Install page

The InstallShield Wizard downloads the installation files (showing the progress of the download), “unpacks” the installation files, and configures the Windows Installer.

Step 3 The Welcome screen for the InstallShield Wizard appears (Figure 18-4). Notice that the version number of the ShoreWare software is shown at the bottom of the screen. To proceed, click **Next**.

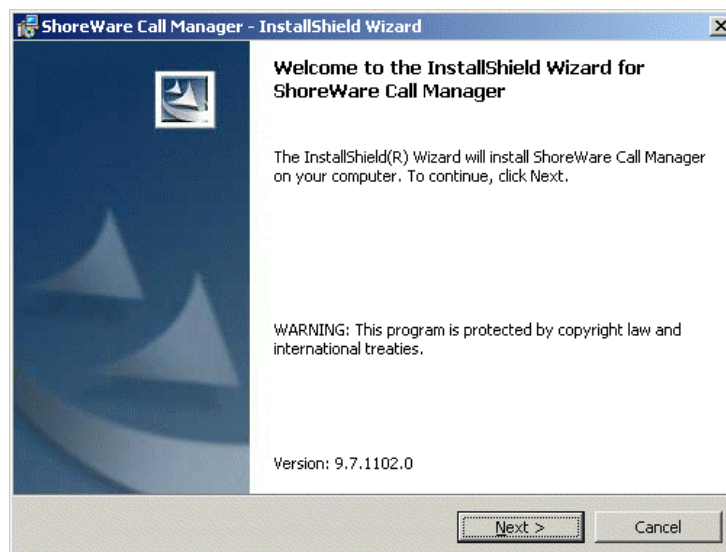

Figure 18-4 Welcome from InstallShield Wizard for ShoreWare Call Manager

Step 4 The ShoreWare End User License Agreement appears (Figure 18-5). If you agree to the license terms, select the option **I accept the terms in the license agreement** and click **Next**.

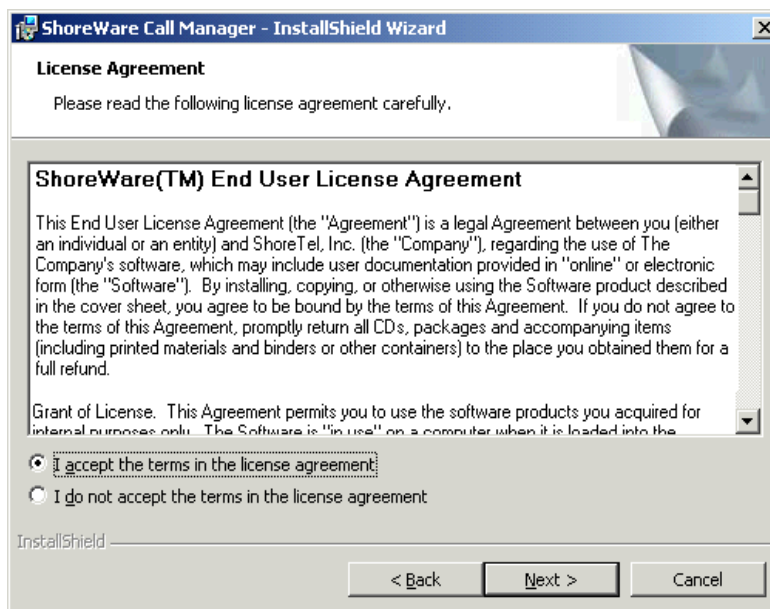

Figure 18-5 ShoreWare Software License Agreement

Step 5 The InstallShield Wizard presents you with a default destination folder (Figure 18-6) for the ShoreWare application. Click **Change** if you want to place the Call Manager application software in a different location. Click **Next** to continue.

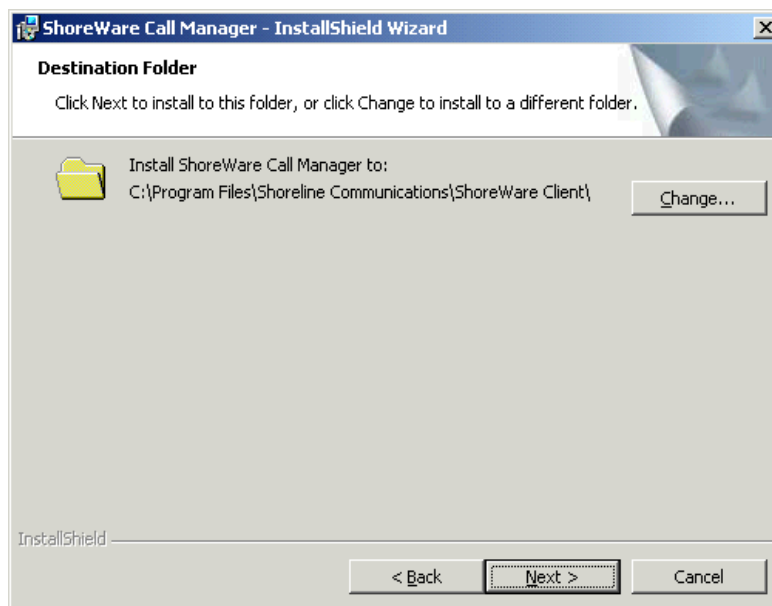

Figure 18-6 InstallShield Wizard Destination Folder

Step 6 The **Ready to Install** screen appears (Figure 18-7). InstallShield has gathered enough information about your system to proceed. Click **Install** to continue.

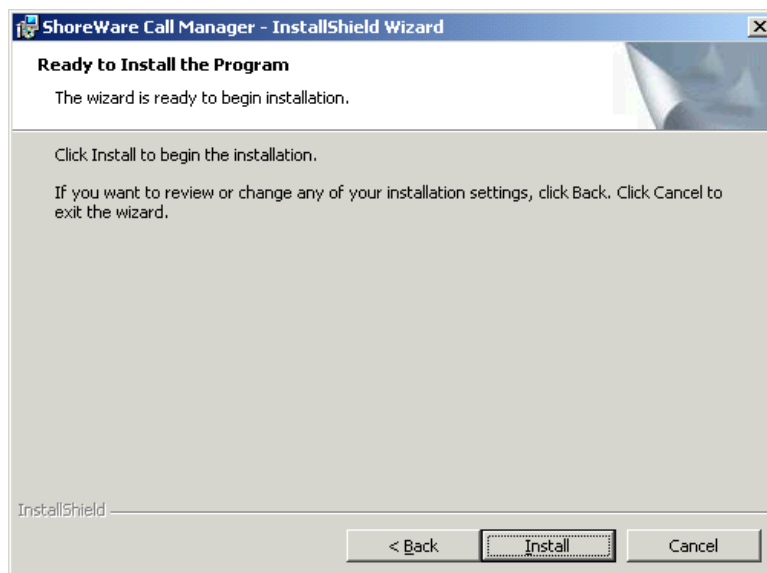

Figure 18-7 Ready to Install

Step 7 During the final installation process, a status screen appears as shown in Figure 18-8. Installation may take a few minutes. When it is complete, click **Next**.

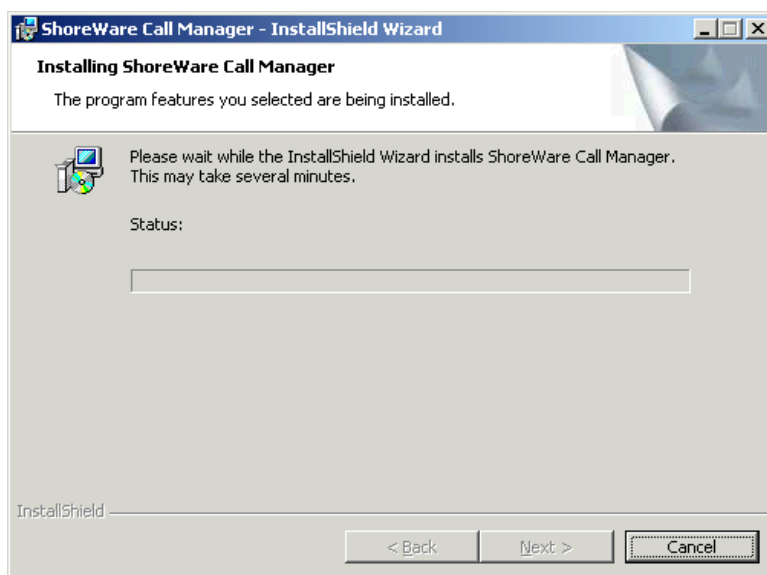

Figure 18-8 InstallShield Wizard Installation Status

Step 8 Software installation is complete when the **InstallShield Wizard Completed** screen appears (Figure 18-9). Click **Finish**.

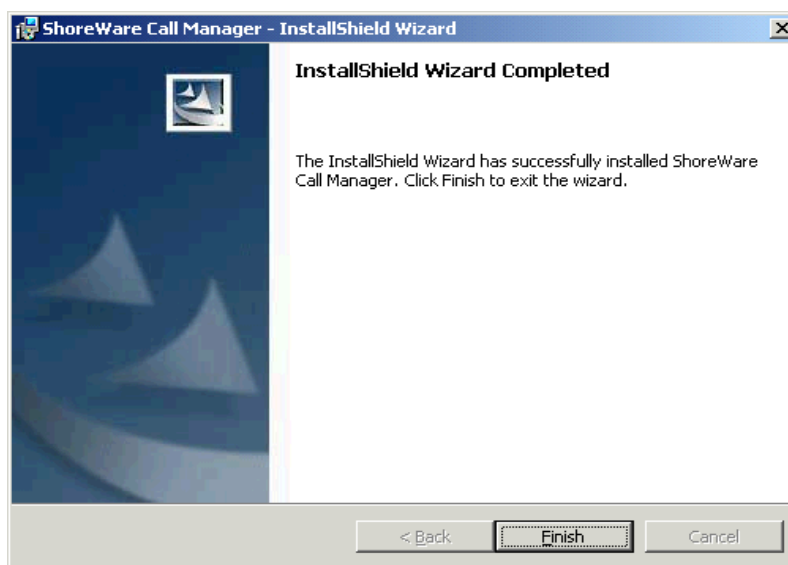

Figure 18-9 InstallShield Wizard Installation Completed

Step 9 When prompted to restart your computer (Figure 18-10), click **Yes**. The InstallShield Wizard shuts down your computer, and restarts it.

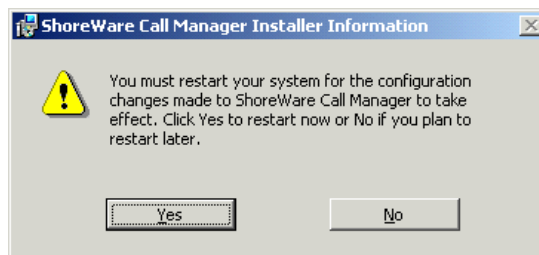

Figure 18-10 InstallShield Wizard Restart Prompt

When your desktop reappears, you will notice a new shortcut icon called **Shortcut to Call Manager**.

Configure the TAPI Dialing Parameters

The installation of the ShoreWare Call Manager application will require the user to provide his area code and dialing rules if not previously configured. When this is required, the Phone and Modem Options control panel applet will start during the installation to prompt for the necessary configuration information. To continue, specify the location and area code information. Additionally, configure the dialing rules section with the appropriate information for dialing external and long distance numbers. When the information is configured and the OK button is pressed, the installation will continue.

Starting the ShoreWare Call Manager Application

The ShoreWare Call Manager application can be started in one of three ways:

- Automatically upon system startup
- From the **Shortcut to Call Manager** icon on the desktop
- From the **Start > Programs > ShoreTel** menu item

The first time the ShoreWare Call Manager application is started, a wizard appears (Figure 18-11), prompting you to configure your Call Manager password, voice mail password, and recorded name.



Figure 18-11 Getting Started Wizard

If you have Microsoft Outlook installed on your computer, ShoreWare Call Manager will offer to install Outlook integrated voice mail. Click **Yes** to have your voice mail delivered to your Microsoft Outlook Inbox. You will also be prompted to configure AutoStart.

At this point you have completed the most typical steps associated with installing the ShoreWare Call Manager application. Additional procedures are described in the following sections.

Configuring SoftPhone

SoftPhone is available from ShoreWare Call Manager for licensed users. To provide a user with SoftPhone, you must obtain a keyed SoftPhone license and enable SoftPhone use from the **User edit** page of ShoreWare Director.

SoftPhone is not installed with the Call Manager client. To launch the SoftPhone, users must have administrative rights on their machine. SoftPhone users must also have permissions to download and install ActiveX controls. The simplest way to do this is to ensure that the main ShoreTel server has been added to the Internet Explorer Trusted Sites list.

Note that SoftPhone is not supported on a Citrix or Terminal services client. Although the feature may work when deployed, having the audio stream from the terminal server to the user's desktop is likely to result in high latency and poor audio quality.

Once you have activated the SoftPhone feature through ShoreWare Director, you should set the options.

To set the SoftPhone options:

Step 1 Launch SoftPhone from Call Manager.

Step 2 Click **Options**. The **MGCP** tab of the **SoftPhone Configuration** dialog box appears (below). The **End Point Name** is the read-only MGCP end point identifier. This is the identifier that appears on the IP phone list in ShoreWare Director.

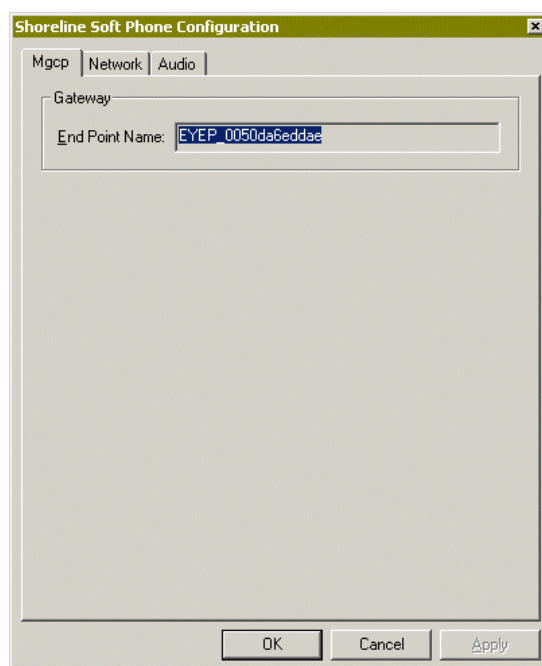

Figure 18-12 MGCP Tab of the SoftPhone Configuration Dialog Box

Step 3 Click the **Network** tab. The Network tab appears (below).

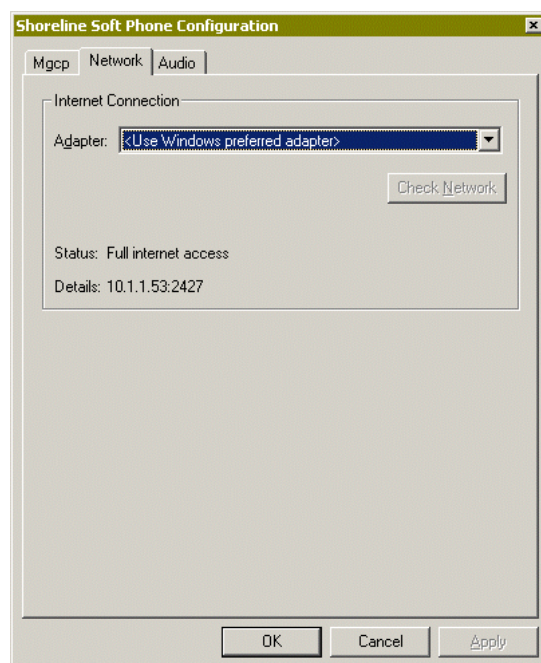

Figure 18-13 Network Tab of the SoftPhone Configuration Dialog Box

Step 4 Select the Internet adapter from the **Adapter** drop-down list. If the status line does not indicate **Full internet access**, click **Check Network** to find the MGCP service.

Step 5 Click the **Audio** tab. The Audio tab appears as shown in Figure 18-14.

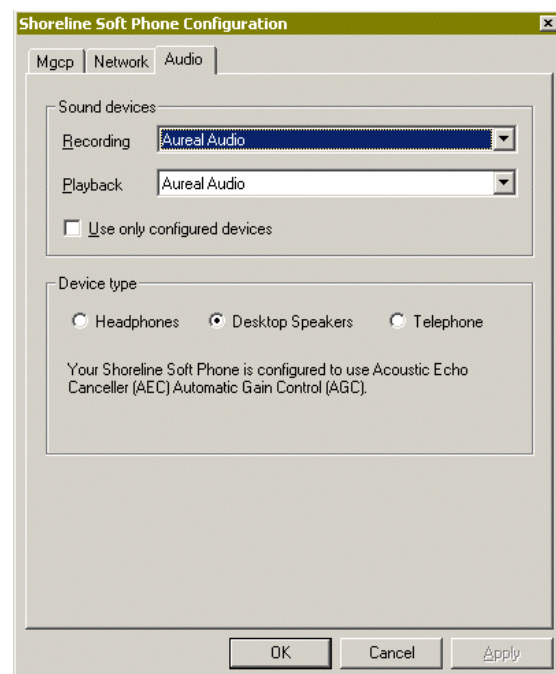

Figure 18-14 Audio Tab of the SoftPhone Configuration Dialog Box

- Step 6** Select the device used for recording from the **Recording** drop-down list.
- Step 7** Select the device used for playback from the **Playback** drop-down list.
- Step 8** Click **Use only configured devices** if you do not want SoftPhone to use any Windows preferred audio devices.
- Step 9** Select the device type.
- Step 10** Click OK.

Installing Outlook Integration

You can integrate Outlook to Call Manager in three areas: voice mail, call handling, and memorized phone number management. You can install these integrated components from the **Outlook** tab of the **ShoreTel System** dialog box.

Installing Voice Mail Integration

After you have installed voice mail integration, you have the option to:

- Use Outlook as the default voice mail client
- Attach voice mail to messages when moved
- Delete voice mail from messages when moved

Attach Voice Mail to Message when Moved

Check this option for your voice mail message to be saved in your Outlook folders for archival purposes. If you move a message to an Outlook folder when this option is in effect (and the **Delete Voice Mail from Message when Moved** option, described below, is not selected), a copy of the message is still stored on the voice mail server. If you delete the message in the voice mail interface, the Outlook copy is still available.

If you move a message without this option in effect and delete the message in the voice mail interface, the message information is still in Outlook, but the message itself is unavailable.

Delete Voice Mail from Message when Moved

Check this option to delete your voice mail messages from the ShoreTel System if you move a voice mail message to an Outlook folder. This is used to store messages in Outlook and free your voice mailbox for more messages.

To install voice mail integration:

- Step 1** In the Call Manager tool bar, click the **ShoreTel** icon. A shortcut menu appears.
- Step 2** Click **Configure ShoreTel System**. The **ShoreTel System** dialog box appears.

Step 3 Click the **Outlook** tab as shown in Figure 18-15.

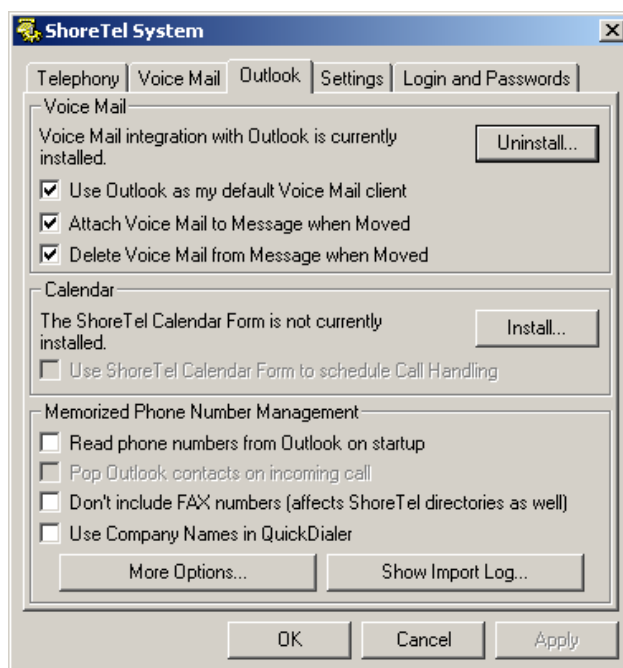

Figure 18-15 ShoreTel System Control Panel (Outlook Tab)

Step 4 Click **Install**. In some cases, a warning appears requesting that you close running applications before continuing. Close the applications as requested.

Installing Automatic Call Handling

Although the ShoreWare Call Manager installation installs the components for Microsoft Outlook integrated voice messaging, it does not install the components for the Microsoft Outlook Automated Call Handling feature. You install these components from the ShoreTel System control panel.

To install Automatic Call Handling:

Step 1 Right-click the **ShoreWare Call Manager** icon in the Windows taskbar tray.

The ShoreTel menu appears.

Step 2 Click **Configure ShoreTel System**.

The **ShoreTel System** dialog box appears.

Step 3 In the **ShoreTel System** dialog box, click the **Outlook** tab.

Step 4 In the **Call Handling** field, click **Install** to install the Microsoft components.

In some cases, a warning appears requesting that you close running applications before continuing. Close the applications as requested.¹

The installation takes a few minutes to complete. Once started, it cannot be interrupted.

NOTE Collaborative Data Objects or “CDO,” a component of Microsoft Outlook, must be installed to use the automatic call handling feature. Refer to documentation on Microsoft Outlook for information on adding this component to your installation.

Memorized Phone Number Management

You have the option of importing Outlook contacts to the Call Manager Quick Dial feature.

To set the option under Memorized Phone Number Management:

Step 1 In the **Memorized Phone Number Management** section, click **Read phone numbers from Outlook on startup** option.

Step 2 If you want to exclude FAX numbers from the search, click **Don't include FAX numbers**.

1. When the AutoCHM form is updated from one PCM release to another, it must be re-registered on a per-user basis. This registration cannot be done by the installer. It must be done when each user logs onto PCM for the first time following an upgrade. The registration requires that Outlook be closed. Users can expect to see a dialog box advising them to close Outlook if it is running at the time the registration is performed.

- Step 3** If you want Outlook Contact to appear when you have an incoming call, click **Pop Outlook contacts on incoming call**.
- Step 4** Click **More Options** to select which Outlook contacts to import. The MAPI Import Options dialog box appears.
- Step 5** Click **Enable Disk Caching** if you want Outlook contacts to be available without delay when Call Manager starts. When you have enabled disk caching, you can set when Call Manager imports contacts. If disk caching is not enabled, Call Manager imports contacts every time it starts.
- Step 6** Click the **Import Configurator** tab.
- Step 7** Click the locations where you want Call Manager to search for contact information.
- To select individual folders, click **Details** and check the folders you want searched for contact information.
- Step 8** Click **OK**.
- Step 9** If you want to import contacts now, return to the **Disk Cache Options** tab and click **Read Contacts Now**.

NOTE If you do not click this button, the Outlook contacts will be imported the next time you start Call Manager.

It will take some time for the ShoreWare Personal Call Manager to load your Microsoft Outlook Contacts. Your Outlook Contacts will not be available until loading has been completed.

Upgrade Procedures

When the ShoreTel 7.5 system is upgraded, users running any version of ShoreWare Call Manager greater than 5.5.600.0 will be informed that they must upgrade. Upgrades of the system may not require client upgrades. Refer to the ShoreLink online knowledge base on the ShoreCare web site to determine if a system upgrade requires client modifications.

User Licensing

ShoreTel 7.5 offers three user license types:

- Extension and mailbox
- Extension-only
- Mailbox-only

These new choices allow users to request a phone extension license without having to purchase a mailbox at the same time. This additional flexibility may be helpful in situations where a fax machine, a modem, or a lobby phone is desired and a mailbox for voice mail was not needed. Similarly, users can purchase a mailbox without having to purchase a phone extension.

NOTE Earlier releases of the ShoreTel product offered Single Site and Multi-Site Enterprise license keys. In this release, the Single Site key is no longer available. For existing users, the Single Site key can still be used and will be renamed as a “Single Site Extension and Mailbox” license. Previous Multi-Site Enterprise keys become “Extension and Mailbox” licenses.

Purchasing User Licenses

Each user must be configured with one of those three license types. A license must be purchased for each user, based upon the needs of that user. To see if an installation is in compliance with the number of licenses purchased, all Extension-Only, Mailbox-Only, and Mailbox-and-Extension users are counted and compared against the sum of the licenses purchased.

- Extension and mailbox: Purchase of this license entitles the user to be assigned to both a physical extension and a ShoreTel mailbox.
- Extension-only: Purchase of this license entitles the user to be assigned to a physical extension, either via explicit assignment or via Office Anywhere.
- Mailbox-only: Purchase of this license allows the user to be assigned to a ShoreTel voice mail-box.

Language Licenses

ShoreTel 7.5 supports Spanish, UK English, French, and German languages in addition to US English (which will remain the default language for new installations). One or more languages can be running at a site by purchasing a language license.

If only one language is needed at a single site, there is no need to purchase a language license. If Spanish or German is selected, the default language (English) must be disabled.

For instructions on configuring the User Licenses or Language Licenses via Director, please refer to the *ShoreTel 7.5 Administration Guide*.

License Control

License Control adds enforcement and branding to the ShoreTel product and provides tighter enforcement (via MAC address-based node locking) on existing licensing. When an existing ShoreTel system is upgraded to the current software release, an enforcement scheme requires entry of a system key.

When launching ShoreWare Director, you are asked to enter either a Small Business Edition (SBE) or Enterprise Edition (EE) key (see below for details on the differences between these two). You can request a key online via Director. If an invalid key is entered or if the field is left empty, you will be allowed to log into the system but an expiration time bomb will be activated, and you will be nagged to comply with the license requirements. If no action is taken within the 45-day grace period, ShoreWare Director will be locked and you will be unable to make any configuration changes to the system (although the phones will continue to work).

This 45-day period allows for unplanned, ad hoc changes that may cause you to exceed license limits while providing time to comply with the license requirements by either removing unneeded configurations or by ordering additional licenses.

You will be forced to purchase one of two keys available:

- SBE key – required for Small Business Edition
 - This key is for smaller sites that do not have remote offices
 - Use of this key will result in the display of SBE branding (on the initial login page above the navigation pane)
 - The number of users will be restricted to no more than 50
 - Users will be unable to add an additional site key
- EE key – required for Enterprise Edition
 - This is for larger sites with more than one site
 - Existing branding will be displayed
 - System behaves as it does today, except that number of sites is enforced via nagging
 - Block adding an additional SBE or EE key

Details:

- For an SBE system, the following features will be disabled:
 - AMIS
 - SMDI
 - On-net Dialing
 - PSTN failover

Please refer to the *ShoreTel 7.5 Administration Guide* for instructions on configuring SBE licensing via Director or for more information about the following types of Keyed License Types and Self-Audited License Types:

- Keyed License Types:
 - System License
 - Extension License
 - Mailbox License
 - SoftPhone License
 - Additional Language License
- Self-Audited License Types:

- Personal Call Manager Software License
- Advanced Call Manager Software License
- Operator Call Manager Software License
- Workgroup Agent Call Manager Software License
- Workgroup Supervisor Call Manager Software License
- Application Access License
- Remote Server Software License
- SIP Trunk License

Other Considerations

Windows Accounts and the ShoreWare Call Manager

You must log in to your computer with your Windows account information to gain access to the ShoreWare Call Manager application. If multiple users share the same computer, they must have separate Windows accounts to gain access to the ShoreWare Call Manager application.

Be sure to install ShoreWare Call Manager on the computer using the Admin account. When new users log in to Windows, they will see the Call Manager icon on the desktop. The first time this Call Manager is selected, the user is stepped through a “Getting Started” wizard.

Changing the Server Name

If the ShoreTel server name has changed, update the name of the server under Settings/ShoreTel login.

Part IV: Managing Cut-Over

C H A P T E R 1 9

Cut-Over

This chapter provides the requirements and other information for implementing the cut-over from your existing telephone system to the ShoreTel 7.5 system.

Checklist

You must complete the following tasks before proceeding to the next chapter:

Task Description	Owner	Status
<input type="checkbox"/> Confirm your telephony service orders with the telephone company.		
<input type="checkbox"/> Ensure that all end-user reference guides are distributed.		
<input type="checkbox"/> Make a copy of the site's floor plan.		
<input type="checkbox"/> Schedule your cut-over support.		
<input type="checkbox"/> Test all telephones and telephone lines.		
<input type="checkbox"/> Test the call flow, auto-attendant, and other services.		
<input type="checkbox"/> Confirm that cut-over coverage has been assigned and scheduled.		

Cut-Over Requirements

As cut-over approaches, you should review and confirm your plan, assemble the cut-over tools, and line up resources to support the cut-over.

Cut-Over Worksheet

The cut-over worksheet is used by the installer during the cut-over to move all end-users from the old system to the new. It is extremely important that the cut-over worksheet be prepared before the cut-over begins. You can use the cut-over worksheet at the end of this chapter to document all new and existing connections. A soft copy of this form is available in a planning and installation workbook from ShoreTel. Make copies as necessary.

NOTE Use a pencil when preparing the cut-over worksheets, to allow for changes that may occur during the cut-over.

New Trunks

New trunks should be installed before cut-over. This allows time for them to be terminated, configured, and tested with the ShoreTel 7.5 system.

Cut-Over Coverage

There are two aspects to cut-over coverage:

- The team involved with planning the ShoreTel 7.5 system must be on site before, during, and after cut-over.
- Appropriate coverage must be scheduled to monitor the newly installed ShoreTel 7.5 system for errors and last-minute configuration changes, and to help end-users with any questions they might have. ShoreTel recommends that you have support personnel on site before the first users arrive, to ensure that the system is functional and that telephone calls are processed properly.

Cut-Over Implementation

Once planning is completed, it is time to bring the ShoreTel 7.5 system into service. Use the checklists in this section to implement the cut-over, starting with the top-level checklist below.

Description	Completed
Complete the tasks listed on the basic cut-over checklist.	
Cut-over and test all trunks.	
Cut-over and test the remaining devices (telephone, fax machines, modems, and so on).	
Confirm the cut-over coverage.	

Basic Cut-Over Checklist

Description	Completed
Secure the telephone company's contact names, telephone numbers, and pager numbers for testing.	
Set up a command center to support cut-over activities.	
Ensure that copies of the floor plans and cut-over worksheets are available.	
Secure access to building and office areas that require ShoreGear voice switch telephones.	
Ensure that a telephone is installed next to the ShoreGear voice switch for testing.	
Ensure that music-on-hold is installed and tested.	
Record and test the auto-attendant greeting for on-hours and off-hours.	
Test all telephones.	
Test paging and night bell features, if applicable.	

Trunking Cut-Over

For existing trunking, use the cut-over worksheets to identify the trunks that are used from the old system (if applicable), and terminate them on the ShoreGear-120/24, ShoreGear-60/12, ShoreGear-40/8, ShoreGear-T1, and ShoreGear-E1 voice switches. Use a test telephone to dial in and out of each trunk, verify that it routes to the correct location, and listen closely to the voice quality.

When preparing new trunks for installation, use the following checklist.

Description	Completed
Identify the new trunks.	
Terminate the new trunks on the ShoreGear-120/24, ShoreGear-60/12, ShoreGear-40/8, ShoreGear-T1, and ShoreGear-E1 voice switches.	
Contact the telephone company's tester, and test each trunk (one at a time).	
Agree on the specific trunk that is being tested.	
Have the tester dial in on the new trunk.	
Answer the incoming call on a test telephone.	
Observe overall voice quality.	
Go through this checklist until all trunks are tested.	

When all of the trunks have been tested, have the telephone company's tester open the trunk group, and allow the callers to use the new trunks.

Cut-Over of Remaining Devices

Use the following checklist to test each new end-user device that is being installed.

Description	Completed
Place an internal call from the new device.	
Place an external call from the new device.	
If applicable, place a DID call.	
<p>If the device is for a user with voice mail, leave a welcome message similar to the following:</p> <p>“This is <your_name> from <company_name>. I would like to welcome you to your new, revolutionary, IP-based communications system. You will find the following materials on your desk...”</p>	
Leave a user guide on the user's desk. This provides information about the ShoreTel 7.5 system's commonly used features as well as general system information.	

Cut-Over Coverage

It is recommended that the cut-over team arrive on site before the beginning of the next business day after cut-over, to answer questions from end-users as they begin to use the ShoreTel 7.5 system.

Cut-Over Worksheet

Name	Extension/DID	ShoreGear Port #	Patch Panel #	IDF #	Station Cable #

C H A P T E R 2 0

Training

ShoreCare QuickStart is a virtual training program that is revolutionizing the way people learn to operate the ShoreTel 7.5 system. QuickStart is an innovative, no-hassle approach to preparing system administrators, operators, and users for their ShoreTel implementation.

ShoreTel is committed to ensuring that our customers have the tools and knowledge base they need to take full advantage of the new era of communication convergence. ShoreCare QuickStart fulfills that commitment.

All the courses available through ShoreCare QuickStart are provided online for your convenience. Some instruction modules include simple interactive tutorials that introduce you to basic features and configurations of your new ShoreTel 7.5 system. More advanced technical training is available via live interactive web-based sessions. In these advanced sessions you can learn about software configuration options and troubleshooting tips from an instructor providing valuable feedback for your specific issues.

For more information, please contact your ShoreTel-authorized partner or visit the ShoreCare QuickStart web center, available through www.goShoreTel.com.

Checklist

Review the following topics related to training for ShoreTel 7.5:

Task Description	See
<input type="checkbox"/> Recommendations	page 20-2
<input type="checkbox"/> Training Materials	page 20-2
<input type="checkbox"/> End-User Training	page 20-2
<input type="checkbox"/> Operator Training	page 20-2
<input type="checkbox"/> Workgroup Training	page 20-4
<input type="checkbox"/> System Administrator Training	page 20-4

Recommendations

The following recommendations will assist you with training.

- It is critical that all employees, workgroup agents/supervisors, and operators be familiar with ShoreTel services before the system is put in service.
- Be sure to consider training needs as your staff changes over time. You can return to ShoreCare QuickStart to train new employees on the use of the ShoreTel 7.5 system.

Training Materials

The following training materials are available:

- User guides and self-paced online tutorials are available through the Call Manager Help menu or from ShoreLink, ShoreTel's online knowledge base.
- System administration training and end-user training are available through a ShoreTel-authorized partner or through ShoreTel, Inc.
- Additional training materials can be downloaded from ShoreLink.

End-User Training

QuickStart offers online tutorials to familiarize end-users with the features and functionality of the ShoreWare Call Manager client. The tutorials, which are self-paced and do not require registration, highlight the commonly used features and functions available in the ShoreWare Personal Call Manager, Advanced Call Manager, Workgroup Call Manager, and Operator Call Manager. Users will learn how to install the client, answer calls, transfer a call, make conference calls, and access voice mail. A sound card and speakers are helpful but not necessary.

User training should be completed before your cut-over date.

Operator Training

Operators, receptionists, and administrative assistants have special needs and responsibilities. In addition to the Operator Call Manager tutorial, ShoreTel offers an interactive online session in which such users can learn how to maximize the power of the ShoreTel 7.5 system.

ShoreTel encourages company operators, receptionists, or administrative personnel who support multiple managers to participate in a one-hour, live interactive web session introducing the Operator Call Manager. The training covers these topics:

- Answering, transferring, and conferencing calls
- Accessing voice mail
- Using toolbar shortcuts
- Monitoring extensions
- Call routing
- Call handling modes

Class participants are able to experience a live ShoreTel 7.5 system and ask questions of the instructor.

As a prerequisite for this class, ShoreTel asks that all class participants view the Operator Call Manager tutorial.

Operator training should be completed before your cut-over date.

Workgroup Training

Workgroups, such as those in a small call center, are empowered with special features and functionality. In addition to viewing the Workgroup Call Manager tutorial, you can learn more by signing up for ShoreTel's special online training sessions on this subject.

ShoreTel encourages those customers who will be using the Workgroup Call Manager to participate in a one-hour, live interactive web session introducing the Workgroup Call Manager. These sessions are available to ShoreTel customers on a request basis and concentrate on the workgroup configuration of the requesting company.

The training covers these topics:

- Answering, transferring, and conferencing calls
- Accessing voice mail
- Using toolbar shortcuts
- Monitoring agent extensions
- Monitoring calls in the queue
- Call routing and call distribution
- Call handling modes

Class participants are able to experience a live ShoreTel 7.5 system and ask questions of the instructor. Contact your ShoreTel-authorized partner or visit the ShoreCare QuickStart web center for more information regarding course content and registration.

As a prerequisite for this class, ShoreTel asks that all class members view the Workgroup Call Manager tutorial.

Workgroup training should be completed before your cut-over date.

System Administrator Training

ShoreTel welcomes system administrators to review course content and register for an interactive training session on the ShoreWare Director software. This training complements the documentation available for the system and gives system administrators the opportunity to interact with a ShoreTel 7.5 system expert.

ShoreTel's system administration training is designed for IT professionals who will be responsible for the configuration and ongoing support of the ShoreTel 7.5 system. The training covers these topics:

- Getting started
- Setting up single-site and multisite environments
- Configuring ShoreGear switches
- Trunks
- Users
- Voice mail
- Automated attendant menus
- Workgroups

- Maintenance

The class (led by an online instructor) lasts about four hours. Participants are able to interact with a ShoreTel 7.5 system and ask questions of the instructor. Contact your ShoreTel-authorized partner or visit the ShoreCare QuickStart web center for more information regarding course content and registration.

Please register for system administration training at least three weeks before your proposed cut-over date.

Part V: Reference and Appendixes

International Planning and Installation

This chapter provides detailed information about voice switches, operating systems, and features that are supported when the ShoreTel 7.5 system is used outside the United States of America.

Software and Feature Support

The ShoreTel dialing plan is supported in the countries listed below.

Dial Plans Supported:

- **North America:** US, Canada, Mexico
- **South America:** Brazil*
- **Europe:** Austria, Belgium, Denmark, France, Germany, Ireland, Italy, Portugal, Netherlands, Norway, Spain, Sweden, Switzerland, United Arab Emirates (UAE)*, United Kingdom (UK)
- **Asia Pacific:** Australia, China*, India*, Hong Kong, Malaysia*, New Zealand, Singapore

* May not be fully supported in early ShoreTel 7.5 GA releases.

Table A-1 International Availability (Software and Features)^a

	Dialing Plan	Lang.	PCM	Local OS	Local Partner	Contact Center	Confer. Bridge	Analog CID	Fax & Modem Conn.
Australia	●	●	●	●	●	●	●	○	◐
Austria	●	◐	●	◐	○	○	●	○	○
Belgium	●	◐	●	●	●	○	◐	○	◐
Brazil*	●	○	○	●	○	○	○	○	◐
Canada	●	●	●	●	●	●	●	●	●
China*	●	◐	○	◐	○	○	○	○	○
Denmark	●	●	●	●	●	◐	◐	○	○
England-UK	●	●	●	●	●	●	●	●	●
Finland	○	◐	◐	◐	○	◐	◐	○	○
France	●	●	●	●	●	○	◐	●	◐
Germany	●	●	●	●	●	○	●	●	◐
Hong Kong	●	◐	◐	●	●	◐	◐	○	◐
Iceland	○	◐	◐	◐	○	◐	◐	○	○
India*	●	◐	◐	◐	◐	○	○	○	○
Ireland	●	●	●	●	●	●	●	●	◐
Italy	●	●	●	●	○	○	○	●	◐
Malaysia*	●	◐	◐	◐	○	◐	◐	○	◐
Mexico	●	●	●	●	●	○	○	○	○
Netherland	●	●	●	●	●	◐	◐	○	◐
Norway	●	●	●	●	○	○	○	○	○
New Zealand	●	●	●	●	●	●	●	○	◐
Pakistan	○	◐	◐	◐	○	◐	◐	○	○
Portugal	●	○	○	◐	◐	○	○	○	◐
Singapore	●	●	●	●	●	●	●	○	◐
Spain	●	●	●	●	●	◐	○	●	◐
Sweden	●	●	●	●	●	◐	◐	○	○
Switzerland	●	●	●	●	○	●	◐	○	○
United Arab Emirates*	●	◐	◐	◐	●	○	○	○	○

- a. ● = Fully available
 ◐ = Available with caveats (e.g. beta support, support for only one of many local spoken languages, etc.)
 ○ = Not available

* May not be fully supported in early ShoreTel 7.5 GA releases.

Bulleted items below refer to the columns in the preceding table:

- Dialing Plan Refers to Dialing Plan support for each country (binary value)
- Language Refers to language packs. See “Language Packs” on page A-3 for more information
- PCM Refers to support for in Personal Call Manager for one of the spoken local languages
- Local OS Refers to support for Director for one of the spoken local languages
- Local Partner Refers to whether or not a ShoreTel office/representative resides in a given country
- Contact Center Refers to whether or not Contact Center has been localized (binary value)
- Conf. Bridge Refers to whether or not Conference Bridge has been localized (binary value)
- Analog CID Refers to support for Caller ID for analog trunks. See “Analog Caller ID Support” on page A-7 for more information on Caller ID
- Fax and Modem Conn. Refers to whether or not fax and modem functionality have been fully tested in a given country

Call Managers

- All the Call Managers—the Personal Call Manager (including Outlook Integration), Advanced Call Manager, Workgroup Agent Call Manager, Workgroup Supervisor Call Manager, Operator Call Manager, and Mobile Call Manager are supported in US English. Call Managers are also supported in French, Spanish and German languages, but they must be running on an operating system of the same language.

Desktop Operating System

- The Call Managers are supported on Microsoft Windows 2003, XP Pro, and Vista desktop operating systems in the US and Canada. (Microsoft Windows 2003 and XP Pro desktop operating systems are supported worldwide.)
- Citrix and WTS are only supported in US English.

Language Packs

ShoreTel supports the following language packs:

- Chinese (simplified)
- Danish
- English (United States)
- English (United Kingdom)
- Dutch

- German
- French
- Norwegian
- Spanish (CALA - Central American and Latin America)
- Spanish (Castilian)
- Swedish

Language packs within the ShoreTel system define the language used in the following three independent parts:

- Voice prompts (Voice mail, Auto Attendant, system announcements)
- Telephone User Interface (telephone display and call manager interface)
- Online help for call manager applications

Language pack availability affects the behavior of the system in the following areas:

- Site
- Trunk
- Workgroup
- Auto Attendant
- Voice Mail
- User
- PCM

Details:

- **Site** – Determines which language is used for the Backup Auto-Attendant (BAA) (see Figure A-1)
- **Workgroup** – Determines which language is used for prompts played to incoming callers (see Figure A-2)
- **Trunk** – Determines which language prompts are played to incoming callers (see Figure A-3)
- **User** – Determines which language is used for a user's telephone interface and voicemail prompts (see Figure A-4)
- **Personal Call Manager (PCM)** – Depends on the language of the operating system

Note: In terms of language priority, a workgroup language overrides the language associated with a trunk, which in turn overrides the language associated with an individual user.

Figure A-1 Language set at Site level

The screenshot shows the 'Sites' configuration page. At the top, there are buttons for 'New', 'Copy', 'Save', 'Delete', and 'Reset'. Below these is a table with columns for 'Edit this record' and 'Refresh this page'. The table contains the following information:

Name:	Remote_Site
Country:	Australia
Language:	English(UK)
Parent:	Headquarters

The 'Language' field is circled in red, indicating it is the focus of the figure.

Figure A-2 Language set at Workgroup level

Workgroups [New](#) [Copy](#) [Save](#) [Delete](#) [Reset](#) [Help](#)

Edit Workgroup * modified

Edit this record [Refresh this page](#)

Name:

Extension:

Backup Extension: [Search](#)

DID: (DID Range: +14089621320 - 21334)

DNIS: [Edit DNIS Map](#)

User Group:

Mailbox (server) [Escalation Profiles and Other Mailbox Options](#)

Language:

- English(US)
- Spanish(Spain)
- German
- English(UK)
- French
- Dutch
- Spanish(CALA)
- Danish
- Italian
- Swedish
- Chinese(Simplified)

Accept Broadcast Messages

Include in System Dial By Name Direct

Make Number Private

Recorded Name: [Import](#)

Voice Mail Password:

Enable Automatic Agent Logout on Ring No Answer

Figure A-3 Language set at Trunk Group level

Trunk Groups [New](#) [Copy](#) [Save](#) [Delete](#) [Reset](#) [Help](#)

Edit T1 PRI Trunk Group

Edit this record [Refresh this page](#)

Name:

Site:

Language:

- English(US)
- Spanish(Spain)
- German
- English(UK)
- French
- Dutch
- Spanish(CALA)
- Danish
- Italian
- Swedish
- Chinese(Simplified)

Inbound:

Number of Digits from CO:

DNIS

DID

Extension

Translation Table:

Prepend Dial In Prefix:

Use Site Extension Prefix

Figure A-4 Language set at User level

Users [Help](#)
Edit User

* modified [Refresh this page](#)

General | Personal Options | Distribution Lists | Workgroups

First Name:
Last Name:
Number:
License Type:
Caller ID: (e.g. +1 (408) 331-3300)
 DID: (DID Range: +14083313916 - 3939)
PSTN Failover:
User Group: [Go to this User Group](#)

Site:
Language:
Home Port:
Current Port:
Jack #:

- Spanish(Spain)
- German
- English(UK)
- French
- Dutch
- Spanish(CALA)
- Danish
- Italian
- Swedish
- Chinese(Simplified)
- Norwegian

Analog Caller ID Support

Table A-2 Detailed International Support for Analog Caller ID^{abc}

	Bell core	Sin 227 Sin 242	ETSI (EN 300 659 - FSK)
Australia	✓		
Canada	✓		
England-UK		✓	
France			✓
Germany			✓
Ireland		✓	
Italy			✓
New Zealand	✓		
Spain			✓
United States	✓		

- a. This release offers support for Caller ID Name, Caller ID Number and Message-Waiting Indication (MWI) on analog phones (Type 1/on-hook) in the countries listed above.
- b. Analog caller ID is only supported on the subscriber side outside of the US and Canada.
- c. IP Phones support Caller ID Name, Caller ID Number, and MWI in all countries.

Hardware Support

Voice Switches

- The SG-T1, SG-220T1 and SG-220T1A are supported in the US, Canada and Hong Kong. Outside of these regions, the SG-E1 and SG-220E1 are supported for both central office and tie trunk applications.¹
- The SG-50 and SG-90 are supported on the analog trunk side in the CE zone, Mexico, US and Canada.
- See Table A-3 on page 9 for details.

International Trunking

- In the international market, EuroISDN over PRI/BRI is supported. Analog Trunk support is offered for EMEA countries, but Channel Associated Signaling using E1 is not supported.

SIP Gateways

SIP Gateways may be available depending on the region. Please check on the ShoreTel Partner's website for the latest additions to the ShoreTel Technology Partner Program.

E1 PRI

The ShoreGear-E1 and ShoreGear-220E1 voice switches support Euro-ISDN PRI over E1, as specified in ETS TBR4 (ETSI's European Telecommunications Standard, Technical Basis for Regulation, TBR4).

NOTE When provisioning with the local carrier, be sure to order Euro-ISDN signaling and not the older ISDN signaling.

BRI

The ShoreGear SIP-BRI 8 and SG-90BRI voice switches support Euro-ISDN BRI, as specified in ETS TBR3 (ETSI's European Telecommunications Standard, Technical Basis for Regulation, TBR3).

NOTE When provisioning with the local carrier, be sure to order Euro-ISDN signaling and not the older ISDN signaling.

Analog Telephones, Tones, Cadences, and Impedances

For all supported countries, standard analog telephones are available on a per-country basis. The main difference between telephones in different countries is the line impedance. The ShoreWare Distributed Call Control software will provide the appropriate impedance required for each supported country. Tones, cadences, and impedance requirements are matched on a per-country basis.

1. The SG-E1 and SG-220E1 may not both be available in a given country. Please check with your ShoreTel Regional Sales Manager for details on availability in your region.

Hardware Availability Summary

The table below summarizes the homologation status of the hardware (voice switches) in a given country.

Homologation refers to the process of getting approval to sell a product in any country. The term applies to dishwashers, electronics, toasters, any other products. Because ShoreGear voice switches connect directly to PSTN networks, requirements exist to prevent the voice switch from causing a mishap within the system. There are also EMC requirements to verify that radio wave leaks from a piece of hardware will not cause problems with other electronic devices. In the USA, for instance, testing is required by the FCC to ensure that circuit boards do not interfere with other devices, such as pacemakers and television sets. There are also tests to determine things like flammability and electrical safety.

Table A-3 International Availability (ShoreGear Switches)^a

	SG T1	SG E1	SG SIP BR18	SG 40/8	SG 50	SG 60/12	SG 90	SG 90 BRI	SG 120/24	SG 220T1	SG 220E1
Australia	○	●	●	◐	●	◐	●	○	◐	○	○
Austria	○	●	●	◐	●	◐	●	◐	◐	○	◐
Belgium	○	●	●	◐	●	◐	●	◐	◐	○	◐
Brazil*	○	○	○	○	○	○	○	○	○	○	○
China*	○	○	○	○	●	○	●	○	◐	○	●
Canada	●	○	○	●	●	●	●	○	●	●	○
Denmark	○	●	●	◐	●	◐	●	◐	◐	○	◐
England-UK	○	●	●	◐	●	◐	●	◐	◐	○	◐
Finland	○	●	●	◐	●	◐	●	◐	◐	○	◐
France	○	●	●	◐	●	◐	●	◐	◐	○	◐
Germany	○	●	●	◐	●	◐	●	◐	◐	○	◐
Iceland	○	●	●	◐	●	◐	●	◐	◐	○	◐
India*	○	○	○	○	◐	○	◐	○	◐	○	●
Ireland	○	●	●	◐	●	◐	●	◐	◐	○	◐
Italy	○	●	●	◐	●	◐	●	◐	◐	○	◐
Malaysia*	○	○	○	○	○	○	○	○	○	○	○
Mexico*	○	○	○	○	●	○	●	○	◐	○	●
Netherland	○	●	●	◐	●	◐	●	◐	◐	○	◐
New Zealand	○	●	●	◐	●	◐	●	○	◐	○	○

Table A-3 International Availability (ShoreGear Switches)^a

	SG T1	SG E1	SG SIP BRI8	SG 40/8	SG 50	SG 60/12	SG 90	SG 90 BRI	SG 120/24	SG 220T1	SG 220E1
Norway	○	●	●	◐	●	◐	●	◐	◐	○	◐
Portugal	○	●	●	◐	●	◐	●	◐	◐	○	◐
Singapore	○	◐	○	◐	○	◐	○	○	◐	○	○
Spain	○	●	●	◐	●	◐	●	◐	◐	○	◐
Sweden	○	●	●	◐	●	◐	●	◐	◐	○	◐
Switzerland	○	●	●	◐	●	◐	●	◐	◐	○	◐
United Arab Emirates*	○	○	○	○	○	○	○	○	○	○	○
United States of America	●	○	○	●	●	●	●	○	●	●	○

- a. ● = Fully available
 ◐ = Available with caveats. (e.g. analog trunk not supported for voice switches, feature in beta stage, etc.) Please contact your area sales manager for clarification.
 ○ = Not available

* May not be fully supported in early ShoreTel 7.5 GA releases.

The table below summarizes the homologation status of the hardware (IP phones) in a given country.

Table A-4 International Availability (ShorePhone IP Phones)^a

	IP 110	IP 115	IP 210	IP 212k	IP 230	IP 530	IP 560	IP 560g		
Australia	●	N/A	●	●	●	N/A	●	●	○	N/A
Austria	●	N/A	●	●	●	N/A	●	●	●	N/A
Belgium	●	N/A	●	●	●	N/A	●	●	●	N/A
Brazil	○	N/A	○	○	○	N/A	○	○	○	N/A
China*	●	●	N/A	●	●	N/A	N/A	●	●	N/A
Canada	●	N/A	●	●	●	N/A	●	●	●	N/A
Denmark	●	N/A	●	●	●	N/A	●	●	●	N/A
England-UK	●	N/A	●	●	●	N/A	●	●	●	N/A
Finland	●	N/A	●	●	●	N/A	●	●	●	N/A

Table A-4 International Availability (ShorePhone IP Phones)^a

	IP 110	IP 115	IP 210	IP 212k	IP 230		IP 530	IP 560	IP 560g	
France	●	N/A	●	●	●	N/A	●	●	●	N/A
Germany	●	N/A	●	●	●	N/A	●	●	●	N/A
Iceland	●	N/A	●	●	●	N/A	●	●	●	N/A
India*	○	N/A	○	●	●	N/A	○	●	●	N/A
Ireland	●	N/A	●	●	●	N/A	●	●	●	N/A
Italy	●	N/A	●	●	●	N/A	●	●	●	N/A
Malaysia*	○	N/A	○	○	○	N/A	○	○	○	N/A
Mexico*	●	N/A	N/A	●	●	N/A	N/A	●	●	N/A
Netherland	●	N/A	●	●	●	N/A	●	●	●	N/A
New Zealand	●	N/A	●	●	●	N/A	●	●	○	N/A
Norway	●	N/A	●	●	●	N/A	●	●	●	N/A
Portugal	●	N/A	●	●	●	N/A	●	●	●	N/A
Singapore	●	●	●	●	●	N/A	●	●	●	N/A
Spain	●	N/A	●	●	●	N/A	●	●	●	N/A
Sweden	●	N/A	●	●	●	N/A	●	●	●	N/A
Switzerland	●	N/A	●	●	●	N/A	●	●	●	N/A
United Arab Emirates	●	●	N/A	●	●	N/A	N/A	●	●	N/A

- a. ● = Fully available
 ◐ = Available with caveats. (e.g. analog trunk not supported for voice switches, feature in beta stage, etc.) Please contact your area sales manager for clarification.
 ○ = Not available

* May not be fully supported in early ShoreTel 7.5 GA releases.

Summary

The tables below summarize the international level of support for hardware and software, and provide a third column that consolidates this information into an “overall level of support” for each country. Countries are divided between the tables based on the following regions: Americas (South America and North America), Asian Pacific (APAC), Europe and the Middle East and Africa (EMEA).

Table A-5 Summary of Hardware and Software^a Availability – Americas

	Hardware	Software and Features	Country Status ^b
Brazil	○	○	○
Canada	●	●	●
Mexico	◐	◐	◐

- a. ● = Fully available
 ◐ = Available with caveats
 ○ = Not available
- b. Country Status refers to the overall level of support for a country when taking into account both hardware, software and presence of a local certified partner or technician.

Table A-6 Summary of Hardware and Software Availability^a – APAC

	Hardware	Software and Features	Country Status ^b
Australia	◐	●	●
China	◐	○	○
Hong Kong	◐	◐	◐
Malaysia	○	◐	○
New Zealand	◐	●	●
Singapore	◐	◐	◐

- a. ● = Fully available
 ◐ = Available with caveats
 ○ = Not available
- b. Country Status refers to the overall level of support for a country when taking into account both hardware, software and presence of a local certified partner or technician.

Table A-7 Summary of Hardware and Software^a Availability – EMEA

	Hardware	Software and Features	Country Status ^b
Austria	◐	◐	◐
Belgium	◐	◐	◐
Denmark	◐	◐	◐
England-UK	◐	●	●
Finland	◐	○	○
France	◐	●	●
Germany	◐	●	●
Iceland	◐	○	○
India	◐	◐	◐
Ireland	◐	●	●
Italy	◐	◐	◐
Netherland	◐	●	●
Norway	◐	◐	◐
Portugal	◐	◐	◐
Spain	◐	●	●
Sweden	◐	◐	◐
Switzerland	◐	◐	◐
United Arab Emirates	○	◐	○

- a. ● = Fully available
 ◐ = Available with caveats
 ○ = Not available
- b. Country Status refers to the overall level of support for a country when taking into account both hardware, software and presence of a local certified partner or technician.

Dialing Plan Considerations

When planning a global voice network, remember that the ShoreTel 7.5 system is a single image system and that you must consider all countries and locations when designing the international dialing plan. The ShoreTel 7.5 system can match the dialing plan requirements of the local service provider for the countries listed within this chapter on page A-1.

Single-Extension Plan

Across the global voice network, all extensions must be unique and cannot overlap.

Trunk Access Codes

Across the global voice network, when you configure trunk access codes, that portion of the dialing plan will be reserved so you will be sacrificing one digit. Typically in the US, customers use 9 as a trunk access code. Internationally, those in the EMEA, for instance, often use 0 as a trunk access code.

- Using two different trunk access codes will limit users to only being able to access certain trunk groups.
- If you use a single trunk access code, some users will need to be retrained.
- Alternatively, 8 could be defined for the trunk access code globally.

NOTE ShoreTel recommends proper identification **from the beginning**. The trunk access code should not be changed later.

Operator Digit

The leading digit of 0 is typically reserved for dialing the operator in the US. The operator digit is configurable. Similarly, EMEA customers are accustomed to dialing 9 to reach the operator.

NOTE ShoreTel recommends choosing a single digit for the trunk access code and selecting a different single digit for the operator.

Emergency Numbers

The ShoreTel 7.5 system allows dialing of emergency numbers with and without trunk access codes. For this reason, you should architect the dialing plan for this feature.

- 911 is used in the US.
- 112 is used in Europe and other countries.
- Check for Asia per local requirements.

Thus, extensions should not begin with 0, 1, or 9 to make use of this feature.

Each site can have a maximum of ten emergency numbers to accommodate locations where multiple emergency service numbers are required.

For more information about emergency numbers, see “Emergency 911 Operations” appendix in the *ShoreTel 7.5 Administration Guide*.

DID Numbers

DID numbers are related to the trunk group in which they are associated. You should strive to match the last digits of the DID number to the user's extension number.

A P P E N D I X 2

Regulatory and Safety Information

This chapter provides detailed information regarding compliance of the ShoreTel system with the international regulatory bodies. The chapter also addresses safety concerns related to installation, operation and general use of the ShoreTel 7.5 system.

Agency Approvals

Table B-1 Agency approvals

Category	Regulatory Compliance / Agency Approval
EMC	EN 55022 Class A (SG-12, SG-8, SG-24, SG-T1)
	EN 55022 Class B/Class A (SG-E1)
	FCC Part 15 Class A (SG-12, SG-8, SG-24, SG-T1)
	EN 55024:1998 including amendments A1:2001 and A2:2003 (SG-24, SG-E1)
Electrical Safety	FCC Part 68 for SG-24, SG-T1
	IEC 60950:1999 3rd ed. SG-8, SG-12, SG-24, SG-T1, SG-E1
	EN60950:2000 SG-8, SG-24, SG-T1, SG-E1

Table B-1 Agency approvals

Category	Regulatory Compliance / Agency Approval
	AS/NZ 60950:2000 SG-8, SG-24, SG-T1, SG-E1
	UL60950 3rd ed. 2000 SG-8, SG-12, SG-24, SG-T1, SG-E1
	ACA TS001-1997: SG-8, SG-24, SG-T1, SG-E1
	FCC Part 68 : SG-8, SG-12, SG-24
Telecom	ETSI TS 103 021-1 V1.1 (2003-08) SG-8, SG-12, SG-24
	ETSI TS 103 021-2 V1.2 (2003-09) SG-8, SG-12, SG-24
	ETSI TS 103 021-3 V1.2 (2003-09) SG-8, SG-12, SG-24
	ETSI TBR4 Nov. 1995 SG-E1
	ETSI TBR4/A1 Dec. 1997 SG-E1
	ETSI TS 102 119 V1.1.1 Aug. 2001 SG-E1
	Bellcore GR-499-CORE, issue 2, Dec. 1998 SG-T1
Telecom Homologation	NZ PTC 220/06/016 through PTC 220/06/023 SG-8, SG-12, SG-24, SG-T1, SG-E1 and IP 210/530/560 Phones

EMC Compliance Statements (SG-8/12/24 and T1)

United States

This equipment has been tested and found to comply with the limits for Class A digital devices, pursuant to part 15 of the FCC Rules. These limits are designed to provide reasonable protection against harmful interference when the equipment is operated in a commercial environment. This equipment generates, uses, and can radiate radio frequency energy and, if not installed and used in accordance with the instruction manual, may cause harmful interference to radio communications. Operation of this equipment in a residential area is likely to cause harmful interference in which case the user will be required to correct the interference at his own expense.

Changes or modifications to this equipment not expressly approved by the party responsible for compliance to FCC part 15 could void the user's authority to operate the equipment.

European Union

This is a Class A product. In a domestic environment this product may cause radio interference in which case the user may be required to take adequate measures.

Canada

This Class A digital apparatus complies with Canadian ICES-003. Cet appareil numérique de la classe A est conforme à la norme NMB-003 du Canada.

Restricted Access Location

This product is intended to be installed only in a RESTRICTED ACCESS LOCATION. A RESTRICTED ACCESS LOCATION is defined as an area where access can be gained only by SERVICE PERSONNEL who have been instructed about the reasons for the restrictions applied to the location and about any precautions that must be taken. RESTRICTED ACCESS LOCATIONS can be accessed only through the use of a tool or lock and key or other means of security, and are controlled by the authority responsible for the location. SERVICE PERSONNEL are defined as persons having appropriate technical training and experience necessary to be aware of hazards to which they are exposed in performing a task and of measures to minimize the danger to themselves or other persons.



WEEE Information

In accordance with the requirements of council directive 2002/96/EC on Waste of Electrical and Electronic Equipment (WEEE), ensure that at end-of-life you separate this product from other waste and scrap and deliver to the WEEE collection system in your country for recycling.

Safety

The following information is included in this publication for the use and safety of installation and maintenance personnel.

NOTE This equipment uses a three-conductor power cord with safety grounding conductor. Ensure that this is connected to an AC outlet with provision for grounding. Ensure the permanent earthing protector is connected as directed in the installation instructions. Consult a licensed electrician if necessary.

Important Safety Instructions

- Read all of the instructions before attempting to operate the equipment and before connecting the power supply.
- Always follow basic safety precautions to reduce the risk of fire, electrical shock, and injury to persons.

- To prevent fire or shock hazard, do not expose the unit to rain, moisture, or install this product near water. Never spill liquid of any kind on this product.
- Never push objects of any kind into this product through openings, as they may touch dangerous voltage points or short out parts, which could result in the risk of fire or electrical shock.
- Do not open the cabinet, as there are high voltage components inside. Refer servicing to qualified service personnel.
- Do not attach the power supply cord to building surfaces. Do not allow anything to rest on the power cord or allow the cord to be abused by persons walking on it.
- To protect this equipment from overheating, do not block the openings in the housing that are provided for ventilation.

Electrical Safety

WARNING Do not take chances with your life. Follow these guidelines carefully:

- Observe all safety regulations and read the warnings, cautions, and notes posted on the equipment.
- Never assume that the power is turned off. Always check to ensure that a circuit does not have power.
- Connect all power before installing changes in systems or wiring.
- Use caution when installing or modifying telephone lines. Never install telephone wiring during an electrical storm.
- Never touch uninsulated telephone wires or terminals unless the telephone line has been disconnected at the network interface.
- Telephone connections to the unit should be made with number 26 AWG wire in order to minimize risk of fire.

A P P E N D I X C

ShoreGear IPBX Voice Switches

This appendix provides information about the ShoreGear-24 (IPBX-24), ShoreGear-12 (IPBX-12), ShoreGear-Teleworker (IPBX-TW), and ShoreGear-T1 (IPBX-T1). Use this information to plan rack space and cabling.

NOTE These switches are no longer sold. If you have purchased one of these models, please check the ShoreCare website for End of Life documentation and support.

The following chart shows which legacy IPBX voice switches are available for select countries.

	IPBX-E1		IPBX-T1		IPBX-24	
	CO	Tie	Tele	Trunks	Tele	Trunks
North America						
— US	—	—	x	x	x	x
— Canada	—	—	x	x	x	—
South America						
— Brazil	x	x	—	—	x	—
Europe						
— France	x	x	—	—	x	—
— Germany	x	x	—	—	x	—
— Ireland	x	x	—	—	x	—
— Italy	x	x	—	—	x	—
— Netherlands	x	x	—	—	x	—
— Portugal	x	x	—	—	x	—
— Spain	x	x	—	—	x	—
— UK	x	x	—	—	x	—
Asia Pacific						
— Australia	x	x	—	—	x	—
— Hong Kong	—	—	x	x	x	—
— Malaysia	x	x	—	—	x	—
— Singapore	x	x	—	—	x	—

Voice Switch Requirements

This section includes requirements for mounting the IPBX ShoreGear voice switches, along with other switch-related requirements and specifications.

Physical Requirements

The ShoreGear voice switches are designed to be mounted in a standard rack. Table C-1 shows the specifications for each voice switch. Refer to the *Quick Install Guide* included with each ShoreGear voice switch for more information.

Table C-1 ShoreGear Voice Switch Physical Specifications

Parameter	ShoreGear-24	ShoreGear-12	ShoreGear-Teleworker	ShoreGear-T1
Dimensions (W x H x D)	17.2" x 3.1" x 14.3" 437 x 79 x 363 mm	13.75" x 2.5" x 11.25" 350 x 64 x 286 mm	13.75" x 2.5" x 11.25" 350 x 64 x 286 mm	13.75" x 2.5" x 11.25" 350 x 64 x 286 mm
Rack mount units ^a	2U	1.5U	1.5U	1.5U
Mounting position	Front, Center	Front	Front	Front, Center
Weight	15 lbs 6.8 kg	10 lbs 4.5 kg	10 lbs 4.5 kg	10 lbs 4.5 kg
Maximum stacked per shelf	3 switches	3 switches	3 switches	3 switches

a. Assumes a standard 19-inch rack and that the rubber feet on the voice switches have been removed.

Input Power

For backup purposes, ShoreTel recommends that all ShoreGear voice switches and the ShoreWare server be connected to an uninterruptable power supply (UPS). This ensures that telephone service will continue in the event of a power interruption. Table C-2 shows the power requirements for the ShoreGear voice switches.

Table C-2 ShoreGear Voice Switch Input Power

Parameter	ShoreGear-24	ShoreGear-12	ShoreGear-Teleworker	ShoreGear-T1
Input voltage	100–240 VAC 50–60 Hz	100–240 VAC 50–60 Hz	100–240 VAC 50–60 Hz	100–240 VAC 50–60 Hz
Current consumption @110 VAC (maximum)	1.35A max	0.75A max	0.75A max	0.75A max
Number of grounded 110 VAC outlets per switch	1	1	1	1
Power consumption (typical)	90W typ	50W typ	50W typ	50W typ

Power and Heat Dissipation

The voice switches dissipate power and heat. ShoreTel recommends that you use the information provided in Table C-3 to help calculate the ventilation requirements of the equipment room.

Table C-3 ShoreGear Voice Switch Power and Heat Dissipation

Parameter	ShoreGear-24	ShoreGear-12	ShoreGear-Teleworker	ShoreGear-T1
Power dissipation (typical)	90 W typ	50 W typ	50 W typ	50 W typ

Table C-3 ShoreGear Voice Switch Power and Heat Dissipation

Heat Dissipation	307 BTU/hour typ	171 BTU/hour typ	171 BTU/hour typ	171 BTU/hour typ
------------------	------------------	------------------	------------------	------------------

Environmental Requirements

The ShoreGear voice switches require that the environmental specifications provided in Table C-4 be met.

Table C-4 ShoreGear Voice Switch Environmental Specifications

Parameter	Specification
Operating temperature	0° C to 50° C
Operating humidity (non-condensing)	10% to 90%
Storage temperature	-30° C to 70° C

Reliability and Availability

Each ShoreGear voice switch is an embedded product with no moving parts other than a highly reliable fan. In addition, the power supply contained within the voice switch has a very high individual mean time between failure (MTBF), as shown in Table C-5.

Table C-5 ShoreGear Voice Switch Dependability

Voice Switch	MTBF (hours)	MTTR (minutes)	Availability
ShoreGear-24	72,698	60	99.999%
ShoreGear-12	85,619	60	99.999%
ShoreGear-Teleworker	116,490	60	99.999%
ShoreGear-T1	97,209	60	99.999%

Since the ShoreTel 7.5 system is plug-and-play, a voice switch can be replaced in a few minutes.

Thanks to the distributed call control software of the ShoreTel 7.5 system, there is no system-wide single point of failure. If a single ShoreGear voice switch fails, all the other voice switches continue to operate.

Connectors

Table C-6 summarizes all of the connectors on the ShoreGear voice switches. Diagrams showing where these connectors are located are provided later in this chapter.

Table C-6 ShoreGear Voice Switch Connectors

Port/Connector	ShoreGear-24	ShoreGear-12	ShoreGear-Teleworker	ShoreGear-T1
Power	110 VAC	110 VAC	110 VAC	110 VAC
Ethernet	RJ-45	RJ-45	RJ-45	RJ-45

Table C-6 ShoreGear Voice Switch Connectors

Analog telephone/trunk	RJ-11 x 24 RJ-21X male 0–2,000 feet*	RJ-11 x 12 RJ-21X male 0–2,000 feet*	RJ-11 x 4 — 0–2,000 feet*	— — —
T1 trunk	—	—	—	RJ-48C
T1 trunk monitor	—	—	—	RJ-48C
Audio input (Music on Hold)	3.5 mini-mono	3.5 mini-mono	3.5 mini-mono	—
Audio output (Paging, Night Bell)	3.5 mini-mono	3.5 mini-mono	3.5 mini-mono	—
Maintenance	DB-9 female	N/A	N/A	DB-9 female

* 2000 ft. length uses 26AWG wire.

Power Cabling

Each ShoreGear voice switch comes equipped with a standard 110 VAC modular power cord. A localized modular power cord can be ordered from ShoreTel. ShoreTel recommends that every ShoreGear voice switch, as well as the ShoreWare server, be connected to an uninterruptable power supply (UPS).

Ethernet Cabling

Each ShoreGear voice switch has an RJ-45 connector that provides an auto-sensing 10/100M Ethernet interface. This is connected to the local area network using standard Category 5 cabling.

10 Base-T can typically support up to 150 meters, while 100 Base-T can support up to 100 meters.

IP Phone Cabling

Each ShorePhone IP phone has an RJ-45 connector that provides an auto-sensing 10/100M Ethernet interface. This is connected to the local area network using standard Category 5 cabling.

10 Base-T can typically support up to 150 meters, while 100 Base-T can support up to 100 meters.

Analog Telephone and Trunk Cabling

The ShoreGear-24, ShoreGear-12, and ShoreGear-Teleworker, voice switches have RJ-11 connectors that provide telephone and trunk interfaces. These should be connected using standard Category 3 twisted-wire cabling or better.

In addition, the ShoreGear-24 and ShoreGear-12 provide an RJ-21X male connector as an alternative for mass termination of the telephones and trunks. This should be connected using a standard 25-pair cable. ShoreTel recommends using the RJ-21X and connecting to a patch panel to provide simple moves, adds, and changes.

Telephones can be supported from 0 to 2,000 feet from the voice switch over standard cabling. Use larger gauge wires for longer distances. For example, with a ShoreGear-12 and #22AWG wire, you can obtain loop lengths of over 6,000 feet.

NOTE It is recommended that an analog telephone be provisioned in the equipment room for troubleshooting purposes.

The pinout of the ShoreGear-24 and ShoreGear-12 RJ-21X connectors are shown in the section “Connector Pinouts” on page C-14.

T1 Trunk and Trunk Monitor Cabling

The ShoreGear-T1 voice switches have an RJ-48C connector as the telco interface to the T1 trunk from the telephone service provider.

NOTE These voice switches provide an internal Channel Service Unit (CSU).

The ShoreGear-T1 have an additional RJ-48C connector that is wired to the telco interface for the purpose of troubleshooting the T1 interface with specialized test equipment. This connector is normally not used.

Audio Input (Music on Hold) Cabling

The ShoreGear-24, ShoreGear-12, and ShoreGear-Teleworker voice switches each have a 3.5 mm mini-mono input connector that provides music or some other recording to callers when they are on hold. The input port supports low-level line audio from a preamplifier or mini-CD player, at 47 k Ω nominal impedance. The audio input cable can be up to 10 feet long.

The audio input port on the ShoreGear voice switches is a mono connection. If you connect a stereo input, the stereo signal is converted to a mono signal.

To minimize bandwidth, music on hold is not streamed across the wide area network, so you will need one music source per site.

NOTE The music and music source are not included with the ShoreTel 7.5 system.

WARNING In accordance with United States copyright laws, a license may be required from the American Society of Composers, Authors, and Publishers, or a similar organization, if radio or TV broadcasts are played for music on hold. As an alternative, an ASCAP-approved CD or tape can be used. ShoreTel, Inc. disclaims any liability out of failure to obtain such a license.

Audio Output (Paging and Night Bell) Cabling

The ShoreGear-24, ShoreGear-12, and ShoreGear-Teleworker voice switches each have a 3.5 mm mini-mono audio output connector for overhead paging and night bell on a per site basis. The audio output port provides low-level line audio with a sufficient input level for a typical amplifier. The paging port output is about one volt peak to peak, similar to the line output of a CD player, and can drive inputs that are 600 ohms or higher.

The audio output is mono signal. If you use a stereo jack, the signal is available on one channel, but the other channel will be silent.

This is a single-zone paging system. If more zones are required, see the application note on ShoreLink, ShoreTel’s online knowledge base.

Maintenance Cabling

The ShoreGear-24 and ShoreGear-T1 voice switches support a maintenance port for connection terminal using a standard DB-9 female connector. This maintenance port is typically used only when assigning networking parameters if DHCP or BOOTP is not being used.

ShoreGear-24 Connectors

The ShoreGear-24 voice switch (Figure C-1) contains the following components:

- 1 3.5 mm mono connector for audio input (music on hold)
- 1 3.5 mm mono connector for audio output (overhead paging and night bell)
- 1 DB-9 female connector for maintenance
- 1 RJ-45 connector for the LAN interface
- 24 RJ-11 connectors for the trunk and telephone ports:
 - 8 universal telephone/trunk ports (Ports 1 through 8)
 - 16 telephone ports (Ports 9 through 24)
 - Power fail transfer (between Ports 8 and 9)
- 1 RJ-21X male connector for mass termination of the telephone/trunk ports

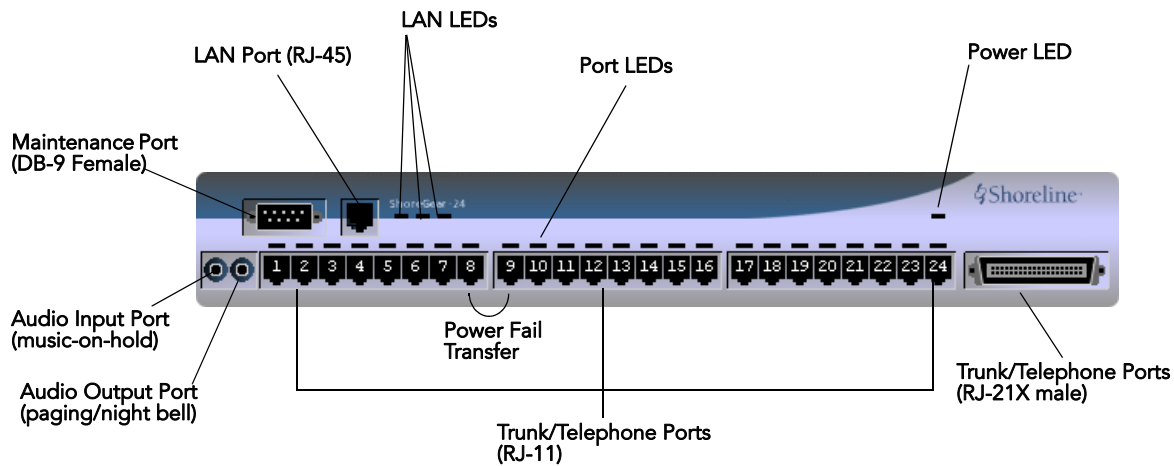

Figure C-1 ShoreGear-24 Connectors and LEDs

ShoreGear-12 Connectors

The ShoreGear-12 voice switch (Figure C-2) contains the following components:

- 1 3.5 mm mono connector for audio input (music on hold)
- 1 3.5 mm mono connector for audio output (overhead paging and night bell)
- 1 RJ-45 connector for the LAN interface
- 12 RJ-11 connectors for the trunk and telephone ports:
 - 12 universal telephone/trunk ports (Ports 1 through 12)
 - Power fail transfer (between Ports 1 and 2)
- 1 RJ-21X male connector for mass termination of the telephone/trunk ports

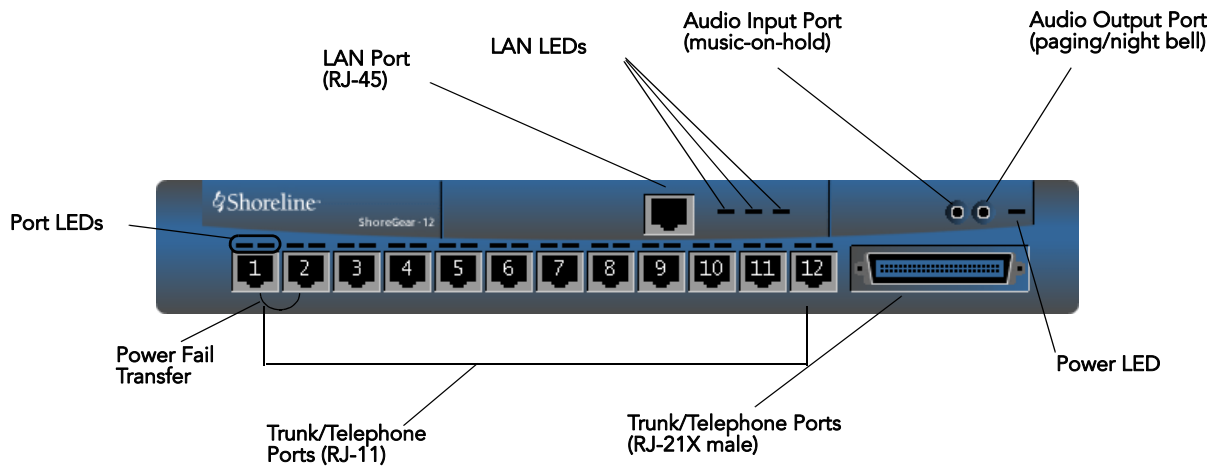

Figure C-2 ShoreGear-12 Connectors and LEDs

ShoreGear-Teleworker Connectors

The ShoreGear-Teleworker voice switch (Figure C-3) contains the following components:

- 1 3.5 mm mono connector for audio input (music on hold)
- 1 3.5 mm mono connector for audio output (overhead paging and night bell)
- 1 RJ-45 connector for the LAN interface
- 4 RJ-11 connectors for the trunk and telephone ports:
 - 4 universal telephone/trunk ports (Ports 1 through 4)
 - Power fail transfer (between Ports 1 and 2)
- 4 ports for connections to any combination of trunk and telephone lines

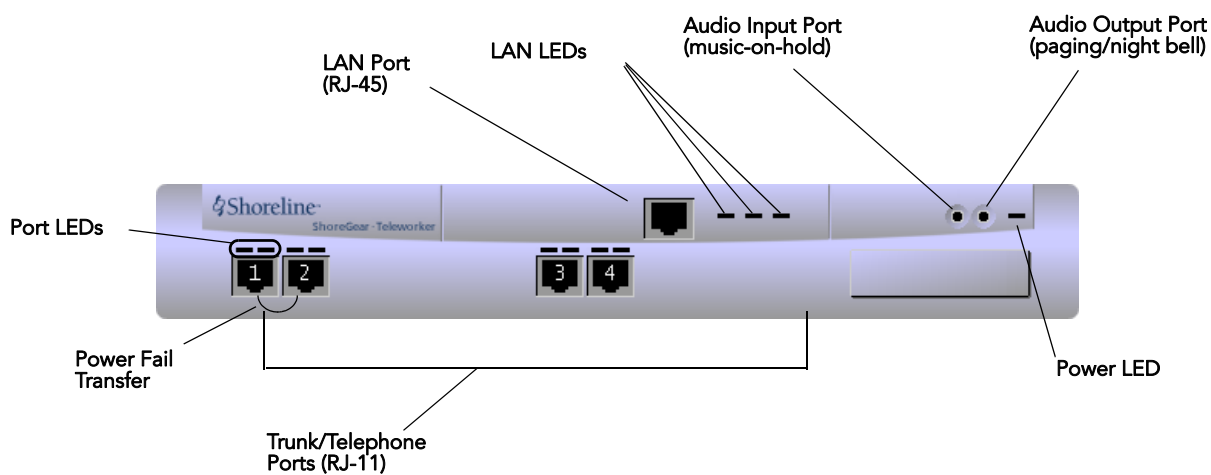

Figure C-3 ShoreGear-Teleworker Connectors and LEDs

ShoreGear-T1 Connectors

The ShoreGear-T1 and voice switches (Figure C-4) contain the following components:

- 1 DB-9 female connector for maintenance
- 1 RJ-45 connector for the LAN interface
- 1 RJ-48C connector for T1 monitoring
- 1 RJ-48C connector for the T1 interface

NOTE The ShoreGear-T1 and provide an internal Channel Service Unit (CSU).

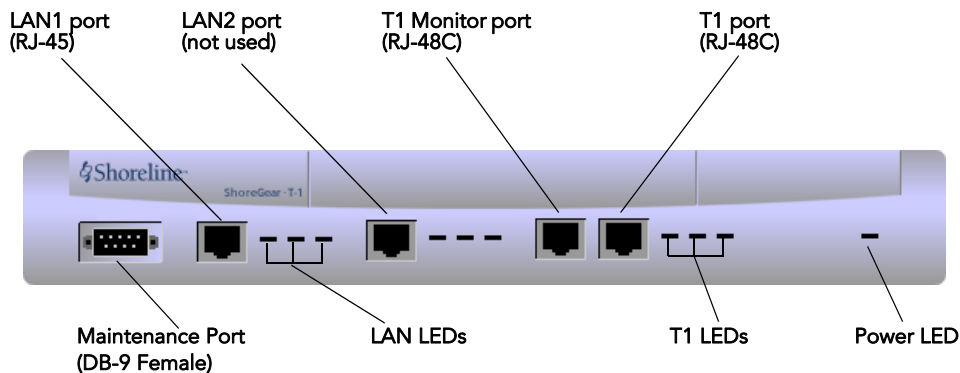

Figure C-4 ShoreGear-T1 Connectors and LEDs

Racks and Cabling

General Cabling Overview

The diagram in Figure C-5 highlights the key components with respect to cabling for your voice network.

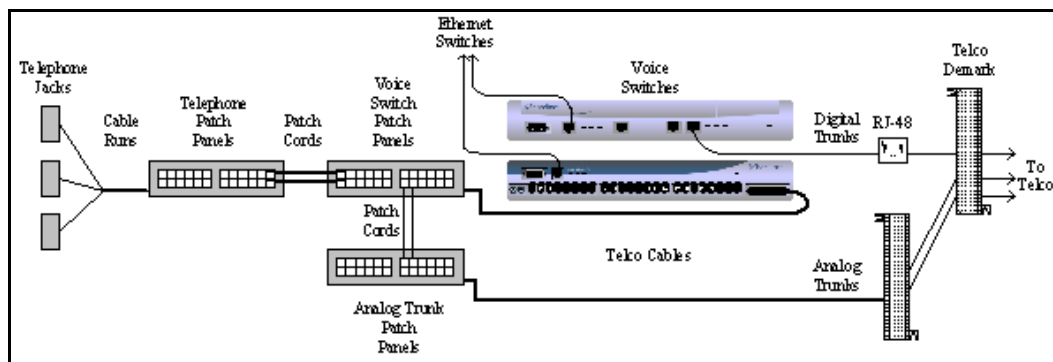

Figure C-5 Cabling Overview

Starting from the left in this diagram, the telephone cabling is organized as follows:

- A telephone jack (RJ-11) is provided for each telephone.
- Telephone cabling (Category 3 or better) is terminated on the telephone jack and runs back to the equipment room to a modular connector (RJ-21X) on a telephone patch panel.
- The telephone patch panel provides a flexible cable management solution for the telephone cabling. The patch panel has RJ-21X connections for the telephone cabling and RJ-11 connections on the front.
- Patch cords are connected from the telephone patch panel (RJ-11) to the voice switch patch panel (RJ-11).
- The voice switch patch panel provides a flexible cable management solution for the voice switches. The patch panel has RJ-21X connections running to the voice switches and RJ-11 connections on the front.

Starting from the right in Figure C-5, the trunk cabling is organized as follows:

- The digital (T1) and analog trunks are terminated on a punch-down block.
- The digital service is further terminated at a service provider demark with an RJ-48 connector.

An RJ-48 cable from the T1 demark connects to the ShoreGear-T1.

- The analog service is cross-connected to a modular (RJ-21X) punch-down block.

A telco cable is connected to the modular (RJ-21X) punch-down jack and runs to a modular connector (RJ-21X) on an analog trunk patch panel.

Like the telephone cabling, patch cords are connected from the analog trunk patch panel (RJ-11) to the voice switch patch panel (RJ-11).

NOTE As an alternative, patch panels can be replaced with punch-down blocks. This may be more cost-effective but is less flexible.

Rack Overview

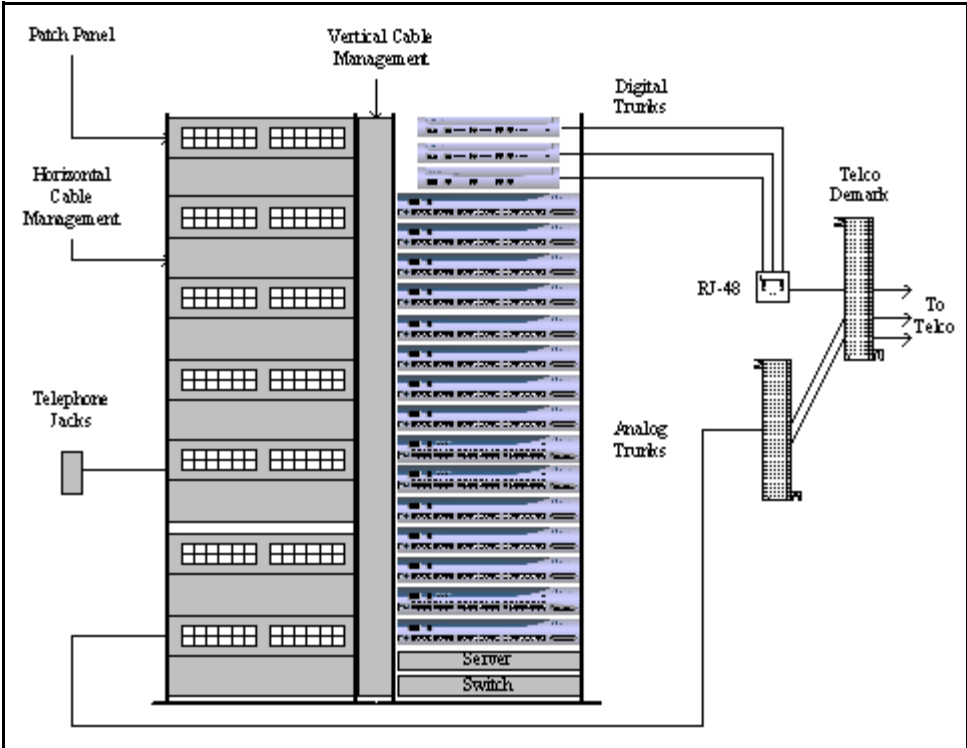

A 19-inch data rack, shelf, and modular patch panels can be purchased from most major electrical suppliers.

Connector Pinouts

ShoreGear-24 RJ-21X Telephone and Trunk Connector



Port	Designation	Pin	Cable Color
1	Tip	26	White/Blue
1	Ring	1	Blue/White
2	Tip	27	White/Orange
2	Ring	2	Orange/White
3	Tip	28	White/Green
3	Ring	3	Green/White
4	Tip	29	White/Brown
4	Ring	4	Brown/White
5	Tip	30	White/Slate
5	Ring	5	Slate/White
6	Tip	31	Red/Blue
6	Ring	6	Blue/Red
7	Tip	32	Red/Orange
7	Ring	7	Orange/Red
8	Tip	33	Red/Green
8	Ring	8	Green/Red
9	Tip	34	Red/Brown
9	Ring	9	Brown/Red
10	Tip	35	Red/Slate
10	Ring	10	Slate/Red
11	Tip	36	Black/Blue
11	Ring	11	Blue/Black
12	Tip	37	Black/Orange
12	Ring	12	Orange/Black
13	Tip	38	Black/Green
13	Ring	13	Green/Black
14	Tip	39	Black/Brown
14	Ring	14	Brown/Black
15	Tip	40	Black/Slate
15	Ring	15	Slate/Black
16	Tip	41	Yellow/Blue
16	Ring	16	Blue/Yellow

Port	Designation	Pin	Cable Color
17	Tip	42	Yellow/Orange
17	Ring	17	Orange/Yellow
18	Tip	43	Yellow/Green
18	Ring	18	Green/Yellow
19	Tip	44	Yellow/Brown
19	Ring	19	Brown/Yellow
20	Tip	45	Yellow/Slate
20	Ring	20	Slate/Yellow
21	Tip	46	Violet/Blue
21	Ring	21	Blue/Violet
22	Tip	47	Violet/Orange
22	Ring	22	Orange/Violet
23	Tip	48	Violet/Green
23	Ring	23	Green/Violet
24	Tip	49	Violet/Brown
24	Ring	24	Brown/Violet
—	Tip	50	Violet/Slate
—	Ring	25	Slate/Violet

ShoreGear-12 RJ-21X Telephone and Trunk Connector



Port	Designation	Pin	Cable Color
1	Tip	26	White/Blue
1	Ring	1	Blue/White
—	Tip	27	White/Orange
—	Ring	2	Orange/White
2	Tip	28	White/Green
2	Ring	3	Green/White
—	Tip	29	White/Brown
—	Ring	4	Brown/White
3	Tip	30	White/Slate
3	Ring	5	Slate/White
—	Tip	31	Red/Blue
—	Ring	6	Blue/Red
4	Tip	32	Red/Orange
4	Ring	7	Orange/Red
—	Tip	33	Red/Green
—	Ring	8	Green/Red
5	Tip	34	Red/Brown
5	Ring	9	Brown/Red
—	Tip	35	Red/Slate
—	Ring	10	Slate/Red
6	Tip	36	Black/Blue
6	Ring	11	Blue/Black
—	Tip	37	Black/Orange
—	Ring	12	Orange/Black
7	Tip	38	Black/Green
7	Ring	13	Green/Black
—	Tip	39	Black/Brown
—	Ring	14	Brown/Black
8	Tip	40	Black/Slate
8	Ring	15	Slate/Black
—	Tip	41	Yellow/Blue
—	Ring	16	Blue/Yellow
9	Tip	42	Yellow/Orange
9	Ring	17	Orange/Yellow

Port	Designation	Pin	Cable Color
—	Tip	43	Yellow/Green
—	Ring	18	Green/Yellow
10	Tip	44	Yellow/Brown
10	Ring	19	Brown/Yellow
—	Tip	45	Yellow/Slate
—	Ring	20	Slate/Yellow
11	Tip	46	Violet/Blue
11	Ring	21	Blue/Violet
—	Tip	47	Violet/Orange
—	Ring	22	Orange/Violet
12	Tip	48	Violet/Green
12	Ring	23	Green/Violet
—	Tip	49	Violet/Brown
—	Ring	24	Brown/Violet
—	Tip	50	Violet/Slate
—	Ring	25	Slate/Violet

RJ-11 Telephone and Trunk Connector

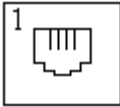

Pin	Designation
1	—
2	—
3	Tip
4	Ring
5	—
6	—

RJ-45 LAN Connector

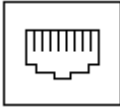

Pin	Designation
1	TX+
2	TX-
3	RX+
4	—
5	—
6	RX-
7	—
8	—

3mm Mono Audio Input and Output Connectors

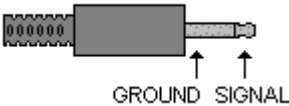

NOTE From the cable perspective.

RJ-48C T1 and T1 Monitor Connectors

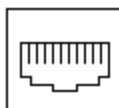

Pin	Designation
1	RX Ring
2	RX Tip
3	—
4	TX Ring
5	TX Tip
6	—
7	—
8	—

NOTE When connecting the ShoreGear-T1 to a legacy PBX, you must use a crossover cable between the two systems.

DB-9 Maintenance Connector



Pin	Designation
1	—
2	TX Data
3	RX Data
4	DSR
5	GND
6	DTR
7	CTS
8	RTS
9	—

IP Phone Configuration

ShoreTel IP phones are preconfigured by ShoreTel to work in conjunction with your ShoreTel 7.5 system and your network's Dynamic Host Configuration Protocol (DHCP) server. Once the servers are configured, you simply plug the phones into the network and they are automatically added to your ShoreTel 7.5 system.

The ShoreTel server provides the IP phones with the latest application software and the configuration information that enables the IP phone to be automatically added to the ShoreTel 7.5 system. The ShoreTel server's address must be provided to the phone as a vendor-specific option.

For information on configuring DHCP for the IP phones, see “Configuring DHCP for ShoreTel IP Phones” on page 9-20 and “DHCP Settings” on page 15-5.

However, if you are installing ShorePhone IP phones in a network without a DHCP server, you must set the IP parameters manually through the phone interface.

Manually Configuring the ShorePhone-IP100

The setup menu is accessible when the ShorePhone-IP100 phone boots. You can enter this menu during a six-second period, after which the phone enters normal operation using the current settings.

NOTE Please check the ShoreCare website for Product Bulletin ST-0201 End of Life documentation for this model.

Rebooting the ShorePhone-IP100

There are two ways to reboot the ShorePhone-IP100:

- By reapplying power
- By pressing four of the phone's keys simultaneously

The IP phone reboots whenever power is reapplied. You can accomplish this by disconnecting the power cable momentarily and then reconnecting it.

You can also reboot the ShorePhone-IP100 by pressing four keys simultaneously. The four keys (as illustrated in Figure D-1) are:

- Middle Blank Key
- Hold
- Volume –
- Volume +

Hold down these keys until the display shows that the ShorePhone-IP100 phone is rebooting.



Figure D-1 Reboot Keys on the ShorePhone-IP100

During the boot process, the phone displays an option to enter the setup menu by pressing one of the soft keys (see Figure D-2). To enter the setup menu, press the soft key below SETUP on the display.

You are prompted for a password. Enter 456 from the keypad.

After you have made your IP parameter settings, you must reboot the phone.

Navigating the Phone Menu

You can navigate the ShorePhone-IP100 phone menu interface using the IP phone keys shown in Figure D-2.



Figure D-2 Menu Keys

Table D-1 explains the functions of these keys.

Table D-1 Key Functions

Key	Description
Scroll and Select	Use these keys to scroll through menu items and options. For some options, you can use the top and bottom arrow keys to skip to the first or last parameter in a range. The left-arrow key functions as a backspace key.
Soft Keys	The function of these keys changes with the current menu. The display shows the function of the active soft keys.
Alphanumeric keys	Use these keys and the soft keys to enter numbers and letters, such as for IP addresses and name strings.

Menu Options

The ShorePhone-IP100 phone menu interface consists of the main setup menu and two submenus. The submenus set parameters for the Dynamic Host Configuration Protocol (DHCP) server and the ShoreTel server. You can scroll through menu options as described in the preceding section.

Table D-2 describes the options available from the main menu in the order in which they appear.

Table D-2 Main Menu Options

Option Name	Value	Description
DHCP Client	Enable or Disable	Set to Enable by default. To configure TCP/IP parameters, disable DHCP Client.
DHCP Menu		Settings in this menu have been optimized for the ShoreTel 7.5 system. Do not make changes to these settings.
Phone IP Address	Dotted-decimal IP address	The phone's IP address.
Subnet Mask	Dotted-decimal subnet mask	The phone's subnet mask.
IP Gateway	Dotted-decimal IP address	The phone's default router.
Server Menu		See Table D-3 for ShoreTel server options.
SNTP Address	Dotted-decimal IP address	The SNTP server from which the IP phone obtains the current time.
GMT Offset	-12 through +13	The offset from Greenwich Mean Time in half-hour increments.
DNS Server	Dotted-decimal IP address	The primary server to which the IP phone directs Domain Name System queries.
DNS Alternate Server	Dotted-decimal IP address	The secondary server to which the IP phone directs Domain Name System queries.
DNS Domain	Domain name string	The IP phone's domain.
CDP	Enable or Disable	Enable/disable Cisco Discovery Protocol.
VLAN ID	0 through 4094	The IP phone's 802.1Q VLAN identifier.

When DHCP is used to provide the IP address and configuration parameters to the telephone, the DHCP settings indicate which DHCP option is used to provide the

ShoreTel Server's address as the telephone's boot server. The settings configured in the telephones must match that of the DHCP server.

When DHCP is not used to configure the telephone's boot server as the ShoreTel server, set the options described in Table D-3 using the telephone's Server Menu.

Table D-3 Server Menu Options

Option Name	Value	Description
Server Type	FTP, Trivial FTP	When set to FTP, the IP phone uses the File Transfer Protocol (FTP) to obtain configuration and application files at boot time. To configure the phone to use the ShoreTel server as its boot server, the Server Type <i>must</i> be configured to FTP.
Server Address	Dotted-decimal IP address	This is the boot server used in any of the following situations: <ul style="list-style-type: none"> • If the DHCP client is disabled • If the DHCP server does not send a boot server address. • If the Boot Server parameter is set to Static. To configure the phone to use the ShoreTel server as its boot server, the Server Address is configured as the name or IP address of the ShoreTel server.
FTP User	Any string	When the Server Type parameter is set to FTP, this is the user name used when the IP phone logs in to the ShoreTel server. The default is <code>anonymous</code> . To configure the phone to use the ShoreTel server as its boot server, the FTP User setting <i>must</i> be configured to "ftp."
FTP Password	Any string	When the Server Type parameter is set to FTP, this is the password used when the IP phone logs in to the ShoreTel server. The default password is <code>ftp</code> . To configure the phone to use the ShoreTel server as its boot server, the FTP Password <i>must</i> be configured to "ShoreTel."

Manually Configuring the ShorePhone-IP110/115/210/212k/230/530/560/560g and BB24

If you are not using a DHCP server to provide the IP address and configuration parameters to the phone, you need to manually set configuration parameters on the phone.

You can enter the phone configuration menu at bootup or by entering a key sequence from the phone's keypad.

To manually configure the ShorePhone-IP110/115/210/212k/230/530/560/560g or BB24 at bootup:

- Step 1** Connect the Ethernet cable into the data jack on the back of the IP phone or BB24 device.
- Step 2** At the **Password** prompt, enter the default password `1234`, or the password provided by your system administrator, followed by the # key.

You have four seconds to enter the password, after which the phone enters normal operation with its current settings.

NOTE The default password can be changed in ShoreWare Director. For more information, see the *ShoreTel 7.5 Administration Guide*.

NOTE The BB24 setup screen can be accessed by pressing the upper leftmost and lower rightmost buttons.

Step 3 Enter the values listed in Table D-4 when prompted. Press # to advance to the next settings or * to exit.

Table D-4 Configuration Values

Prompt	Value
Clear All Values?	Press #. (No)
DHCP=	Press * to toggle to the “off” position and then press #.
FTP=	Enter the IP address of your ShoreWare server. Press #.
MGC=	Press #. (The phone will obtain the address from configuration files on the ShoreWare server).
SNTP=	Enter the IP address of your time server. Press #.
802.1Q Tagging=off	Press #. Consult your network administrator before changing this value.
VLAN ID=	Press #.
Country=	Enter the country code (see Table 9-12).
Language=	Enter the language code (see Table 9-13).
Save all Changes	Press #. (Yes)

The phone downloads the latest bootROM and firmware from the ShoreTel server and in the process, reboots several times. When the phone displays the date and time, the boot and upgrade process is complete.

To manually configure an operational ShorePhone-IP110/115/210/212k/230/530/560/560g from the keypad:

Step 1 With the phone on hook, press the MUTE key followed by 73887# (SETUP#).

Step 2 At the **Password** prompt, enter 1234 , or the password provided by your system administrator, followed by the # key.

NOTE The default password can be changed in ShoreWare Director. For more information, see the *ShoreTel 7.5 Administration Guide*.

Step 3 Enter the values listed in Table D-4 when prompted. Press # to advance to the next settings or * to exit.

The phone downloads the latest bootROM and firmware from the ShoreTel server and in the process, reboots several times. When the

phone displays the date and time, the boot and upgrade process is complete.

Displaying ShorePhone-IP110/115/210/212k/230/530/560/560g Settings

You can display the phone's current IP parameters setting by entering a key sequence from the phone's keypad.

To display the phone's IP parameter settings:

- Step 1** With the phone on hook, press the MUTE key followed by 4636# (INFO#). The phone will display the first two parameters.
- Step 2** Press # to advance the display or * to exit. The phone will resume normal operation after the last parameter has been displayed.

Resetting the ShorePhone-IP110/115/210/212k/230/530/560/560g

You can reset the phone by entering a key sequence from the phone's keypad.

To reset the phone:

- Step 1** With the phone on hook, press the MUTE key followed by 73738# (RESET#). The phone will reboot.

Enabling Internet Access to ShoreTel Web Access

This appendix describes how to provide Internet access to ShoreTel's Web Access client using Apache Server as a reverse proxy.

Overview

ShoreTel recommends that you enable Internet access to ShoreTel Web Access by deploying a reverse proxy based in the DMZ of your corporate firewall. You can use any of the many reverse proxy products available to implement this solution.

This appendix provides information specific to Apache Server installed on a Microsoft 2003 Server. Apache Server is an open source product and is widely used today. Additional product details and information for the Apache Server can be found on the Apache Web site.

WARNING Implementing a reverse proxy server incorrectly can compromise the security of your corporate network. Before attempting to implement a reverse proxy server, consult a network security expert with proxy and firewall experience. Open proxy servers present vulnerabilities to both the private corporate network and the public Internet.

Requirements

To complete the implementation described in this appendix you need:

- Windows Server 2003. Additional OS platforms are supported.
- Apache Version 2.x or later

Installation and Configuration

The following sample configuration is based on the Apache Server sitting in a DMZ with a legitimate Internet IP address.

To install an Apache Server as a reverse proxy:

- Step 1** Install the Apache Server. For proper installation and setup, see Apache documentation.
- Step 2** After you have installed the Apache Server, find the Apache documentation and read the Proxy Module section. The default location for the Proxy Module documentation is: `http://servername/manual/mod/mod_proxy.html`. Read the entire section before continuing.
- Step 3** Open the `httpd.conf` file (see Apache documentation for location of the `httpd.conf` file).
- Step 4** Add the lines from Example 1 or Example 2 to the end of the file.

Example 1 uses the default HTTP port 80. Example 2 uses port 5440, which is a port director that CSIS and ShoreWare Web Client monitor.

NOTE In the examples given below, replace the text “ServerName” with the machine name or IP address of the ShoreWare Director server.

- Step 5** Depending on which port you are using, either port 80 or port 5440, you must open the firewall to allow traffic from the proxy to the ShoreWare server.

Example 1:

```
#####
#Load the general proxy module and the http specific one
LoadModule proxy_module modules/mod_proxy.so
LoadModule proxy_http_module modules/mod_proxy_http.so
#####
#make sure you disable forward proxy
ProxyRequests off

#Reverse proxy to ShoreTel Web Client
ProxyPass /ShoreWareWebClient/ http://ServerName/ShoreWareWebClient/
ProxyPassReverse /ShoreWareWebClient/ http://ServerName/
ShoreWareWebclient/

# Note: This configuration will use the default HTTP port 80
```

Example 2:

```
#####
#Load the general proxy module and the http specific one
LoadModule proxy_module modules/mod_proxy.so
LoadModule proxy_http_module modules/mod_proxy_http.so
#####
#make sure you disable forward proxy
ProxyRequests off

#Reverse proxy to ShoreTel Web Client
ProxyPass /ShoreWareWebClient/ http://ServerName:5440/
ShoreWareWebClient/
ProxyPassReverse /ShoreWareWebClient/ http://ServerName:5440/
ShoreWareWebClient/
```

About the httpd.conf file

In the above examples, setting “ProxyRequests” to “off” prevents the Apache Server from functioning as a forward proxy server. This setting does not disable use of the ProxyPass directive.

In a typical reverse proxy configuration, this option should be set to “off.”

If you want the additional functionality of HTTP or FTP proxy sites, add the following lines to the configuration file:

```
mod_proxy_http <../mod/mod_proxy_http.html>
or
mod_proxy_ftp <../mod/mod_proxy_ftp.html>
```

ShoreWare Clients on Citrix and Windows Terminal Servers

This appendix describes how to configure Citrix and Windows Terminal Servers to run ShoreTel's Call Manager clients.

Overview

Windows Terminal Server (WTS) and Citrix technologies can dramatically reduce management overhead in environments where many users use the same set of applications on similar PC desktops. These technologies allow you to centralize applications and simplify application management and upgrades. Additionally, these technologies allow you to remotely assist and support users with application questions or issues.

This appendix provides information specific to running ShoreWare clients. For complete information on Windows Terminal Server or Citrix technologies, see the documentation available online at the Microsoft or Citrix Web sites.

Installing Call Manager on WTS or Citrix Platforms

Before the client version of the ShoreTel Remote TAPI Service Provider can function correctly on Windows Terminal Server or Citrix platforms, you must perform the following steps:

- Step 1** Install ShoreWare client as described in Chapter 18, "Desktop Installation."
- Step 2** Reboot if requested.

- Step 3** Go to the Windows Control Panel and open the **Phone and Modem Options>Advanced** tab as shown in Figure F-1.

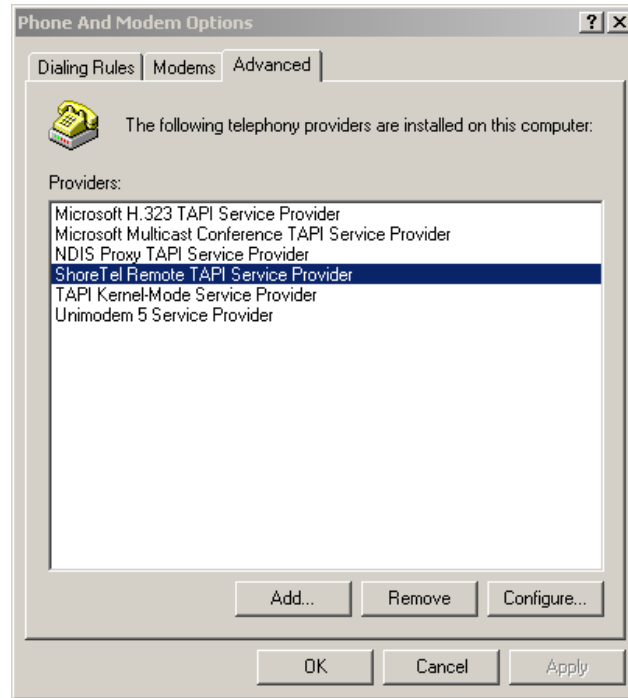

Figure F-1 Phone And Modem Options, Advanced tab

- Step 4** Remove all ShoreTel providers.
- Step 5** Copy the following file “TspInstall.exe” from the headquarters machine (**Program Files > Shoreline Communications > ShoreWare Server**) to the Citrix terminal server. We recommend copying the file to the following location:
c:\program files\Shoreline Communications\ShoreWare Client\
- Step 6** From the Citrix terminal server, launch the command prompt by clicking on the Start bar and selecting **Run** and typing **cmd**.
- Step 7** Navigate to the directory where the “TspInstall.exe” file was copied and run the TSPinstall utility as shown in Figure F-2. Make sure you substitute the correct hostname or IP address of the Headquarters instance of ShoreWare Server. The syntax of the command is:

```
TSPinstall -i StServer <HQ servername>
```

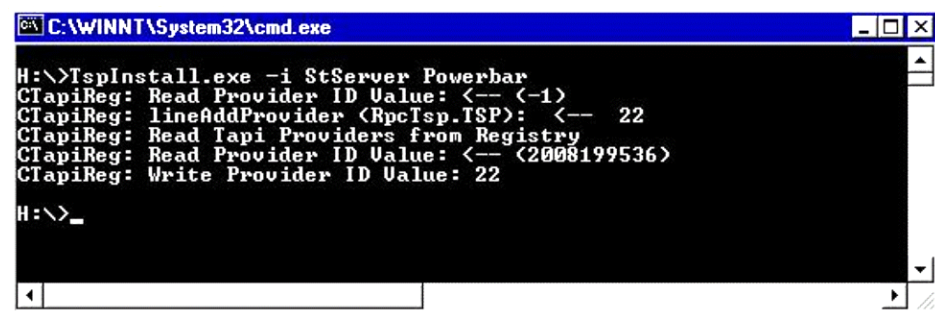

Figure F-2 TSPInstall Command Line

- Step 8** Return to the Windows Control Panel and open the **Phone and Modem Options>Advanced** tab.
- Step 9** Click on the **ShoreTel** provider and click **Configure** to display the **ShoreTel Remote TSP** dialog box, as shown in Figure F-3.
- Step 10** If the ShoreTel Remote TAPI Service Provider has a connection to the ShoreWare Server, the **ShoreTel Remote TSP** dialog box appears as shown in Figure F-3.

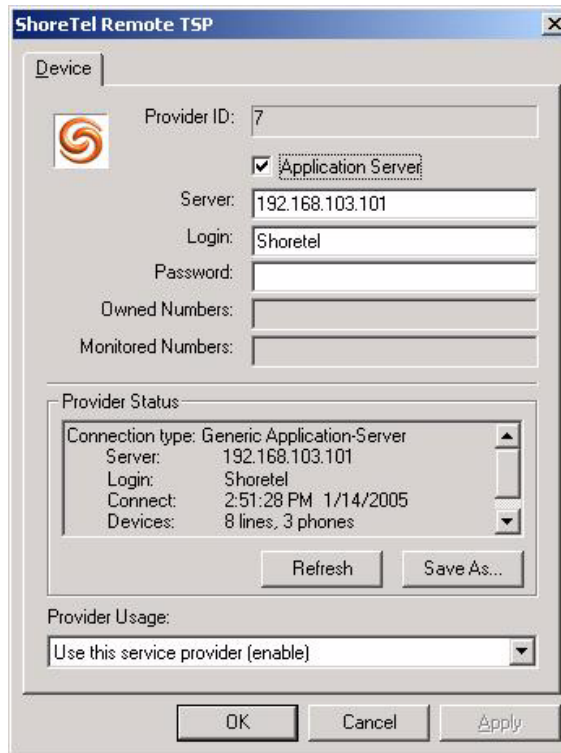

Figure F-3 Functioning Remote TSP under WTS and Citrix Example

Figure F-4 shows an error message in the **Provider Status** field and has blanks for the Server Name and Login fields. This indicates a null instance of ShoreTel Remote TAPI Service Provider, and indicates that this provider must be removed.

- Step 11** To remove the provider, go to the **Control Panel** and open **Phone and Modem Options**, and then select the **Advanced** tab. Click on **ShoreTel Remote TAPI Service Provider** and then click **Remove**, as shown in Figure F-1.

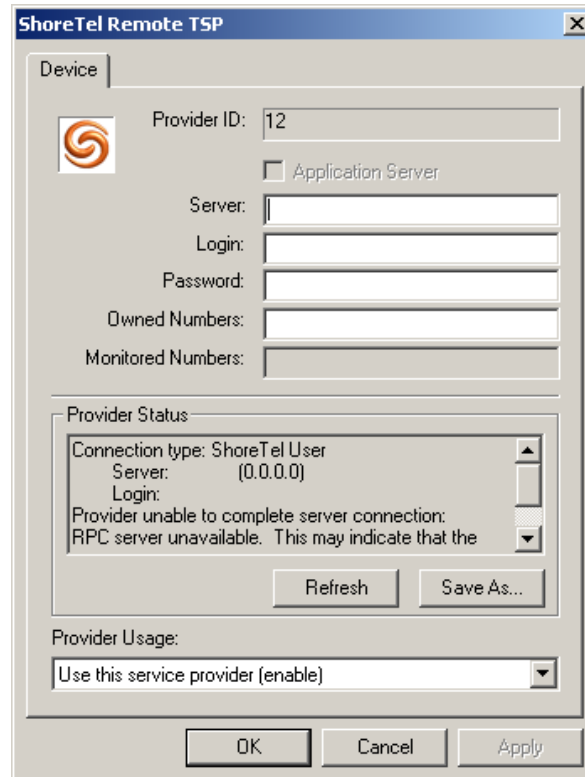

Figure F-4 Non-functioning Remote TSP for an Application Server

Citrix Application Mode

Citrix supports two application modes: Desktop and Published Application. When Citrix is running in Published Application mode, you must take the following steps on the Citrix server to run the Personal Call Manager clients.

To configure the Citrix server:

- Step 1** Run `dcomcnfg.exe` on the PC supporting the Citrix server.
- Step 2** Under applications, select `STClientLogin`.
- Step 3** Click **Properties**.
- Step 4** Click the **Identity** tab.
- Step 5** Select **The launching user**.
- Step 6** Click **OK**.

Configuring Other TAPI Applications

Unlike the Call Manager installation on a single user system, the TAPI Service Provider on a Windows Terminal Server or Citrix system provides access to all telephony endpoints. While the ShoreTel Call Manager application only accesses the telephone extension for the appropriate user, care must be taken with third-party TAPI-capable applications which may be configured to act on any telephone extension.

For example, Microsoft Outlook and the Windows Dialer can be configured to place calls on a ShoreTel extension via TAPI. Each of these applications must be configured on a per-user basis to use the correct line device for that user. Once the Windows Dialer has been configured, it will store a unique line identifier in the Windows Registry for that user so that future sessions will always use the correct telephone extension.

Session Initiation Protocol

This chapter provides detailed information about the Session Initiation Protocol (SIP). You should refer to this chapter for help in planning a SIP deployment on your ShoreTel system.

Overview

Session Initiation Protocol (SIP - RFC 3261) is a newer protocol that is still being fine tuned by the IETF and that is regarded as having the potential to become the global signaling standard that will enable all switches, gateways, and phones to talk to one another.

The protocol, which works at the application layer, allows users to initiate interactive sessions between any network devices that support the protocol. SIP is capable of initiating or terminating Internet telephony calls and other multimedia applications such as video or gaming.

The protocol is based on a client-server model. With support for redirection services, networked users can initiate a call or receive a call, regardless of their physical location.

In its networking negotiations SIP takes into account the following pieces of information:

- the address of the end system
- the physical media
- the call recipient's acceptance to the invitation

The protocol then configures the parameters for the session and handles the call setup and tear-down.

SIP allows two discrete ShoreTel systems to be integrated with any IP connection, without the need for physical tie trunking. (Note that care should be taken to make sure that the extension numbering plans in the two systems do not overlap, and that if they do overlap, translation tables need to be used to resolve conflicts.)

Further, the addition of SIP obviates the need to support other trunking standards, such as BRI, through use of a SIP gateway.

In ShoreTel 7.5, SIP is supported via SIP trunks. SIP trunks will be assigned to a particular switch as with any other trunk, so that SIP calls into and out of the ShoreTel system will be routed through these trunks. However, up to five SIP trunks can be associated with one analog switch port, meaning that there will be no physical channel/port associated with each SIP trunk. The SIP trunk is a logical trunk end point which only handles call control responsibilities. The media flows directly between the end-point SIP devices (i.e. call initiator and the call terminator), freeing the switch from the burden of controlling media flow.

WARNING We do not recommend placing Emergency 911 calls from SIP devices. ShoreTel supports SIP trunks, but does not directly support SIP extensions with this release, thus users should not place 911 calls from any device that they believe is a SIP extension.

Supported RFCs

ShoreTel 7.5 supports the following RFCs:

- 1889 - Transport Protocol for RTP Applications
- 2806 - URL for Telephone Calls
- 2327 – Session Description Protocol (SDP)
- 2396 - URI (Uniform Resource Identifiers)
- 2833 - DTMF
- 2976 - SIP Info
- 3261 - SIP (Session Initiation Protocol)
- 3361 - DHCP (for IPv4)
- 3515 - SIP Refer Method
- 3891 - SIP Replaces Header
- 3892 - SIP Referred-by Mechanism
- 3966 - URI for Telephone Calls

General SIP Comments

Conferencing

- Ports for MakeMe conferences must be available on the initiating side of a 3-way conference call involving a SIP end-point.
- MakeMe conference ports are needed even for 3-way conference. Note that configuration of any MakeMe conferencing support in Director requires a minimum of 3 available conference ports.
- An individual SIP trunk must be provisioned for each call to the SIP device (including conference-in or transferred calls). Thus, static SIP trunks must be provisioned with additional trunks in line with the highest anticipated number of such calls. Similarly, dynamic SIP trunks also require that additional individual dynamic SIP trunks are provisioned to handle calls that are placed on hold or for conference-in calls.

DTMF

- With G.729, ShoreTel both sends and receives DTMF out of band per RFC 2833.

- With G.711, ShoreTel will only receive DTMF per RFC 2833. Not all ShoreTel endpoints will send DTMF with G.711. For example, switches may not but ShoreTel IP phones will.
- ShoreTel IP phones support in-band G711 DTMF signaling. However, out-of-band DTMF is required for a SIP device to send DTMF to ShoreTel's voicemail or auto attendant. SIP INFO or DTMF per RFC 2833 can be used.
- ShoreTel can be configured to use the SIP INFO function for DTMF signaling for environments where out-of-band DTMF is needed but in which RFC 2833 is not applicable. Note that SIP tie trunks must use SIP INFO and cannot use RFC 2833 DTMF Relay.
- ShoreTel 7.5 offers support for RFC2833 (DTMF), so if the voicemail server is down, external callers can now enter an extension using DTMF to ring the extension of the user they are trying to reach. This allows callers who are accessing the ShoreTel system over a SIP trunk to have access to the Backup Auto-Attendant in the same manner as users who are accessing the system via all other trunk types.

Foreign Language Support

- In addition to English, ShoreTel will support Spanish, French and German (Caller Name, Called Name, User Name) over SIP tie trunks and service provider trunks, although certain third-party devices may not be able to display the Spanish or German characters.

Routing with Static and Dynamic Trunks

- From the trunk group perspective, when static and dynamic trunks are used:
 - only one trunk group with dynamic trunks is allowed per switch
 - outbound calls to this trunk group must be completed based in the registration table
 - calls to the same IP address will not work
 - calls to different devices going to the PSTN will be selected randomly
 - Trunk groups with static IP addresses will not route calls based on OSE ranges due to the fact that static trunks do not need registration
 - the switch sends the call to the next available trunk instead of sending it to the correct OSE within the range
 - this issue can be solved by creating a trunk group on a per-device basis
 - OSE's routed over trunk groups in more than one switch (with dynamic trunks) will fail

General Feature Limitations

- Incoming calls to an IP phone placed over a SIP tie trunk (via G729) require the IP phone user to press the “To VM” soft key twice in order to successfully transfer the caller to voice mail.
- ShoreTel 7.5 introduces support for Music On Hold (MOH) over SIP trunks. The capacity limits of MOH switches will not change (i.e. a switch will still be capable of providing up to 15 streams). However, these streams can be to other switches or to SIP devices, so customers who were not at the switch capacity limit before may now find themselves testing the limits of the switch capacity.

- If the ShoreTel server has a conference bridge 4.2 installed, you should not enable SIP. The conference bridge is not compatible with a ShoreTel system that has SIP enabled due to the dynamic RTP port required for SIP.
- 3-way conference on a SIP trunk call uses Make Me conference ports. A minimum of 3 Make Me ports must be configured to support 3-way conferencing. Make Me conferencing for 4 to 6 parties is not supported.
- A SIP trunk can be a member of a 3-party conference but cannot initiate a 3-way conference (unless the SIP device merges the media streams itself).
- ShoreTel SIP supports basic transfers (i.e. blind transfers) and attended transfers (i.e. consultative transfers).
- Silent Monitoring is not supported on a SIP trunk call.
- Barge-In is not supported on a SIP trunk call.
- Call recording is not supported on a SIP trunk call. Call recording requires presence of a physical trunk in the call.
- Call redirection by SIP devices is not supported.
- Park/Unpark is not supported on a SIP trunk call. This is planned for a future release.
- Office Anywhere is not supported on SIP trunks. Outbound trunk hunting will automatically avoid SIP trunks when placing the call to the Office Anywhere user. The call to the Office Anywhere user cannot be a SIP trunk; however, the call to the external party can be a SIP trunk.
- Silence detection on trunk-to-trunk transfers is not supported since it requires a physical trunk.
- Fax (and modem) redirection is not supported with SIP trunks as only physical trunks can detect fax tones.
- ShoreTel SIP supports two codecs - G.711 and G.729.
- G.711 SIP devices that do not support RFC 2833 DTMF cannot send DTMF digits to Voicemail (VM) or Auto-Attendants (AA).
- G.729 only SIP devices cannot talk to VM/AA unless they are configured as Teleworkers or configured in remote site.
- SIP devices cannot have a voicemail box, cannot use PCM, cannot be a member of a hunt group, cannot be a member of a workgroup, and will not appear in the dial by name directory of the AA because they are SIP trunks and not SIP extensions.

Additional Configuration Considerations

- SIP Info configuration in a Trunk Group should be enabled if ShoreTel SIP tie trunks are used.
- Overlapping number plans are not allowed between two systems tied with SIP trunks unless digit translation is used.
- When translating digits between two ShoreTel systems tied with SIP trunks, even system extensions like VM, AA should be properly translated.
- SIP devices should either be physically present in the ShoreTel site where the ShoreGear switch is hosting the SIP trunk or should be out of the ShoreTel network.
- A SIP trunk group cannot host both dynamic and static SIP trunks simultaneously.
- A SIP trunk group hosting dynamic SIP trunks cannot span ShoreGear switches.
- When ShoreTel is working with Dynamic Trunks:
 - Multiple registrations of different numbers using the same IP address is not supported as ShoreTel uses the last one received. (This is the case of Mediatrix 2102/1402; customers are expected to use only static trunks for these devices.)

- When ShoreTel is working with Static Trunks:
 - OSE ranges might not work when different SIP devices are part of the same trunk group. Customers are expected to create a dedicated trunk group for each device that needs a static trunk.
 - Customer must ensure that SIP devices work with static trunks. Routing problems may occur when the same switch has a dynamic trunk group. These devices should not be registered with the ShoreTel system.
- Director does not show information about the SIP devices registered in a switch. This information can be accessed by telnetting to the switch and issuing the command `print_register_table` (applies only to dynamic SIP trunks).
- Groups of SIP trunks can be created at once but must be deleted individually (i.e. one at a time).
- SIP devices need to work with dynamic audio ports. Customers are expected to disable the parameter that forces the system to use only audio port 5004¹.

1. Can be found in Director under Call Control > Options.

Configuration

Configuring SIP on your ShoreTel system consists of the following tasks:

- Configuring the ShoreTel System via Director
 - Reserve the Trunk
 - Create a Trunk Group
 - Create a Trunk (static or dynamic)
- Configure the SIP Device (per the manufacturer's instructions)

These tasks will be discussed in more detail below.

Configuring the ShoreTel System via Director

One of the first tasks involved in configuring your ShoreTel system for Session Initiation Protocol (SIP) is to reserve the trunk. This can be done by following the procedure below:

Reserve the SIP Trunk

To reserve a new SIP trunk, follow the procedure below:

- Step 1** Launch **ShoreWare Director** and enter the user ID and password.
- Step 2** Click on the **Administration** link to expand the list (if it has not already been expanded).
- Step 3** Click on the **Switches** link.
- Step 4** Click on the **Add new switch at site** drop-down menu and select the location for the new switch, or edit an existing switch.
- Step 5** Click on the **of type** drop-down menu and select the type of switch that will be used to support the SIP trunks.
- Step 6** Click **Go** to display a window similar to the one shown below.

Switches
Edit ShoreGear-40/8 Switch

New Copy Save Delete

Edit this record Refresh this page

Name: SIP 1

Description: San Jose (HQ_sip)

Site: Headquarters

IP Address: 192.168.20.10 Find Switches

Ethernet Address: 00-10-49-

Server to Manage Switch: SIP 1

Caller's Emergency Service Identification (CESID): (e.g. +1 (408) 331-3300)

Music On Hold Source

Ports for the new switch will be created when you click 'Save'.

Port	<input type="checkbox"/> IP Phones	<input type="checkbox"/> Conference	<input checked="" type="checkbox"/> SIP Trunks	Description	Jack Number
1	<input type="checkbox"/>	<input type="checkbox"/>	<input checked="" type="checkbox"/>		
2	<input type="checkbox"/>	<input type="checkbox"/>	<input checked="" type="checkbox"/>		
3	<input type="checkbox"/>	<input type="checkbox"/>	<input checked="" type="checkbox"/>		
4	<input type="checkbox"/>	<input type="checkbox"/>	<input checked="" type="checkbox"/>		
5	<input type="checkbox"/>	<input type="checkbox"/>	<input checked="" type="checkbox"/>		
6	<input type="checkbox"/>	<input type="checkbox"/>	<input checked="" type="checkbox"/>		
7	<input type="checkbox"/>	<input type="checkbox"/>	<input checked="" type="checkbox"/>		
8	<input type="checkbox"/>	<input type="checkbox"/>	<input checked="" type="checkbox"/>		
9	<input type="checkbox"/>	<input type="checkbox"/>	<input type="checkbox"/>		
10	<input type="checkbox"/>	<input type="checkbox"/>	<input type="checkbox"/>		

Figure G-1 Configuring switch for SIP

- Step 7** Enter a name for the switch in the **Name** field.
- Step 8** Enter a description for the switch in the **Description** field.
- Step 9** Click the **Find Switches** button next to the IP Address field and select the appropriate switch to populate the field with an IP address.
- Step 10** The Ethernet Address field auto-populates.
- Step 11** Click on the **Server to Manage** drop-down menu and select the server that will manage this switch.
- Step 12** Enter a CESID value in the **Caller's Emergency Service Identification (CESID)** field. (optional)
- Step 13** Select the **SIP Trunks** check box to the right of the port(s) that will be associated with a SIP trunk. Each port supports five SIP trunks.

NOTE The fax redirect feature will not work with calls that come in on SIP trunks.

Step 14 Click the **Save** button to store your changes.

Create a SIP Trunk Group

To create a new SIP trunk group, follow the procedure below:

- Step 1** Launch **ShoreWare Director** and enter the user ID and password.
- Step 2** Click on the **Administration** link to expand the list (if it has not already been expanded).
- Step 3** Click on the **Trunks** link to expand the list.
- Step 4** Click on the **Trunk Groups** link.
- Step 5** In the **Add new trunk group at site** drop-down menu, select the location where the new SIP trunk group will be added. In the of type drop-down menu, select **SIP**.
- Step 6** Click **Go** to display a window similar to the one shown below.

Figure G-2 Creating a SIP trunk group (inbound configurations)

- Step 7** Enter the name of the trunk group in the **Name** field.
- Step 8** Select the desired language for the trunk group in the **Language** drop-down menu.

- Step 9** Select the **Teleworker** check box if the SIP endpoint is not at the same site as the trunk group being configured. Selecting **Teleworker** has the following effects on the system behavior:
- Audio proxies via the SG vs. the RTP are directed to ShoreWare Director or DVS.
 - RTP audio packets are sent in 20 ms audio samplings instead of 10 ms.
 - The inter-site call codec is used.

- Step 10** Select the **Enable SIP Info for G.711 DTMF Signaling** check box to have SIP information sent between the SIP device and voice mail. Enable this if connecting two ShoreTel systems with SIP tie trunks. Clear if the trunk is primarily used to connect a third-party SIP device.

- Step 11** Select the **Enable Digest Authentication** check box and enter a user ID and password for enhanced security. All third-party SIP devices will be required to have matching information in the associated fields, and the user ID and password of the device will be authenticated against the information stored in the ShoreTel system. (optional)

NOTE If checked, any third-party SIP devices that you would like to have access the ShoreTel system must be configured with the same user ID and password information that you have entered here.

- Step 12** Enter the desired number in the **Number of Digits from CO** field.

- Step 13** Select the **DNIS** check box and click the **Edit DNIS Map** button to add entries to the DNIS Map.

- Step 14** Select the **DID** check box and click the **Edit DID Range** button to add entries to the DID Digit Map.

- Step 15** Select the **Extension** check box to route calls directly to the extension based on the number of digits received from the SIP device, and select the appropriate radio button.

- **Translation Table** - Select this option to use a digit translation table to ensure that inbound calls are the proper length.
- **Prepend Dial in Prefix** - Select this to prepend inbound calls with a number that you can specify in the field.
- **Use Site Extension Prefix** - Select this to use the extension prefix associated with the site.

- Step 16** Select the **Tandem Trunking** check box allow a legacy voice system to use a ShoreTel system for outbound dialing.

- **User Group** - Tandem calls are associated with a user group for outbound trunk selection. In-bound calls that are recognized as tandem calls are then redirected to an outbound trunk based on the call permissions and trunk group access associated with the user group set in Director.

- Dial in Prefix - When needed, you can specify a “dial in prefix” which is prepended to digits collected on tandem calls. The concatenated set of digits is then be used in outbound trunk selection for the tandem call.

Step 17 Click **Save** to store your changes.

To configure the outbound options for this trunk group:

Step 18 Continue scrolling down to display a window similar to the one below:

Outbound:

Network Call Routing:

Access Code:

Local Area Code:

Additional Local Area Codes:

Nearby Area Codes:

Trunk Services:

Local

Long Distance

International

n11 (e.g. 411, 611, except 911 which is specified below)

911

Easy Recognizable Codes (ERC) (e.g. 800, 888, 900)

Explicit Carrier Selection (e.g. 1010xxx)

Operator Assisted (e.g. 0+)

Caller ID not blocked by default

Trunk Digit Manipulation:

Remove leading 1 from 1+10D
Hint: Required for some long distance service providers.

Remove leading 1 for Local Area Codes (for all prefixes unless a specific local prefix list is provided below)
Hint: Required for some local service providers with overlay area codes.

Dial 7 digits for Local Area Code (for all prefixes unless a specific local prefix list is provided below)
Hint: Local prefixes required for some local service providers with mixed 7D and 1+10D in the same home area.

Local Prefixes: [Go to Local Prefixes List](#)

Prepend Dial Out Prefix:

Off System Extensions:

Translation Table:

Figure G-3 Creating a SIP trunk group (outbound configurations)

Step 19 Enter the appropriate trunk access code for this trunk group in the **Access Code** field. This is typically “9” in the U.S. and Canada.

Step 20 Enter the local area code for this trunk group in the **Local Area Code** field.

Step 21 Select the **Local** check box to enable local calls.

Step 22 Select the **Long Distance** check box to enable long-distance calls.

Step 23 Select the **International** check box to enable international calls.

Step 24 Select the **n11** check box to enable telephone service calls, such as directory assistance (e.g., 411 or 611, but not 911, which is specified below.)

Step 25 Select the **911** check box to enable emergency 911 calls.

NOTE You must have at least one trunk group per site that allows 911 calls.

Step 26 Select the **Easy Recognizable Codes (ERC)** check box to enable services such as toll-free dialing calls (e.g., 800, 888, 900).

Step 27 Select the **Explicit Carrier Selection** check box to enable dialing special numbers that let the caller select a long-distance carrier (e.g., 1010xxx).

Step 28 Select the **Operator Assisted** check box to enable the trunk group to dial the operator (e.g., 0+).

Step 29 Select the **Called ID not blocked by default** check box to pass Caller ID information by default on outbound calls. Note that in the United States, the user can override this option with Vertical Service Codes.

Step 30 Click the **Remove leading 1 from 1+10D** check box to drop the leading “1” if your long-distance service provider requires dialing only ten digits.

Step 31 Click the **Remove leading 1 for Local Area Codes** check box to drop the leading “1” for the local area codes (Local and Additional Local) if your local service provider requires dialing only ten digits for local area codes (particularly with overlay area codes).

Step 32 (For all prefixes unless a specific local prefix list is provided below)- Click the **Dial 7 digits for Local Area Code** check box to enable the trunk to dial local numbers in the local area code with seven digits, if required by your local service providers.

Step 33 Click on the **Local Prefixes** drop-down menu and select the local prefix for your site, or click the **Go to Local Prefixes List** link to view, add, and edit the local prefixes for your sites. When you are using a local prefix list, all prefixes not listed are considered “long distance” and calls to these numbers require a long distance trunk service.

Step 34 Enter a prefix in the **Prepend Dial Out Prefix** field to have this prefix prepended to the dial-out string resulting from the other rules. A dial-out prefix is typically required when connecting to, and leveraging the trunks on, a legacy PBX. Note that the Dial Out Prefix is not applied to Off-System Extension calls.

Step 35 For **Off System Extensions**, click **Edit** to add or edit any ranges of extensions that can be accessed through this trunk group. This is typically used when setting up a tie trunk to a legacy PBX and configuring coordinated extension dialing. The Dial Out Prefix rules are not applied to Off-System Extensions.

Create a SIP Trunk

To create a new SIP trunk, follow the procedure below:

- Step 1** Launch **ShoreWare Director** and enter the user ID and password.
- Step 2** Click on the **Administration** link to expand the list (if it has not already been expanded).
- Step 3** Click on the **Trunks** link to expand the list (if it has not already been expanded).
- Step 4** Click on the **Individual Trunks** link.
- Step 5** In the **Add new trunk at site** drop-down menu, select the location where the new SIP trunk will be added. In the **in trunk group** drop-down menu, select the name of the trunk group that you created in the previous task above.
- Step 6** Click **Go** to display a window similar to the one shown below.

The screenshot shows the 'Trunks' configuration interface. At the top, there are buttons for 'New', 'Copy', 'Save', 'Delete', and 'Reset'. Below these is a navigation bar with 'Edit this record' (highlighted) and 'Refresh this page'. The main form contains the following fields:

- Site:** Headquarters
- Trunk Group:** SIP Trunk Group
- Name:** SIP trunk 1
- Switch:** SIP 1
- SIP Trunk Type:**
 - Dynamic
 - Use IP Address
- Number of Trunks (1 - 120):** 1

Figure G-4 Creating a SIP trunk

- Step 7** Enter a name for the trunk in the **Name** field.
- Step 8** Click on the **Switch** drop-down menu and select the switch that the new trunk will be associated with.
- Step 9** Select the desired SIP Trunk Type radio button. There are two choices:
 - **Dynamic** - Select this radio button to provide more flexibility than a static IP address. Note that all inbound calls will be accepted, regardless of their IP address. If this is selected, you should use the authentication methods available to prevent unauthorized callers from accessing the system.

- Use IP Address - Select this radio button to enter a static IP address. This is recommended if the systems are static and will not be changing IP addresses often.

Step 10 Enter the desired number of SIP trunks in the **Number of Trunks** field.

Step 11 Click the **Save** button to store your changes.

Configure the SIP Device

SIP devices are the third-party telephones, gateways, terminal adapters, and other devices that support the protocol. The ShoreTel phones do not currently support the SIP protocol.

With each of the SIP devices you will be using, you will have to consult the manufacturer's instructions for specific instructions on configuring the device.

In a general sense, the configurations for each SIP device will be essentially the same, and will require that the following pieces of information are entered:

- IP address of the SIP server
- IP address of the SIP registrar server
- User name (identification for outbound calls)
- User information (OSE or DID)
- User password
- DTMF protocol (i.e. must support RFC 2833)

Glossary

Administrator The office manager or IS professional responsible for installing and configuring the system.

All Trunks Busy The situation in which a user tries to make an outside call through a telephone system and receives a “fast” busy signal (twice as many as normal in the same amount of time), indicating that no trunks are available to handle the call.

API Application programming interface; software that an application program uses to request and carry out lower-level services performed by the computer's or telephone system's operating system. For Windows, the API also helps applications manage windows, menus, icons, and other graphical user interface elements.

Automated Attendant A device that answers callers with a recording and allows callers to route themselves to an extension; also called an auto-attendant.

BOOTP Boot Protocol, a standard protocol for assigning networking information to client workstations over the network; similar to but less sophisticated than DHCP.

Call Control The dynamic, transactional servicing of calls, usually via a graphical user interface with call information. For example, an attendant can use a GUI application to transfer calls based on CallerID information.

Call Handling The predetermined, preconfigured features for servicing incoming calls in order to obtain certain expected results. Examples of call handling features include call forwarding on busy, call forwarding on no answer, and do not disturb.

Call Handling Mode A set of telephony and call handling features that are enabled depending on the business conditions of the user (for example, in the office or out of the office). Call handling modes, which are enabled manually by the user, include features such as call forwarding on busy, call forwarding on no answer, and the selection of the voice mail greeting to use for a particular mode.

Call History The visual records in ShoreWare Desktop, documenting all incoming and outgoing calls to the user's extension.

Call Notification A set of features that inform the user of the arrival of a new call, such as ringing the telephone or playing a sound on the workstation speakers.

Call Routing A methodology of delivering calls to destinations based on a situation or system status. Call routing can also refer to the automatic delivery of an incoming call to a particular extension, such as in DID or dedicated CO lines.

Call Stack The list of calls in ShoreWare Desktop associated with an extension, including active calls and calls that have been put on hold or are being managed in some other way by the user.

Call Waiting Usually for single-line telephones, a feature that lets a second call arrive to the line by delivering a call-waiting tone to the user and a ring-back to the caller.

Call-Waiting Tone The tone that is presented to a user with call waiting when a second call arrives.

Caller For documentation purposes, an outside caller—a person calling the telephone system from outside. See also **End User**.

CallerID A technique for transmitting the calling party's telephone number and (optionally) name to equipment enabled to handle this feature; also called CLI in Europe.

Centrex A name for advanced telephone services provided by the local telephone company. It usually requires a connection to a special telephone system but provides services such as voice mail and call forwarding.

CLASS Custom Local Area Signalling Services, a family of telephone services offered from local telephone companies, usually for a monthly fee; includes features such as CallerID, Call Waiting, call return, repeat dialing, call rejection, call trace, priority ringing, and selective call forwarding.

Class of Service Abbreviated as CoS or COS; a set of features and privileges associated with a particular user or extension, used for grouping similar users together.

CO Central Office; the building where the telephone company's telephone switching equipment that services the local area is located.

CO Line See **Trunk**.

Conference Three or more parties joined together in a single call, such that each party can hear and be heard by the others.

DHCP Dynamic Host Configuration Protocol, a protocol for downloading network information (such as IP addresses) to client workstations.

DID Direct Inward Dial, a signaling mechanism used by telephone companies to indicate to a customer's PBX what telephone number was dialed by the calling party. It can be used with analog lines but is used mostly with digital (that is, T-1) connections.

DTMF Dual-Tone Multi-Frequency, a technique of providing two tones for each button on a telephone to signal dialing digits; also known as Touch Tone.

End User For documentation purposes, a person using the telephone system from the inside, such as from an extension or a call control application, as opposed to a caller who dials in from outside the system; often shortened to "user." See also **Caller**.

Erlang Formula A mathematical way of predicting a randomly arriving workload (such as telephone calls) based on known information (such as average call duration). Although traditionally used in telephone traffic engineering to determine the required number of trunks, Erlang formulas have applications in call center staffing as well.

External Call A telephone call directed to or from outside the telephone system, and over the Public Switched Telephone Network (PSTN).

FSK Frequency Shift Key, a modulation technique used with low-speed modems; also used with CallerID and message-waiting lamp indicators.

FXO Foreign Exchange Office. An FXO interface connects to the public switched telephone network (PSTN) central office and is the interface offered on a standard telephone. An FXO interface is used for trunks, tie lines, or connections to a PSTN CO or PBX that does not support E&M signaling (when local telecommunications authority permits).

FXS Foreign Exchange Station. An FXS interface supplies ring, voltage and dial tone for basic telephone equipment, keysets, and PBXs. The FXO interface is useful for off-premises station applications.

Greeting The voice recording sent to the caller when a call is answered by voice mail or by the auto-attendant; usually a single file, and not the concatenation of smaller phrases.

GUI In ShoreTel documentation, the graphical user interface presented to the user as part of the software application that runs on the user's workstation.

Handled Call A call answered by an employee or a device, such as an auto-attendant or voice mail, as opposed to being blocked or abandoned.

Hang Up The act of putting the telephone receiver back on the hook to indicate to the telephone system that the user is done with the call.

Hold As in "on hold"; the situation in which a caller is placed in the user's call management stack for later handling.

Internal Call A telephone call dialed between internal extensions.

Java The platform-independent programming language developed by Sun Microsystems for providing complete programs, including animated graphics.

Line See **Trunk**.

Loop Start One of the mechanisms used to signal the telephone system that the calling party wants to make a call. Loop start is a completion of the circuit using a set load between the two wires (tip and ring).

Message Notification A set of features that inform the user that a new message has arrived in his or her voice mailbox, such as lighting the call-waiting lamp, paging the user, or dialing a telephone number.

Music-on-Hold (MOH) Background music heard when callers are put on hold, letting them know they are still connected. Most telephone systems have the ability to connect to any sound-producing device—for example, a radio, a cassette, or a CD player.

On Hook/Off Hook The state of the telephone as being either on the hook (hung up) or off the hook and seizing the line.

Operator The person who monitors the telephone system and transfers calls to the appropriate extensions.

Outside Caller See *Caller*.

PBX Private Branch Exchange; a term used by telephone companies to indicate equipment that is located on the customer's premises and that can route telephone calls.

Permissions Privileges granted to each user with respect to what data, features, menus, or calling options may be used. Permissions are under the control of the system administrator.

Physical Extension A common internal extension with an assigned physical port and telephone.

Prompt For an auto-attendant menu, the result of playing (concatenating) a series of phrases together.

PSTN Public Switched Telephone Network; another name for the public telephone network.

Remote Caller See *Caller*.

Ringback Tone The audible signal given to the caller by the telephone company (or telephone system) to indicate that the remote telephone is ringing.

RJ-11 Registered Jack number 11; one of the series of registered jacks and cabling developed originally by AT&T to standardize the cabling between the telephone and the telephone company lines.

Service Provider Interface (SPI) An interface between the operating system and the telephone hardware.

Status Bar A text and mini-graphics area, usually at the bottom of a software application window, that is normally used for showing the status of the application or other pertinent information.

Stutter Tone An intermittent dial tone provided by the telephone system (as opposed to the usual constant dial tone); sometimes used to indicate to the user that there are messages in his or her voice mailbox or that a feature (such as call forwarding) is enabled.

T-1 A digital transmission link with a capacity of 1.554 Mbps (1,544,000 bits per second). A T-1 trunk can normally handle 24 voice conversations, each digitized at 64 Kbps. T-1 lines are used for connecting networks across remote distances.

Telco An abbreviation for telephone company.

Telephony Application Programming Interface (TAPI) A telephony software interface included in Microsoft Windows 95, 98, and NT; the operating system that lets applications incorporate telephony control.

Tip and Ring Telephony jargon for the two wires from the telephone system to the telephone set; also indicates polarity.

Trunk Sometimes used synonymously with line or CO line. Traditionally, a trunk from the telephone company connects to a PBX only, and not to a telephone, whereas a line from the telephone company connects to a telephone. For documentation purposes,

either term can be used when referring to voice connections from the telephone company.

Trunk Hunt Group A term sometimes used to indicate a group of telephone lines configured by the telephone company to rotate incoming calls among all the lines in search of the next available one. In this way, a company can give out one main number, and all calls to that number will hunt for the next available line or trunk.

TUI Telephone User Interface; a set of defined keystrokes on the telephone keypad that are used to execute commands to either the telephony switch, voice mail, or the automated attendant.

Workstation A personal computer (PC) or similar computer.

Symbols

"Use Flash to Route Calls" check box 14-16
#22AWG wire 13-8, C-6

Numerics

10 Base-T 13-8
100 Base-T 13-8
10-digit local dialing 6-5
110 VAC modular power cord 13-8, C-5
16-bit DOS addressing 17-16
19-inch data rack 13-20
26 AWG wire, to avoid risk of fire B-4
28.8 Kbps 8-4
3.5 mm mini-mono audio output connector C-6
3mm audio input connectors C-18
3mm mono audio output connector for paging/
nightbell 13-37
3mm stereo connector, MOH 13-37
47 kW nominal impedance C-6
900 calls 7-2
911
 calls, planning 4-13
 dialing 6-7
 dialing plan considerations 6-3
 emergency calls, exception 6-3

A

AC

 power source 16-4
 surge protector 16-3, 16-4
accessing voice mail, training topics covered 20-4
account code 11-2
 collection service 11-2
 configurable extensions 7-3
 enabling 7-3
 errors 7-3
 examining outbound calls 7-4
address resolution, avoiding dependency on 17-
13
administrative assistants, training 20-2
admission control bandwidth, and WANs 9-33
Admission Control Bandwidth, calculating 9-33

admission control, defining 7-5
admission control, two ways to set 9-36
Adobe Acrobat Reader, installing 10-5
ADSL, and WANs 9-18
advantages of VoIP 9-2
after-hours call routing 4-3, 4-7, 4-9, 4-11
algorithm, network call routing 7-5
allocation, blocks of numbers 6-2
alphanumeric keys D-3
American Society of Composers 13-9
American Society of Composers, Authors, and
Publishers C-6
AMI
 line code button 16-7
AMIS
 protocol support 11-5
 protocol support and voice mail 14-6
 protocol Version 1 14-6
 send outbound voice mail 14-7
 simplification 14-7
analog connection speeds, modems 8-4
analog DID trunks 5-4
analog phone requirements 8-5
analog service 5-13
Analog Telephone and Trunk Cabling 13-8
analog telephone cabling C-5
analog trunk port setup 14-12
analog trunk ports 8-4
analog wink-start trunks 4-9, 5-4
ANI 5-8
anti-virus software, disabling before software in-
stall 17-10
AP-100 8-4
Apache Server E-1
Apache Server, installing and configuring E-2
applet 18-8
area code, configuring for a user 18-8
area codes, local 6-5
ATM 9-9
Attach Voice Mail to Message when Moved 18-12
Audio Input (Music on Hold) Cabling 13-9
audio output 13-9
Audio Output (Paging and Night Bell) Cabling

- 13-9
 - Audio tab 18-11
 - Australia, countries supported A-1
 - authentication 9-25
 - Auto-Attendant Call Routing 4-3
 - auto-attendants, multiple 9-2
 - Automated Attendant 11-18
 - Automated Call Distributor (ADC) calls 14-4
 - Automatic Call Handling, installing 18-14
 - Automatic Number Identification 4-9
 - Automatic Number Identification (ANI) 5-8
 - auto-run 17-10
 - availability C-4
 - Avaya PBX 14-28
 - avoiding exposure to rain or moisture B-4
- B**
- B8ZS 16-7
 - backing up system C-3
 - bandwidth
 - WAN 9-9
 - bandwidth calculations 9-25
 - bandwidth management 9-12
 - client bandwidth 9-13
 - distributed call control signaling 9-14
 - LANs 9-12
 - virtual LANs 9-13
 - WANs 9-13
 - bandwidth requirements for network 9-3
 - Belgium A-1
 - BOOTP C-7
 - BOOTP server 9-18, 9-19
 - bootROM 9-22
 - bootROM, downloading for phone D-5
 - bottlenecks, and traffic shaping 9-14
 - Brazil, countries supported A-1
 - broadband DSL connectivity, and VPNs 9-24
 - bytes per packet 9-8
- C**
- cable management C-12
 - cable modems 9-18
 - cabling
 - analog telephone C-5
 - Ethernet C-5
 - IP phone C-5
 - maintenance C-7
 - MOH C-6
 - power C-5
 - trunk C-5
 - trunk monitor C-6
 - cabling contractor 13-2
 - cabling installation 13-2
 - cabling requirements 1-4
 - cabling, general overview 13-19
 - cabling, planning C-1
 - call centers 3-6
 - Call Detail Records, and disk usage 10-4
 - Call Flow Analysis 1-3
 - Call Flow Design 4-1
 - Call Handling Delegation 11-18
 - call handling mode for Busy/No Answer 11-14
 - call handling modes, training topics covered 20-4
 - Call Manager 11-26
 - support by country A-3
 - Call Manager clients, and terminal servers F-1
 - Call Manager icon 18-18
 - Call Manager installation, differences with TAPI F-5
 - Call Manager software, installing 18-4
 - Call Manager, starting 18-9
 - call permissions 11-2
 - all 7-2
 - all calls 7-2
 - commas or semicolons 7-3
 - internal only 7-2
 - wild cards 7-3
 - Call permissions parameters
 - International Long Distance 7-2
 - Local Only 7-2
 - National Long Distance 7-2
 - call permissions, restrictions 7-3
 - call routing
 - after hours 4-3, 4-7
 - auto attendant 4-3, 4-5
 - blended 4-11
 - DID 4-9
 - operator 4-7
 - call routing and call distribution, training topics covered 20-4
 - call sender 11-7
 - call volume estimates 14-4
 - caller ID
 - name 5-8
 - number 5-7
 - outbound 5-10
 - caller ID information
 - collecting 4-3
 - caller ID number, international support for 8-5
 - Canada, countries supported A-1
 - canonical format, converting to 6-5
 - canonical format, external numbers 6-4

- Carrier Select numbers 7-2
- Category 5 cabling 13-8
- ccount code collection service
 - call detail reports 7-3
- ccount codes
 - states 7-3
- CD player 13-9
- CDP D-3
- centralized applications F-1
- Centrex lines 5-3
- Channel Service Unit (CSU) 13-9
- checklist, for trunking cut-over 19-3
- checklist, installation 1-3
- Citrix 10-5, F-1
- Citrix application mode F-5
- Citrix servers 3-3
- Citrix terminal server 12-3
 - installing F-2
- CLASS message waiting 8-7
- client bandwidth 9-13
- client software install procedure 18-2
- client, software installation 18-1
- coice mail integration 14-6
- Collaborative Data Objects 18-14
- COM port
 - baud rate 14-11
 - configuring 14-11
 - flow control 14-11
- COM port setup, SMDI 14-11
- command center, setting up for cut-over 19-3
- communication convergence 20-1
- communications, encrypting 9-29
- components, system 9-2
- Conference Bridge
 - ordering 1-3
- conference bridge, dialing 11-31
- conference rooms, planning for 8-3
- conferencing calls, training topics covered 20-4
- configuration switches, assigning 15-3
- configuring
 - SMDI parameters 14-21
 - SoftPhone 18-9
- Configuring Automatic VLAN Assignment via DHCP 9-22
- Configuring DHCP for IP phones 9-20
- configuring external numbers 6-4
- configuring internal numbers 6-2
- configuring local area codes 6-5
- configuring mixed dialing in the same area 6-6
- configuring networking parameters 9-19
- configuring ShoreTel Voice Mail integration us-
 - ing SMDI 14-19
 - configuring the serial connection 14-26
 - configuring the ShoreTel server for SMDI 14-21
 - configuring voice switches for IP phone 15-2
 - connectivity between locations 9-17
 - connector pinouts 13-21, C-14
 - Connectors 13-7
 - connectors C-4
 - consolidated long distance 14-6
 - Contact Center 11-33
 - Control Panel 17-16
 - ControlPoint, ShoreCare 1-3
 - conversation, and latency 9-10
 - coordinated dialing 14-2
 - coordinated dialing plan 14-4
 - copyright laws C-6
 - copyright laws, US 13-9
 - cost-effective phones 8-3
 - countries supported
 - Australia A-1
 - Brazil A-1
 - Canada A-1
 - France A-1
 - Germany A-1
 - Malaysia A-1
 - Netherlands A-1
 - New Zealand A-1
 - Singapore A-1
 - Spain A-1
 - UK A-1
 - country codes 9-21
 - courses, ShoreCare QuickStart 20-1
 - CPU, and media encryption 9-29
 - creating a trunk goup, SMDI 14-19
 - creating a user group 14-23
 - creating trunks 14-20
 - CSIS E-2
 - customers, training for Workgroup Call Manager 20-4
 - Cut 19-3
 - Cut-Over 1-7
 - cut-over after installation 1-3
 - Cut-Over Checklist 19-3
 - Cut-Over Coverage 19-4
 - cut-over coverage
 - monitoring personnel 19-2
 - scheduling on-site team 19-2
 - Cut-Over Implementation 19-2
 - Cut-Over Requirements 19-2
 - Cut-Over Worksheet 19-2
 - cut-over, to ShoreTel 19-1

D

- data files, location 17-6
- data network, integrating with 9-2
- Data-entry fields
 - conventions Preface-xv
- DB-9 female connector 13-15
- DB-9 maintenance connector 13-39
- DB-9 maintenance connectors C-19
- default trunk access code 6-8
- defining 10-digit dialing 6-6
- defining admission control 7-5
- defining trunk services 7-5
- delay 9-10
- delay in the PSTN 9-10
- Delete Voice Mail from Message when Moved 18-12
- demilitarized zone 9-27
- denial-of-service attacks 9-28
- deployment team
 - Cabling Contractor 1-2
 - Electrical Contractor 1-2
 - IT Manager 1-2
 - project manager 1-2
 - Service Providers 1-2
 - ShoreTel 1-3
 - System Designer 1-2
- desktop requirements 1-4, 12-1
- determining the number of trunks 3-5
- DHCP C-7
 - automatic VLAN assignment 9-22
 - option 155 9-20
 - option 156 9-20
- DHCP configuration for IP phones 9-20
- DHCP configuration menu D-3
- DHCP on the ShoreWare Server 10-5
- DHCP server 9-19
- DHCP server, and IP phones 15-5
- DHCP server, IP address assignment 9-18
- DHCP vendor option 155 15-2
- Dialed Number Identification Service (DNIS) 5-9
- dialing 911 6-3
- dialing configuration, planning 6-2
- dialing coordinated 14-2
- dialing parameters, TAPI 18-8
- Dialing Plan 6-1
- dialing plan
 - considerations for international deployment A-14
- dialing plan, coordinated 14-1, 14-4
- dialing rules, for a user 18-8
- Dial-Up Modems, and WANs 9-18
- DID 5-9
- DID numbers A-15
- Digit collection 6-1
- digit collection 7-1
- digit collection rules 6-3
- digit collection, defining 6-2
- digit collection, defining for internal numbers 6-3
- digit collection, ending 6-7
- Digit manipulation 6-1
- digit manipulation 6-10, 7-1
- Digit Manipulation Options 6-10
- digit manipulation, defining 6-10
- digit translation 14-14
- digit translation table, creating 14-15
- digit translation, functionality 14-15
- Digital Loop-Start Trunks 5-4
- digital trunk tie line integration 14-2
- digital trunks 7-5
- Digital Wink-Start Trunks 5-4
- Direct Inward Dial (DID) 5-9
- Direct Inward Dial call routing 4-9
- Direct Inward Dial trunks 4-9
- Disk Caching, enabling 18-15
- dissipate power and heat C-3
- Distributed Call Control Signaling 9-14
- distributed server maintenance page, accessing 10-6
- distributed server, software upgrade 17-15
- distributed server, software installation 17-10
- Distributed ShoreWare Servers 3-2
- distributed voice mail 11-4
- DMZ E-1
- DNIS 5-9
- DNS domain D-3
- DNS server D-3
- dsktop installation 18-1
- DTMF signaling 8-7
- DVD drive 17-5
- Dynamic Host Configuration Protocol server
 - DHCP server D-1

E

- E1 PRI service 5-15
- E1 PRI trunks 5-6
- echo cancellation 9-14
- echo canceller 8-3
- echo packets 9-28
- e-commerce, and security 9-27
- Editing switch configurations ??-16-7
- electrical storm, postponing installation B-4
- electrical surges 16-4

electricity, safety with B-4
 email, for notifying users 18-2
 emergency 911 calls, exceptions 6-3
 emergency calls, planning 4-13
 emergency numbers A-14
 enabling fax redirect for a user 11-16
 encryption 9-25, 9-26

- enabling during a call 9-29
- no support with SoftSwitch 9-29

 end digit collection 6-7
 End Point Name 18-10
 End User License Agreement 18-6
 end-to-end IP network, creating 8-4
 End-User Training 20-2
 engineering an IP network 9-3
 enterprise telephony features 11-28
 enterprise-wide coordinated dialing plan 14-1
 Environmental and Infrastructure Analysis 1-4
 Environmental Requirements, ShoreGear voice switch 13-6
 environmental specifications 13-6
 equipment room, ventilation requirements C-3
 ESF 16-7
 estimating call volume 14-4
 Ethernet

- framing 9-8

 Ethernet Cabling 13-8
 Ethernet cabling C-5
 Ethernet LAN connections, redundant 13-2
 Ethernet network 9-3
 explicit carrier selection dialing 6-7
 Extension and mailbox license 18-16
 extension length 14-4
 extension lengths 6-2, 6-3
 Extension-only license 18-16
 external numbers, configuring 6-4

F

fan C-4
 fault tolerance, two levels 13-8
 fax and modem calls, zero packet loss 9-11
 fax handling, planning 11-8
 fax machines 8-3

- Hewlett-Packard 8-4
- IP network quality 8-3

 fax redirect, enabling 11-16
 fax server integration 11-10
 fax server integration, configuring 11-11
 Fax Server Requirements 11-10
 fax server, using 11-9
 Find Me call handling 11-6

Find Switch dialog box 16-5
 Find Switches 16-5
 firewall E-1
 firewalls 9-27
 firewalls, and corporate networks 9-27
 firewalls, and VoIP traffic 9-28
 firmware, phone download D-5
 flash button 8-7
 forward proxy server E-3
 four seconds

- password entry D-5

 fragmentation on hard disk 17-16
 frame relay 9-9
 frame relay, and WANs 9-17
 France, countries supported A-1
 France, supported features 8-5
 front-end web servers 9-27
 FTP user D-4
 FtpServers 9-23

G

G.711 8-3, 9-4
 G.729a 9-4
 G.729a voice encoding 9-33, 9-35
 gateways 9-27
 geographic region, dialing plan 6-4
 German language license 18-16
 Germany, countries supported A-1
 Germany, supported features 8-6
 global voice network A-14
 GMT Offset 15-5
 GMT offset D-3
 GMT time 15-5
 going live with the system 1-3

H

hard disk space utilization 10-3
 hardware requirements 10-2, 12-2
 headquarters server, upgrading software 17-9
 headset connector 13-40
 headsets for

- agents 8-2
- operators 8-2
- supervisors 8-2

 headsets, for workgroup agents and supervisors 8-2
 heartbeat interval 15-2
 heat dissipation C-4
 Hewlett-Packard fax machines 8-4
 hexadecimal format, time offset 15-6
 high voltage components B-4

- higher-density trunking 3-6
- hold button, MOH 8-7
- hostname, HQ server F-2
- HTTP port 80 E-2
- httpd.conf file E-3
- humidity, operating 16-7, C-4
- Hunt Group
 - Applications 11-21
 - as a Call Forward Destination 11-21
 - busy state 11-20
 - common line monitoring 11-22
 - configurable hunting 11-21
 - distribution of calls to backup operators 11-21
- Hunt Groups 4-2, 11-20
- hunt groups, call routing 4-7
- Hypertext links
 - conventions Preface-xv
- I**
- ICMP flood attacks 9-28
- IDSL, and WANs 9-18
- illegal traffic 9-27
- implementing cut-over 19-2
- important safety instructions B-3
- importing Outlook contacts to Quick Dial 18-14
- inbound and outbound services, consolidation 14-2
- Input Power, ShoreGear voice switch 13-4
- input voltage C-3
- Installation
 - Assembling the Team 1-2
 - Communication 1-2
 - Delegation 1-2
 - Resource planning 1-2
 - Schedule planning 1-2
- installation
 - IP phones 15-2
 - ShoreGear-E1 16-4
 - ShoreGear-T1 16-4
- installation procedure, desktop 18-2
- Installation Readiness Review 1-6
- installation wizard screens 17-15
- installation, duration 18-14
- Installing Call Manager on Citrix or WTS F-1
- installing main ShoreWare server software 17-5
- installing Microsoft Windows Server 2003 components 17-2
- installing ShoreGear voice switch 16-1
- installing ShoreGear-40/8 voice switches 16-3
- installing ShoreTel system 1-2
- installing the distributed ShoreWare server software 17-15
- installing voice mail integration 18-12
- InstallShield Wizard 18-5
- InstallShield Wizard, preparing 17-5
- Installation
 - planning 1-2
- instruction modules 20-1
- instructor, asking questions 20-3
- integrated voice mail 8-7
- integrated voice network 14-1
- integrating legacy voice mail with SMDI 14-11
- integration plan 14-5
- integration with data network 9-2
- interactive tutorials 20-1
- interactive web session 20-2
- internal numbers, configuring 6-2
- Internal Only call permissions 7-2
- international
 - dialing plan considerations A-14
 - feature limitations A-3
 - telephones A-8
 - trunking A-8
- international (01x) dialing 6-6
- international deployment 1-1
- International Long Distance call permission 7-2
- international planning A-1
- Internet information server (IIS) default web site 10-5
- Internet Information service 17-2
- inter-site calling 14-5
- IP address
 - outside of range 15-5
- IP address assignment 9-18
 - DHCP server 9-19
 - firewalls with NAT 9-19
- IP Address Map 15-4
- IP address range, defining for IP phone 15-4
- IP address, static 15-1
- IP gateway D-3
- IP networks, ready for VoIP 9-3
- IP parameters, configuring manually for IP phones D-1
- IP parameters, displaying for phone D-6
- IP phone
 - installation 15-2
- IP Phone Cabling 13-8
- IP phone cabling C-5
- IP phone support, and voice switches 15-2
- IP phones
 - installing without DHCP D-1

- recommendations for installation 15-2
- IP Phones Options edit page 15-3
- IP phones, associating with user group 15-6
- IP100 8-4
- IP210 8-4
- IP530 8-4
- IP560 8-4
- IPBX-12 switch
 - audio input port 13-10, 13-11, 13-13, 13-14, C-8, C-9, C-10
 - audio output port 13-10, 13-11, 13-13, 13-14, C-8, C-9, C-10
 - described 13-10, ??-13-11, ??-13-12, ??-13-14, 13-14, 13-15-??, 13-15-??, C-8, C-9, C-10, C-11-??
 - RJ-21X port C-10
 - telephone ports 13-10, 13-13, 13-14, C-8, C-9, C-10
- IPSEC, and tunneling 9-25
- Ireland A-1
- ISDN BRI, and WANs 9-18
- ISDN PRI, call routing 4-13
- ISP limitations 8-4
- issues with voice traffic 9-9
- Italy A-1
- Italy, supported features 8-6

J

- jitter 8-3, 9-3, 9-9
 - and latency 9-10
 - changing buffer size 9-10
 - compensating for 9-10
 - underflows 9-10
- jitter buffer, non-configurable 9-11
- jitter for voice switches 9-10

K

- K56Flex/V.90 8-4
- key components, cabling voice network 13-19
- key considerations
 - addressing 9-2
 - bandwidth 9-2
 - service levels 9-2

L

- L2F, and tunneling 9-25
- L2TP, and tunneling 9-25
- language codes 9-21
- Language Licenses 18-16
- LANs 9-12

- latency 9-9, 9-10
 - end-to-end 9-10
 - traversing switch 9-10
- latency and jitter requirements 9-3
- Layer 2 IP Precedence 9-3
- Layer 3 - DiffServ 9-3
- Layer 4 UDP 5004 9-3
- Layer2Tagging 9-23
- leased T1, and WANs 9-17
- legacy integration
 - External Voice Mail Configuration 14-19
 - ShoreTel Voice Mail Configuration 14-19
- legacy PBX 14-4
- legacy systems 9-2
- license agreement 17-6, 18-6
- license terms 17-6, 17-12
- license types, three 18-16
- licenses, purchasing for users 18-16
- Line Build Out distance 16-7
- linear broadband encoding 9-4
- live operator, directing calls to 4-6
- lobby phones, planning for 8-3
- local area codes 6-5
- Local Area Network 9-12
- Local Only call permission 7-2
- local trunking 14-5
- location, server and data files 17-6
- log files, and disk space 10-4
- Logical Terminal Number, and extensions 14-12
- Logical Terminal Number, identifying PBX port 14-21
- long distance, consolidated 14-6, 14-29
- long-distance dialing 6-6
- loop length C-6
- lost packets 8-3
- lower-density trunking 3-6
- Lucent PBX 14-28

M

- MAC address 16-6
- MAC Ethernet address 13-8
- mailbox, purchasing license without phont extension 18-16
- Mailbox-only license 18-16
- main server, installing software 17-3
- maintenance cabling 13-9, C-7
- maintenance port 9-19
- maintenance port, switch 9-19
- Make Me Conferencing, support 16-6
- Malaysia, countries supported A-1
- management overhead, reducing with Citrix F-1

- managing your system 1-2
 - manually configuring the ShorePhone-IP100 D-1
 - map extension ranges 6-2
 - Master Clock Source button 16-7
 - mean time before failure (MTBF) 13-6
 - mean time between failure C-4
 - Media Encryption 9-29
 - media encryption
 - no support on legacy switches 9-30
 - supported hardware platforms 9-29
 - Memorized Phone Number Management 18-14
 - memory 17-16
 - memory requirements, ensuring 17-16
 - menu options D-3
 - Message Waiting Indicator 14-9
 - MGCP tab, for SoftPhone configuration 18-10
 - Microsoft DHCP server 15-6
 - Microsoft Outlook 12-3, 18-2, 18-9
 - Microsoft Transaction Server (MTS) 10-5
 - Microsoft Windows 2003 A-3
 - Miercom, testing by 9-3
 - mini-stereo input connector, 3.5 mm 13-9
 - mission-critical resources, protection 9-27
 - mixed dialing, configuring in same area 6-6
 - model number, ShoreGear switch 13-2
 - modems 8-3
 - monitoring agent extensions, training topics covered 20-4
 - monitoring calls in the queue, training topics covered 20-4
 - mono signal, audio output C-6
 - mounting IPBX ShoreGear voice switches C-3
 - mounting position C-3
 - MTBF C-4
 - multi-line phones, extension monitoring 8-3
 - Multi-Site Enterprise keys, renaming 18-16
 - Multisite Implementation, topologies 9-32
 - multi-site integration 14-5
 - multi-vendor network environment 9-3
 - Music on Hold cabling C-6
 - music on hold, streaming 13-9
 - Music Source check box, enabling 16-6
 - Music-on-hold
 - audio input port 13-10, 13-11, 13-13, 13-14, C-8, C-9, C-10
 - music-on-hold source, audio input port 16-3
 - music-on-hold, testing for cut-over 19-3
 - mute button, and speakerphone 8-7
- N**
- n11 dialing 6-7
 - National Long Distance call permission 7-2
 - Netherlands, countries supported A-1
 - NetScreen-5 9-26
 - Network Address Translation 9-28
 - network call routing 7-1
 - network call routing algorithm 7-5
 - Network Call Routing page 7-6
 - network infrastructure, ShoreTel deployment 9-3
 - network outages 9-12
 - network performance 9-2
 - network performance, maximizing 17-17
 - network requirements 12-3
 - bandwidth 9-11
 - jitter 9-11
 - latency 9-11
 - packet loss 9-11
 - network requirements, for fax 11-10
 - Network tab 18-11
 - Network Topologies, examples 9-31
 - network topology, determining 3-2
 - New Zealand, countries supported A-1
 - night bell 13-9, C-6
 - Nightbell
 - audio output port 13-10, 13-11, 13-12, 13-14, 13-15, C-8, C-9, C-10, C-11
 - Nortel PBX 14-28
 - notification, via email 18-2
 - NTFS partition 17-16
- O**
- online courses 20-1
 - online documentation 10-5
 - operating humidity 16-7, C-4
 - operating system 17-15
 - operating temperature 16-7, C-4
 - operating, call directing 4-6
 - Operator Assisted calls 7-2
 - Operator Call Manager, introductory training 20-2
 - operator call routing 4-7
 - operator digit A-14
 - Operator Training 20-2
 - operator-assisted dialing 6-7
 - operators, headsets for 8-2
 - operators, training 20-2
 - option 155 15-2, 15-5
 - Option 66 15-5
 - Order new trunk lines 1-3
 - ordering service 5-15
 - outbound caller ID 5-10
 - outbound calls, and analog wink-start 4-13

Outlook folder, moving messages 18-12
 Outlook, Microsoft 18-2
 overhead paging 13-9, C-6

P

package security, breaking 10-5
 packet loss 9-11
 packet loss requirements 9-3
 packet loss, for fax and modem calls 9-11
 packet loss, zero tolerance 8-4
 packets, lost during conversation 8-3
 packet-to-circuit conversions 8-4
 paging file size 17-16
 Paging system
 audio output port 13-10, 13-11, 13-13, 13-14,
 C-8, C-9, C-10
 paging system 16-3
 parity 14-11
 patch panel C-12
 patch panel installation 13-2
 PBX link 14-9, 14-27
 PBXLink, connecting to the PBX 14-27
 PBXs 9-2
 Pentium II 400 MHz 12-2
 performance, network 9-2
 Phillips screwdriver 16-5
 Phone and Modem Options control panel applet
 18-8
 phone extension license, requesting without mail-
 box 18-16
 Physical Requirements, ShoreGear voice switch
 13-3
 pinout 13-40
 pinouts
 connector C-14
 pinouts, connectors 13-21
 planning 1-2
 dialing configuration 6-2
 Planning and System Design 3-1
 planning fax handling 11-8
 planning recommendations 3-1
 planning voice switch installation 16-1
 playback device 18-12
 poor voice quality, causes 9-8
 port 5440 E-2
 power and heat dissipation C-3
 Power and Heat Dissipation, ShoreGear voice
 switch 13-5
 power cable
 disconnecting D-1
 Power Cabling 13-8

power cabling C-5
 power consumption, typical C-3
 power cord C-5
 power cord, protecting B-4
 power dissipation C-3
 power failure 8-7
 power interruption, ways to deal with C-3
 power loss, IP phones 9-13
 power requirements 1-4
 PPTP, and tunneling 9-25
 preparing users for ShoreTel implementation 20-
 1
 prerequisite software, installing 17-5
 preventing fire or shock hazard B-4
 PRI trunks 5-5
 PRI, and calling number information 14-2
 prioritizing voice traffic 9-3
 private numbers, not in System Directory 11-17
 proxy products, web access E-1
 proxy sites 6-4
 ProxyPass directive E-3
 PSTN services 14-5
 PSTN, delay in the 9-10
 public key infrastructure, encryption 9-26
 punch-down blocks 13-20, C-12
 purchasing a language license 18-16

Q

Quick Dial, importing Outlook contacts 18-14
 QuickStart training 20-1

R

rack installation 13-2, 13-20
 rack overview 13-20
 rack space and cabling, planning C-1
 rack, standard C-3
 racks and cabling 13-19
 receptionist, training 20-2
 receptionists, telephony needs 8-2
 recommendations for installing server 10-1
 recommendations, planning 3-1
 recommendations, training 20-2
 recording device 18-12
 reliability and availability, ShoreGear voice switch
 13-6
 remote administration 10-5
 remote switches, IP and Ethernet address 16-5,
 16-6
 remote TAPI service provider F-1
 Requirements
 cabling 1-4

- desktop 1-4
- power 1-4
- server 1-4
- trunk 5-1
- ventilation 1-4
- requirements
 - mounting voice switches C-3
- requirements of toll-quality voice 9-3
- requirements, for cut-over 19-2
- Requirements, server 10-1
- RESET# D-6
- Resource Scheduling and Tracking 1-5
- restart desktop 18-3
- restart server 17-8
- restrictions, call permissions 7-3
- resultant voice quality 9-15
- return call 11-7
- reverse proxy server E-1
- reverse proxy server, implementing E-1
- RJ-11 telephone and trunk connector 13-37, C-18
- RJ-21X cable retainer installation 16-5
- RJ-21X connector 13-2
- RJ-45 connectors for LAN interface 13-15
- RJ-45 LAN connector 13-37, C-18
- RJ-48C cable 13-2
- RJ-48C connector C-6
- RJ-48C connector for E1 interface 13-15
- RJ-48C connector for E1 monitoring 13-15
- RJ-48C T1/E1 and T1/E1 monitor connectors 13-39
- Routing Calls 4-1
- routing parameters 7-5
- routing, specify parameters for 7-6
- RS-232 link 14-27
- RTP data, encrypting 9-29
- RTP header compression 9-33
- RTP packet 9-8
- rules, digit collection 6-3

- S
- safety considerations, voice switch installation B-3
- safety, electrical B-4
- scroll and select D-3
- SDSL, and WANs 9-18
- secure communications 9-25
- security
 - media encryption 9-29
- security appliances, integrated 9-26
- security policies, firewalls 9-27
- self-paced online tutorials 20-2
- serial connection, configuring 14-26
- serial link, and voice mail integration 14-26
- serial port settings, extracting from Windows 14-26
- server
 - Apache E-2
 - server address D-4
 - server menu options D-4
 - Server Name, changing 18-18
 - server performance, optimizing 17-16
 - Server Requirements 10-1
 - server requirements 1-4
 - server, distributed 17-10
 - server, headquarters 17-9
 - server, remote access 10-5
- servers 3-2
- servers, terminal 3-3
- service level agreement 9-3
- service provider, SLA's with 9-3
- service, analog 5-13
- service, E1 PRI 5-15
- service, T1 5-14
- service, T1 PRI 5-15
- services
 - telephone 5-12
- services, recommendations for ordering 5-15
- setup menu, accessing D-1
- seven-digit local dialing 15-2
- ShoreCare ControlPoint 1-3
- ShoreCare QuickStart 20-1
- ShoreGear voice switch, address assignment 9-18
- ShoreGear-120/24 connectors 13-10
- ShoreGear-120/24 RJ-21X telephone and trunk connector 13-21, 13-23, 13-25, 13-30, 13-35
- ShoreGear-40/8 connectors 13-14
- ShoreGear-40/8 RJ-21X telephone and trunk connector 13-31, 13-33
- ShoreGear-40/8, installing 16-3
- ShoreGear-60/12 connectors 13-13
- ShoreGear-60/12 RJ-21X telephone and trunk connector 13-26, 13-28
- ShoreGear-E1 connectors 13-15
- ShoreGear-E1, installing 16-4
- ShoreGear-T1 connectors 13-15, 13-16, 13-17
- ShoreGear-T1, installing 16-4
- ShoreLink, additional training materials 20-2
- ShorePhone-AP100 8-4
- ShorePhone-IP100
 - menu interface D-2
 - rebooting D-1
 - rebooting with keys D-2

- ShorePhone-IP100 telephone, DHCP 9-20
- ShorePhone-IP100, manually configuring D-1
- ShorePhone-IP100/210/530/560 8-4
- ShorePhone-IP110
 - displaying settings D-6
 - manually configuring D-4
 - resetting D-6
- ShorePhone-IP210
 - manually configuring D-4
 - resetting D-6
- ShorePhone-IP530/560
 - manually configuring D-4
 - resetting D-6
- ShoreTel
 - remote TAPI service provider F-3
 - web access E-1
- ShoreTel 6 database 17-9
- ShoreTel 6 phones
 - simplified design 8-7
- ShoreTel 6 system, plug-and-play 13-6
- ShoreTel as PBX 14-8
- ShoreTel Conference Bridge 11-31
- ShoreTel Customer Operations website 16-3, 16-4
- ShoreTel installation 1-2
- ShoreTel superior design 9-3
- ShoreTel website 20-1
- ShoreWare Call Manager client, training on features 20-2
- ShoreWare Call Manager, dialing from 6-8
- ShoreWare Call Manager, installing 18-1
- ShoreWare server IP address 10-5
- ShoreWare Server, configuring for legacy voice mail 14-12
- ShoreWare server, naming 10-5
- ShoreWare Web Client E-2
- signaling overhead 9-3
- Simplified Message Desk Interface (SMDI) 14-6
- Simplified Message Desk Interface Mode
 - ShoreTel as PBX 14-18
- Singapore, countries supported A-1
- single point of failure C-4
- single site integration 14-5
- Single Site key, renaming 18-16
- single-extension plan A-14
- single-site implementation, topologies 9-31
- SIP 9-30
- SIP trunks 5-6
- Site page 7-2
- site requirements and preparation 13-1
- Sites and Users 3-2
- slave, T1 service 16-7
- smart Ethernet switches 9-12
- SMDI
 - functionality 14-7
 - history 14-7
 - supported features 14-27
- SMDI mode
 - ShoreTel Voice Mail 14-24
- SMDI parameters, configuring 14-21
- SMDI protocol support 11-5
- SMDI protocol support, and voice mail 14-7
- SMDI, configuring legacy voice mail integration 14-11
- SMTP 11-4
- SNTP address D-3
- SNTP Server 15-5
- SNTP server 15-5
- soft keys D-3
- SoftPhone 11-27, 12-3
- SoftPhone Configuration dialog box 18-11
- SoftPhone, configuring 18-9
- software configuration options, training 20-1
- software requirements 10-4, 12-3
- software upgrade requirements 12-2
- software, installing on main server 17-3
- Spain, countries supported A-1
- Spain, supported features 8-6
- Spanish language license 18-16
- Spanning Tree protocol 9-14
- Start bar F-2
- starting the ShoreWare Call Manager application 18-9
- static IP addresses 9-19
- static IP addresses, and servers 9-18
- status screen, client installation 18-7
- stereo jack 13-9
- storage temperature 16-7, C-4
- streamed music C-6
- subnet mask D-3
- superior design, ShoreTel 9-3
- supported PBXs 14-26
 - Avaya 14-26
 - Mitel 14-26
 - NEC 14-26
 - Nortel 14-26
 - Siemens 14-26
- surge protector 16-3
- Switch configuration ??–16-6
- switch configuration, and Director 16-5
- switch models 13-2
- switched Ethernet network 9-3

- System Administrator Training 20-4
 - system components 9-2
 - System Control Panel (Outlook Tab) 18-13
 - System Design 3-1
 - system installation checklist 1-3
 - System Load and Configuration 1-6
 - System Overview 2-1
 - system ownership 1-2
 - system verification 1-5
- T**
- t for the necessary configuration information. To continue, specify the location and area code information. Additionally, configure the dialing rules section with the appropriate inform 18-8
 - T1 lines, for modems 8-4
 - T1 PRI service 5-15
 - T1 service 5-14
 - T1/E1 Trunk and Trunk Monitor Cabling 13-9
 - tandem trunking 5-10
 - TAPI dialing parameters, configuring 18-8
 - TAPI service provider 17-8, F-1
 - TDM filtering, and media encryption 9-29
 - team, building 1-2
 - team, for monitoring cut-over 19-4
 - telco cable 13-20
 - telephone patch panel 13-19
 - Telephone requirements 3-2
 - telephone requirements, determining 3-3
 - telephone service, ordering 5-12
 - telephones, testing 19-3
 - telephony endpoints, providing access to F-5
 - Telephony Features
 - call recording 11-30
 - intercom 11-29
 - Make Me conferencing 11-31
 - Music on Hold 11-28
 - night bell 11-29
 - overhead paging 11-29
 - paging groups 11-29
 - telephony features, enterprise 11-28
 - Teleworker Sites 3-3
 - Teleworker sites 3-2
 - Teleworkers check box 15-4
 - teleworkers, telephony needs 8-3
 - temperature
 - operating 16-7, C-4
 - storage 16-7, C-4
 - terminal servers 3-3
 - Citrix and Windows F-1
 - terminal services 10-5
 - terminal services for ShoreTel clients 10-5
 - tie trunking 5-10
 - Time Services, SNTP 9-23
 - time zone information 15-5
 - time zone offset 15-5
 - toll-quality voice 9-2
 - toll-quality voice, requirements 9-3
 - tools, ShoreCare ControlPoint 1-3
 - Topics Covered
 - End-User Training 20-2
 - Operator Training 20-2
 - Topics covered
 - Workgroup Training 20-4
 - topics covered
 - System Administrator Training 20-4
 - topology diagram 3-2
 - topology, VPN 9-25
 - traffic calculations 5-10
 - traffic calculator 3-6
 - traffic shaping 9-26
 - traffic shaping, reduce bottlenecks 9-14
 - Training 20-1
 - Training Materials 20-2
 - training program, virtual 20-1
 - training, topics covered 20-2
 - Transfer Using Flash feature 14-17
 - trunk
 - access codes A-14
 - trunk access code, defaults 6-8
 - trunk cabling C-5
 - Trunk Considerations 4-3
 - trunk considerations 4-6, 4-11
 - trunk digit manipulation, specifying 6-10
 - trunk features, understanding 5-7
 - trunk group edit page 7-4
 - Trunk Group edit page, call routing 7-6
 - trunk lines, ordering 1-3
 - trunk monitor cabling C-6
 - Trunk Planning and Ordering 5-1
 - trunk ports 13-10, 13-13, 13-14, C-8, C-9, C-10
 - Trunk Requirements 5-1
 - Trunk requirements 3-2
 - trunk requirements 14-4
 - trunk services, defining 7-5
 - Trunking Cut-Over 19-3
 - trunking, tandem 5-10
 - trunks
 - analog wink-start 4-9, 5-4
 - digital loop-start 5-4
 - digital wink-start 4-9, 5-4
 - E1 PRI 5-6

- PRI 5-5
 - SIP 5-6
 - T1/E1 4-9
 - trunks, conditions for availability to hunt groups 7-4
 - trunks, determining requirements 3-5
 - trunks, digital 7-5
 - trunks, installing before cut-over 19-2
 - TSPInstall command line F-2
 - TSPinstall utility, running F-2
 - TspInstall.exe F-2
 - tunneling 9-25
 - tutorials, interactive 20-1
 - tutorials, online self-paced 20-2
- U**
- UDP port 5004 9-8
 - UDP ports for voice traffic 9-5
 - UK, countries supported A-1
 - unassigned IP Phones, associating with user group 15-6
 - uninterruptable power supply C-3, C-5
 - uninterruptable power supply (UPS) 13-8
 - unique dialing plan 6-4
 - unique line identifier, Windows Dialer F-5
 - United Kingdom, supported features 8-6
 - United State, outside of A-1
 - unroutable numbers 6-10
 - upgrade disk requirements 12-2
 - Upgrade Procedures 18-15
 - upgrades, simplifying F-1
 - upgrading software on the headquarters server 17-9
 - upgrading software, distributed server 17-15
 - UPS C-5
 - UPS, uninterruptable power supply 13-4
 - UPS, uninterruptible power supply C-3
 - user license types
 - Extension and mailbox 18-16
 - Extension-only 18-16
 - Mailbox-only 18-16
 - User Licenses, purchasing 18-16
 - User Licensing 18-16
 - User training, completing before cut-over 20-2
 - using a fax server 11-9
 - using toolbar shortcuts, training topics covered 20-4
 - utilization, hard disk space 10-3
- V**
- variation of latency, jitter 9-10
 - velcro strap 16-5
 - Vendor Specific DHCP Option 155 15-5
 - Vendor Specific DHCP Option 156 15-5
 - ventilation requirements 1-4, 13-5, C-3
 - verification 1-5
 - vertical service code dialing 6-7
 - Vertical Service Codes 7-2
 - viewing IP address range for a site 15-4
 - virtual LANs 9-13
 - Virtual Private Network (VPN) 9-24
 - virtual training program 20-1
 - VLAN Assignment 9-22
 - VLAN ID D-3
 - Voice Communications System Analysis 1-3
 - voice encoding 8-3
 - G.729a 9-33
 - Voice encoding scheme 9-3
 - voice mail 11-3
 - COM port 14-10
 - message waiting light 14-7
 - notification 14-9
 - voice mail storage 10-3
 - voice mail systems, multiple 9-2
 - voice mail, AMIS 14-6
 - voice mail, and disk usage 10-3
 - voice mail, SMDI 14-7
 - Voice Over IP, advantages of 9-2
 - voice quality, resultant 9-15
 - voice switch
 - installation 16-1
 - specifications for C-3
 - voice switch requirements 13-3
 - voice switches
 - UPS C-3
 - voice switches, instructions for installing 16-3
 - voltage, input C-3
 - VPN 9-9
 - VPNs
 - extranets 9-24
 - intranets 9-24
 - remote access 9-24
- W**
- WAN 9-2
 - bandwidth requirements 9-17
 - connections 3-2
 - connectivity between locations 9-17
 - outages 11-5
 - WAN bandwidth 9-9
 - WAN links, flooding 9-3
 - WANs

- ADSL 9-18
 - cable modems 9-18
 - dial-up modems 9-18
 - frame relay 9-17
 - ISDN BRI 9-18
- WANs, and IDSL 9-18
- WANs, and leased T1s 9-17
- WANs, SDSL 9-18
- WANs managing bandwidth 9-13
- Web Access 11-19
- web access E-1
- website address 16-3, 16-4
- welcome window, and software installation 17-12
- wild-card characters, with call permissions 7-3
- Windows
 - servers 3-3
 - terminal server 12-3
- Windows Control Panel F-3
- Windows Server 2003 10-5
- Windows Server 2003 components, installing 17-2
- Windows XP Professional 12-3
- Wizard, for client installation 18-5
- workgroup agents, headsets 8-2
- Workgroup Training 20-4
- Workgroups 11-24
 - agent multiplicity 11-24
 - call monitor and barge in 11-24
- workgroups, empowering 20-4