

User Manual for

2N StarGate

(507000E, 507001E , 507002E, 5070101E, 507010E)

2N BlueStar

(507200E, 507210E)

2N BlueTower

(507310E)



Version: 1.8p

This user guide contains installation and technical information about three types of 2N GSM Gateways :

2N StarGate , 2N BlueStar , 2N BlueTower.

In cases that feature will be same for all three types, gateway name will be "PRIGW". In the other cases you find information for each type of gateway divided.

Dear customer,

We congratulate you on purchasing your **2N** product. This new product was developed and produced with emphasis on maximum utility value, quality and reliability. Our wish is to make you satisfied with the StarGate / BlueStar / BlueTower (PRIGW) completely and for a long time.

! Important !

- The manufacturer is gradually improving the control program that is included in this product (referred to as firmware and bootware). The used ISP (In System Programming) technology gives you the possibility to store the most recent control program in your PRIGW by means of a standard computer. The most recent version of the program together with all that is necessary can be found in www.2n.cz and necessary instructions in the chapter **“Upgrading the control program”** of this manual. It is recommendable to use the most recent version of the program – thus, you will avoid unnecessary encounters with possible shortcomings that have been eliminated already.
- If you program parameters of your PRIGW by means of your computer, you will need the “PRIGW program“. You will find the most recent version of this programming tool in www.2n.cz as well.
- In www.2n.cz you will also find the most recent version of this manual in the popular PDF format. We recommend you to use it especially in connection with the control program upgrade since the new functions are explained here.
- Before you start installing this product, check whether the delivery is complete with the following packing list and read this manual thoroughly. The manufacturer cannot be held responsible for any damages that occurred due to incorrect use of this product in contradiction to this manual. The guarantee terms do not cover damages of the product caused by rough handling, incorrect storage or by exceeding the quoted technical parameters.
- Preliminary information about functions that are not available yet are differentiated by light grey background or by grey letters instead of black ones.

CONTENTS

1. DESCRIPTION - GENERAL DESIGN	5
1.1. DIMENSIONS	5
1.1.1. <i>Basic Dimensions</i>	5
1.1.2. <i>Front Side Division</i>	5
1.1.3. <i>Front side division for gateways with VoIP interface</i>	6
1.2. AVAILABLE SOFTWARE	6
1.3. POWER SUPPLY.....	6
1.3.1. <i>Description</i>	6
2. DESCRIPTION – MAIN FEATURES	7
3. DESCRIPTION – PLUG-IN BOARDS	12
3.1. CPU BOARD	12
3.1.1. <i>Board Description</i>	12
3.1.2. <i>COM1 Serial Interface Parameters</i>	12
3.1.3. <i>Lithium Battery Replacement</i>	13
3.1.4. <i>Configuration Jumpers</i>	14
3.2. AUX BOARD	15
3.2.1. <i>Board Description</i>	15
3.2.2. <i>COM2 Serial Port Parameters</i>	15
3.2.3. <i>Configuration Jumpers</i>	16
3.3. PRI BOARD.....	17
3.3.1. <i>Board Description</i>	17
3.3.2. <i>Configuration Jumpers</i>	18
3.4. VOIP BOARD.....	20
3.4.1. <i>Board Description</i>	20
3.5. THIN VOIP BOARD	20
3.6. GSM BOARD.....	21
3.6.1. <i>Board Description</i>	21
3.6.2. <i>Configuration Jumpers</i>	22
3.7. 3G ONE CHANNEL CARD	24
3.8. 3G TWO CHANNEL CARD	25
4. ANTENNA SPLITTER	26
5. DIRECTIONAL GSM ANTENNA	28
6. DISCREET ANTENNA	29
7. INSTALLATION	30
7.1. FIRMWARE VERSION AND LICENSE.....	30
7.2. GSM NETWORK LIMITATION.....	31
7.3. INSTALLATION CONDITIONS	32
7.4. POTENTIAL GSM NETWORK PROBLEMS	32
7.5. MAIN INSTALLATION	33
7.5.1. <i>Control Ways</i>	33
7.5.2. <i>Configuration Ways</i>	33
7.5.3. <i>Your first installation (quick step by step guide)</i>	33
7.7. CONFIGURATION OF 12 HP VOIP BOARD.....	35
7.7.1. <i>Main description of VoIP board</i>	35
7.7.2. <i>Default Settings</i>	35

7.7.3.	<i>VoIP Board Configuration (Web Interface)</i>	36
8.7.3	<i>VoIP Board Firmware Upgrade</i>	37
8.	CONFIGURATION OF VOICE CALLBACK CENTER SOFTWARE	42
8.1.	SCHEME OF FUNCTION OF VOICE CALLBACK	42
8.2.	INSTALLATION AND LICENSES	42
8.3.	CONFIGURATION OF VOICE CALLBACK CENTER SOFTWARE	47
9.	STARGATE / BLUESTAR / BLUETOWER PROGRAM USER MANUAL	49
9.1.	PROGRAM INSTALLATION	49
9.2.	PROGRAM RUNNING	49
9.3.	CONNECTION WITH PRIGW	50
9.4.	MAIN MENU AND BUTTON BAR.....	50
9.5.	CONFIGURATION.....	61
10.	ACCOUNTER PROGRAM	80
11.	APPENDIX A - AT COMMANDS FOR COMMUNICATION	84
12.	APPENDIX B – LIST OF ALL STATUS CODES	90
13.	APPENDIX C - DESCRIPTION OF CDR LINE	97
14.	APPENDIX D - DESCRIPTION OF STATISTICS	97
15.	APPENDIX D - TECHNICAL CONDITIONS FOR INSTALLATION	99

2N StarGate / BlueStar / BlueTower

PRIGW is a compact yet highly sophisticated system. It supports full remote supervision and configuration via an IP network, or using an external modem over a BRI-ISDN and analog line, or over a B channel in a PRI-ISDN trunk. The system has been designed and works with a lot of highly sophisticated functions, which make it fully client-oriented and highly reliable in cooperation with both GSM networks and ISDN. In addition, it provides full monitoring and comfortable configuration without functional limitations. Configuration alterations can be made without resetting, i.e. under full operation. Hot-swappable plug-in GSM boards, which can be swapped under full operation including SIM cards, are a matter of course. The use of up to four SIM cards per GSM module in combination with an intelligent SIM card switching tool and detailed statistics upgrade this system into a powerful LCR tool. High product stability is achieved by the fact that the gateway is programmed in the ASM, i.e. OS-FREE system. Two independent 30MHz Philips microprocessors provide an error-free operation, high speed, automatic fault detection, and easy upgrade. The system also features easy installation, simple operation and easy replacement of defective parts - it is composed of plug-in boards that communicate along system buses independently. As already mentioned, the system allows for an easy detection of defective parts, automatic locking against use and easy replacement (hot-swap). Thanks to the above mentioned properties, the system can be installed and configured successfully within one hour!

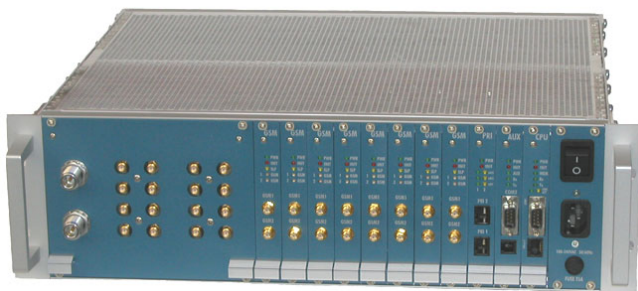

2N BlueStar



2N StarGate



2N BlueTower

1. Description - General Design

1.1. Dimensions

1.1.1. Basic Dimensions

1.1.1.1 2N StarGate / BlueStar

The system is integrated in a 19" subrack of the height of 3U and depth of 360mm. The front side is open, equipped with guides for plug-in boards with front panels – the panel including a mains switch is part of the subrack. In case not all GSM boards are plugged in, the free section of the front side must be covered with a fixed panel (fixed panels).

The back side is completely covered with a panel with a built-in ventilator, which is switched by a thermostat for higher reliability and longer life. An AC mains supply unit is located in front of the ventilator. The bottom and upper sides are covered with perforated sheet, the assembly flanges are provided with handrails.

The system bus is designed as a printed circuit board (PCB) with DIN connectors and fitted to the inner subrack carrier profiles.

1.1.1.2 2N BlueTower

The system is integrated in a small 19" subrack of the height of 3U and depth of 320mm. The front side is open, equipped with guides for plug-in boards with front panels – the panel including a mains switch is part of the subrack. In case not all GSM boards are plugged in, the free section of the front side must be covered with a fixed panel (fixed panels).

The system bus is designed as a printed circuit board (PCB) with DIN connectors and fitted to the inner subrack carrier profiles

1.1.1.3 2N StarGate 3G Extension rack

To use 2N StarGate with 3G extension card you need an extension rack (part No. 507050E). This 19" subrack is 6U high and 360mm deep. Its front side open to accept plug-in boards. There are two antenna connectors for 3G YAGI antennas on its backside. Before attaching the 3G extension rack you have to replace the existing StarGate GSM cards with 3G extension cards (part No. 507059E).

1.1.2. Front Side Division

The subrack width is divided into an 8HP-wide mains panel and 19 4HP-wide modules in the following sequence (from right to left):

Board Type	Size	StarGate	BlueStar	BlueTower
8HP fixed panel with a mains switch, fuse and mains cable socket	8HP	YES	YES	NO
CPU board	4HP	YES	YES	YES
AUX board	4HP	YES	YES	YES
PRI board	4HP	YES	YES	YES
GSM board	4HP	Up to 16x	Up to 8x	Up to 4x
3G extension card	4HP	Up to 16x	NO	NO
3G card (one channel)	4HP	Up to 16x	Up to 8x	NO
3G card (two channels)	4HP	Up to 16x	Up to 8x	Up to 2x
Thin VoIP card	4HP	YES	YES	YES
Internal antenna splitter BlueStar	32HP	NO	YES	NO
Internal antenna splitter BlueTower	8HP	NO	NO	YES*

1.1.3. Front side division for gateways with VoIP interface

The subrack width is divided into an 8HP-wide mains panel and 19 4HP-wide modules in the following sequence (from right to left):

Board Type	Size	StarGate	BlueStar	BlueTower
VoIP board	12HP	YES	YES	NO
CPU board	4HP	YES	YES	YES
AUX board	4HP	YES	YES	YES
PRI board	4HP	NO***	NO***	YES
GSM board	4HP	Up to 16x	Up to 8x	Up to 4x
3G card (one channel)	4HP	Up to 16x	Up to 8x**	Up to 4x**
3G card (two channels)**	4HP	Up to 16x	Up to 8x	Up to 2x
Thin VoIP card	4HP	YES	YES	YES
Internal antenna splitter BlueStar	32HP	NO	YES	NO
Internal antenna splitter BlueTower	8HP	NO	NO	YES*

1.2. Available Software

PRIGW program	- tool to configure and control of the gateway
Accounter tools	- tools for automatic download and handling with CDR information

1.3. Power Supply

1.3.1. Description

The system uses an industrial mains supply unit with primary (input) voltage of 100-240VAC 50/60Hz and secondary (output) voltage of 5V/30A or 5V/4A with natural cooling and an auxiliary external ventilator, which is switched on *automatically* whenever the power supply temperature exceeds 70°C. The supply is designed with a 30% reserve even under the maximum load.

Type of power supply	Active cooler	StarGate	BlueStar	BlueTower
Internal 90-260V/50-60Hz = 5V/30A	YES	YES	YES	NO
Internal 48DC	YES	YES	YES	NO
Internal 90-260V/50-60Hz = 5V/10A	NO	NO	NO	YES

*type of power supply depends on order number

2. Description – Main Features

Quick unit start – being free of an operating system (programmed in the processor code), the system is completely ready to work within 30 seconds following its power on/restarting. Of course, the full function time of all GSM modules depends on the actual load and capacity of GSM networks to which the PRIGW is connected.

Intelligent call processing – the PRIGW is fully prepared to route PRI-ISDN outgoing calls into GSM networks or back to second PRI ISDN interface and vice versa. A fully intelligent LCR (Least Cost Routing) function is the basic tool, allowing to route outgoing ISDN calls to GSM networks (or ISDN network) both by the called number prefix, and current date and time and GSM module load in the particular group (LCR function is only on PRI 1 port, all calls to PRI 2 port will be directly rerouted to PRI 1 interface). Functions taken over from dialers, which enable to replace a part or whole of the dialed number with another number, are a matter of course. Calls incoming from GSM networks can be ignored (the calling party hears the ringing tone), fully rejected (the calling party gets the busy tone/voice message), or received. In the last-named case, the DTMF dialing in combination with voice messages, or direct connection to the operator(s) can be selected (calls can be routed only to PRI 1 port). Using the 2N RCU (see later), or XAPI with NQuire support, you can get a highly powerful routing tool, which contains so-called blacklist charts – barred numbers - and practically unlimited routing charts. This combination is extremely useful for installation sites with the so-called full telephone number carryover where a plenty of numbers come into being whose prefixes do not match the official prefixes of providers.

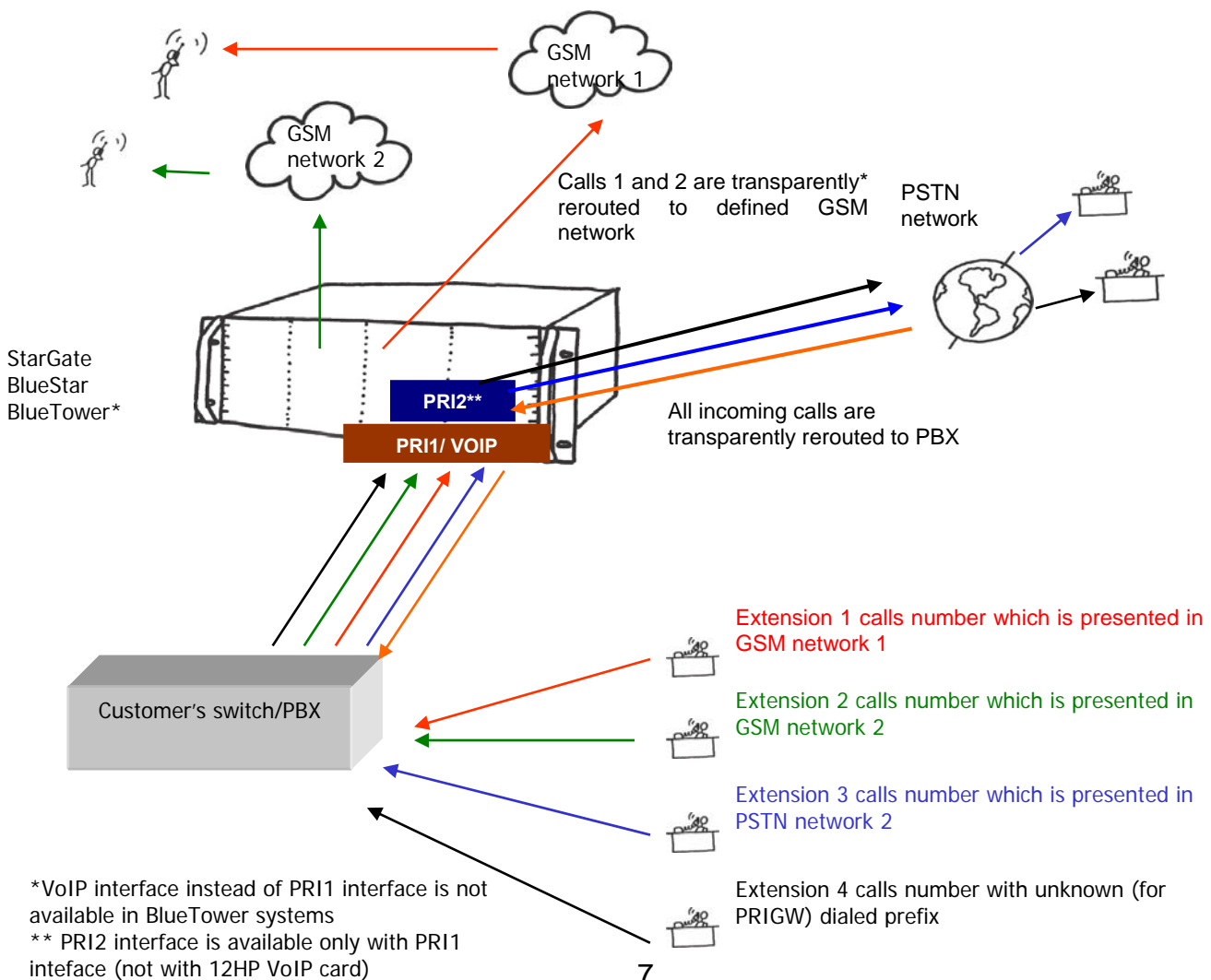

Example of call cost reduction with using of PRIGW with Thin VoIP card

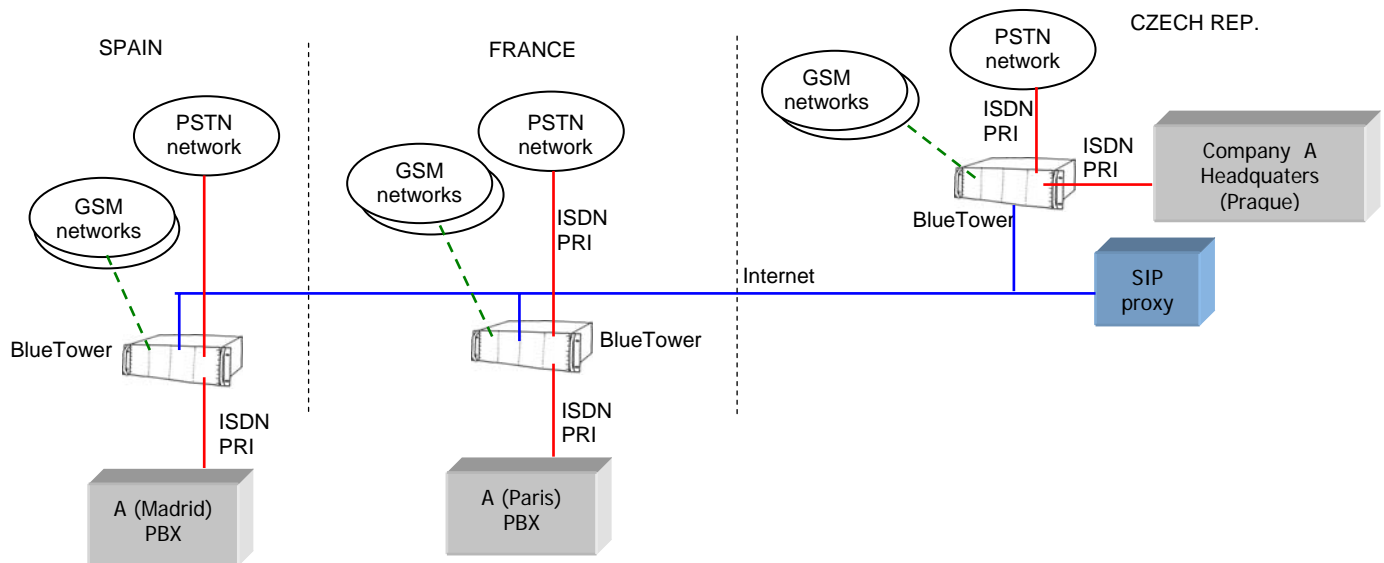

- BlueTower with Thin VoIP card you handle with 2xPRI ISDN interfaces, 4xVoIP-SIP interface and up to 4xGSM interface.

Selection of GSM module use – the PRIGW allows you to select one of three available ways of GSM module occupation: 1. Any outgoing call is set up via a GSM module according to the B channel used. This option helps transfer routing functions to a connected PBX router. 2. This mode allows to occupy GSM modules in groups cyclically, and 3. the last option helps select GSM modules in a group according to the number of minutes called (the counting mode can be predefined of course).

GSM network friendly – the PRIGW allows activating the automatic GSM module log-out in certain time intervals. Using this function you can log out and disable automatically unused GSM modules at defined time intervals. Since the time between the GSM module activation and readiness for work is roughly 10-25 seconds, a user-defined hot reserve is maintained, i.e. some GSM modules keep logged in. This means that any increase in the 2N PRIGW load result in an automatic activation of other GSM modules so that the hot reserve be maintained. This feature also reduces the capacity of the GSM network to detect a unit and disconnect it from the mains.

High connection rate – since GSM networks are not quite reliable and show lack of capacity occasionally, the PRIGW is equipped with the automatic call forwarding to other GSM networks or call rejection (without call loss). This function uses the ISDN signaling protocol where a call SETUP message is sent to the PRIGW first. This message contains the called number and CLIP if necessary. Having received this message, the 2N PRIGW can either: reject the call (the other party will route it to another device), REJECT message including reasoning (CAUSE), or receive and connect the call – SETUP.ACK message.

The device on the other side awaits one of the above mentioned responses for 2 seconds. During this time, PRIGW has to decide whether it is able to set up the call, tries to find a free GSM module and establish connection. If the selected GSM module is busy, it must find other free GSM modules. If it fails to find a free route, it rejects the call request. The CAUSE number is user-defined. If it succeeds, it receives and sets up the call.

Detailed statistics – provides a detailed overview of the count of incoming and outgoing calls and their successful connections. The statistic data can be displayed either globally for the whole PRIGW, or for the selected GSM provider, or the selected GSM module (SIM card). These data are generated automatically.

Detailed call information – the PRIGW can save information on completed calls automatically (CDR). Call information includes:

- call beginning date and time
- call type
- I-FD : Not connected incoming call
- I-OK : Successfully connected incoming call
- O-FD : Unsuccessful outgoing call
- O-OK : Successfully connected outgoing call
- Relation end reasoning (CAUSE) sent to ISDN interface
- Number of B channel used
- Number of GSM module used
- Number of GSM group used
- Connection setup time
- Call duration mmm:ss (max. 255:59)
- Call cost (if pseudo tariff metering is enabled)
- ID of the gateway
- Called number
- CLIP
- SIM card position number
- SIM card IMSI or SCID

High number of connected calls – owing to a very short GSM call connecting (routing) time and intelligent call rerouting in the event of failure, PRIGW features high call time per month (traffic volume of over 500,000 minutes/month). The connectivity depends on PRIGW configuration and GSM network capacity of course.

Gateway	Traffic volume (minutes/month)
StarGate	Over 500.000
BlueStar	Over 250.000
BlueTower	Over 125.000

SMS receive/send support – PRIGW helps send and receive SMS in the PDU format. An intelligent SMS sending over a selected GSM network or module and automatic announcement of incoming SMS are a matter of course.

Up to 8 GSM groups – you can define up to 8 independent SIM card groups in the system. For example, one GSM group can contain one provider's SIM cards.

Up to 16 GSM modules – the PRIGW is a modular system where 1 to 16 GSM boards with two GSM modules each can be installed. The GSM boards are hot-swappable, i.e. can be replaced easily during operation.

Gateway	Maximum number of GSM modules
StarGate	32
BlueStar	16
BlueTower	8

Up to 64 SIM cards – each GSM board contains 16 SIM card holders. However, two SIM cards are only connected to the GSM modules at one moment. An intelligent SIM card switching according to time, at random intervals, according to completed minutes or sent SMS enables a client-oriented approach. A defective SIM card blocking is a matter of course.

World wide use– GSM/3G boards are currently available with GSM modules from Siemens TC35i (900/1800MHz), MC55i (850/900/1800/1900MHz) and Wavecom (850/1900MHz or 900/1800MHz). 3G modules SierraWireless (All UMTS and GSM bands).

Virtual SIM card support – PRIGW supports [2N SIM Star system](#).

One antenna per system only – *One* receive/transmission antennas can be used in combination with an antenna splitter (see below) for all of up to 16 GSM modules.

Gateway	Number of antennas with using antenna splitter
StarGate	2
BlueStar	1
BlueTower	1

Hot-swappable boards – as mentioned above, all GSM boards are hot-swappable. As a matter of course, the access to the GSM board can be restricted upon the user's request. This solution provides an easy SIM card replacement during operation.

Support Callback – PRIGW supports to make call to GSM and after connection make call to PRI interface and connect both calls. This feature can be controlled by AT command or XAPI server SW (easy to implement it to some additional callback SW, or you can use 2N callback software)

CLIP routing – according incoming CLIP from GSM network the gateway can route the call to defined number in PRI ISDN

AutoCLIP routing – PRI GW can store Calling and called numbers in case of outgoing call to GSM network. In case that somebody calls from GSM network and have CLIP same as stored Called number, the gateway will automatically reroute the call to defined PRI ISDN number.

2x PRI ISDN interface – is configurable in all available modes, i.e. as Network Termination (NT), or Terminal Equipment (TE). It can also be set as a Master (synchronization clock) or a Slave. Using PRI board switches you can easily select RX and TX directions – hence, you can use a cross-over or not-cross-over cable for the PRIGW <> PBX (Switch) connection.

VoIP interface – supporting SIP signaling and following codec: G.711, G.723, G.729. With using VoIP interface you can use only one PRI ISDN interface***.

Easy control and configuration – The PRIGW can be configured locally or remotely. To do this, you can employ the following types of connection:

- 2 local RS232 interfaces;
- remote control by an external analog, ISDN, or GSM modem connected to a defined RS232 interface. Automatic detection and configuration capacities make the modem perfectly available.
- remotely via a 10baseT IP interface, using a simple Telnet protocol;
- remotely by the in-band B channel in the PRI-ISDN interface**.

No SW is necessary for configuration – system communicates through an RS232 interface and Telnet protocol using standard extended AT commands. However, high-quality software running under the Windows OS has been designed for user-friendly control and configuration.

Fault diagnostics is very simple too – system informs of a fault both visually (by LED diodes) and via any interface. A direct display of all processes on ISDN or IP layers is a matter of course too.

Quality control – you can check the quality of system calls any time by test calls (an analog headset connector is available for test calling into GSM networks or ISDN interface) or by-hearing of one of the two current call directions.

Quick and easy update – since PRIGW is not bound to any operating system, any firmware updating is quick and comfortable and is made by the available software. Updating can be performed locally or remotely and the process is protected against unintentional disconnection. The updating process takes a few minutes and the existing configuration is retained.

**** optional part**

***** actually not possible, but it will be possible to replace 1. GSM card by 1x PRI card.**

3. Description – Plug-In Boards

Warning: GSM boards are always locked for one type of gateway. See table below for more information:

Plug-in board	StarGate	BlueStar	BlueTower
CPU card StarGate	YES	NO	NO
CPU card BlueStar	NO	YES	NO
CPU card BlueTower	NO	NO	YES
AUX card StarGate	YES	YES	YES
AUX card BlueStar	YES	YES	YES
AUX card BlueTower	YES	YES	YES
PRI card StarGate	YES	YES	YES
PRI card BlueStar	YES	YES	YES
PRI card BlueTower	YES	YES	YES
GSM card StarGate	YES	NO	NO
GSM card BlueStar	NO	YES	NO
GSM card BlueTower	NO	NO	YES
12HP VoIP card	YES	YES	NO
4HP Thin VoIP card	YES	YES	YES
3G two channel card StarGate	YES	NO	NO
3G two channel card BlueStar	NO	YES	NO
3G two channel card BlueTower	NO	NO	YES

3.1. CPU Board

3.1.1. Board Description

The CPU board contains a powerful processor system controlling the whole system. The board is designed on a 4-layer PCB of the size of 160x100mm. A simple serial interface COM1, an Ethernet connector (10Base-T), and 5 board status LED indicators are located on the front panel.

PWR LED	indicates board supply (LED is green in case of PRIGW)
INIT LED	indicates board initialization or error status
MEM LED	indicates call memory full (not shining=empty memory, blinking 1:1 memory is 50% full, shining = 100% full memory)
LINK LED	indicates connection to Ethernet
ACT LED	indicates activity via Ethernet

3.1.2. COM1 Serial Interface Parameters

The COM1 interface is used as a local port for temporary connection of a PC (terminal) for installation and servicing purposes and permanent connection of the SMS server (supervision PC). It allows to provide local monitoring, configuration, tracing and firmware upgrade.

Transmission rate	57.6 kBd
Bit format	start, 8bit, stop (no parity)
Signals	RXD, TXD, RTS, CTS, GND

3.1.3. Lithium Battery Replacement



WARNING! Incorrect battery replacement may cause explosion. The battery can be replaced with a battery of the same or equivalent type only as recommended by the manufacturer. Handle used batteries as instructed by the manufacturer.

The lithium battery on the CPU board backs up the internal real time clock in case of supply power outage. Its average life is about three years, then it is advisable to replace it preventively. Replacing the lithium battery, be sure to turn the subrack power supply off using the mains switch and, having loosened two fitting screws, push the CPU board out. Remove the old battery from the holder using a suitable tool and insert a new one. Restore the original status taking the said steps in the opposite order. **Battery type: CR2430.**



WARNING! Never use metal tools for battery replacement; neither the new nor the old battery may be short-circuited! A short-circuit may result in battery damage or explosion!!!

Dispose of used batteries in accordance with applicable regulations, put them in a recycling yard, for example.

3.1.4. Configuration Jumpers

There are three configuration jumpers on the CPU board. Jumper JP1 is intended for a change of the board addressing and is not used at present. It need not be applied during a common firmware upgrade. By default, jumper JP1 is disconnected. JP2 is intended for switching serial port between CPU board and optional extension board. By default, jumper JP2 are connected.

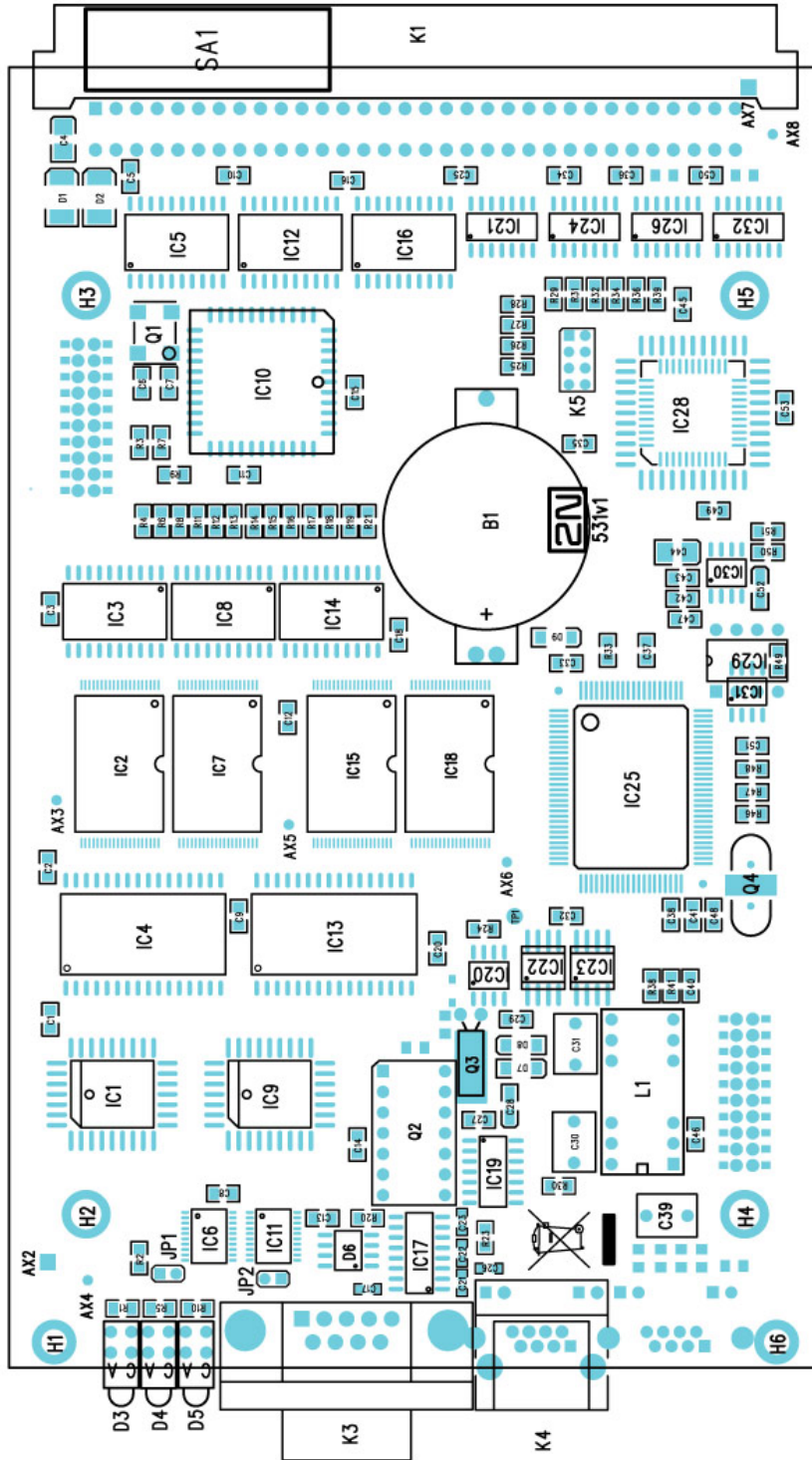

3.2. AUX Board

3.2.1. Board Description

The AUX board contains a switching array and system of voice messages, controlled by an independent processor system separated from the system bus. The AUX port is used for making testing calls or recording voice messages. The input amplifier is designed for an electret microphone, the output amplifier for 150ohm earphones. The board is designed on a 4-layer PCB of the size of 160x100mm. A serial interface COM2, microtelephone or headphone connector, and 5 board status indicators lead to the front panel.

PWR LED	Indicates board supply
Lights on	Switched on
Lights off	Switched off
Blinking	Board in sleep mode
INIT LED	Indicates board initialization or error status
Blinks	Indicates the initialization of the board
Lights on (45 sec)	Indicates duplication of the new firmware
Lights on (still)	Board initialization failure
AUX LED	indicates activity on AUX port (analogue interface)
Lights on	Waiting for incoming call (AT!W...)
Blinks	Indicates the call through the testing AUX interface
Lights off	The testing interface on-hooked.
Rx LED	indicates reception via COM2
Tx LED	indicates transmission via COM2

3.2.2. COM2 Serial Port Parameters

The COM2 interface is used a supervision port for remote connection of a PC (terminal) using ISDN or analog modem (also for loading voice message into the AUX board processor memory). It allows to provide remote monitoring, configuration, tracing and firmware upgrade.

Transmission rate	57.6 kBd
Bit format	start, 8bit, stop (no parity)
Signals	complete 9-pin wiring

3.2.3. Configuration Jumpers

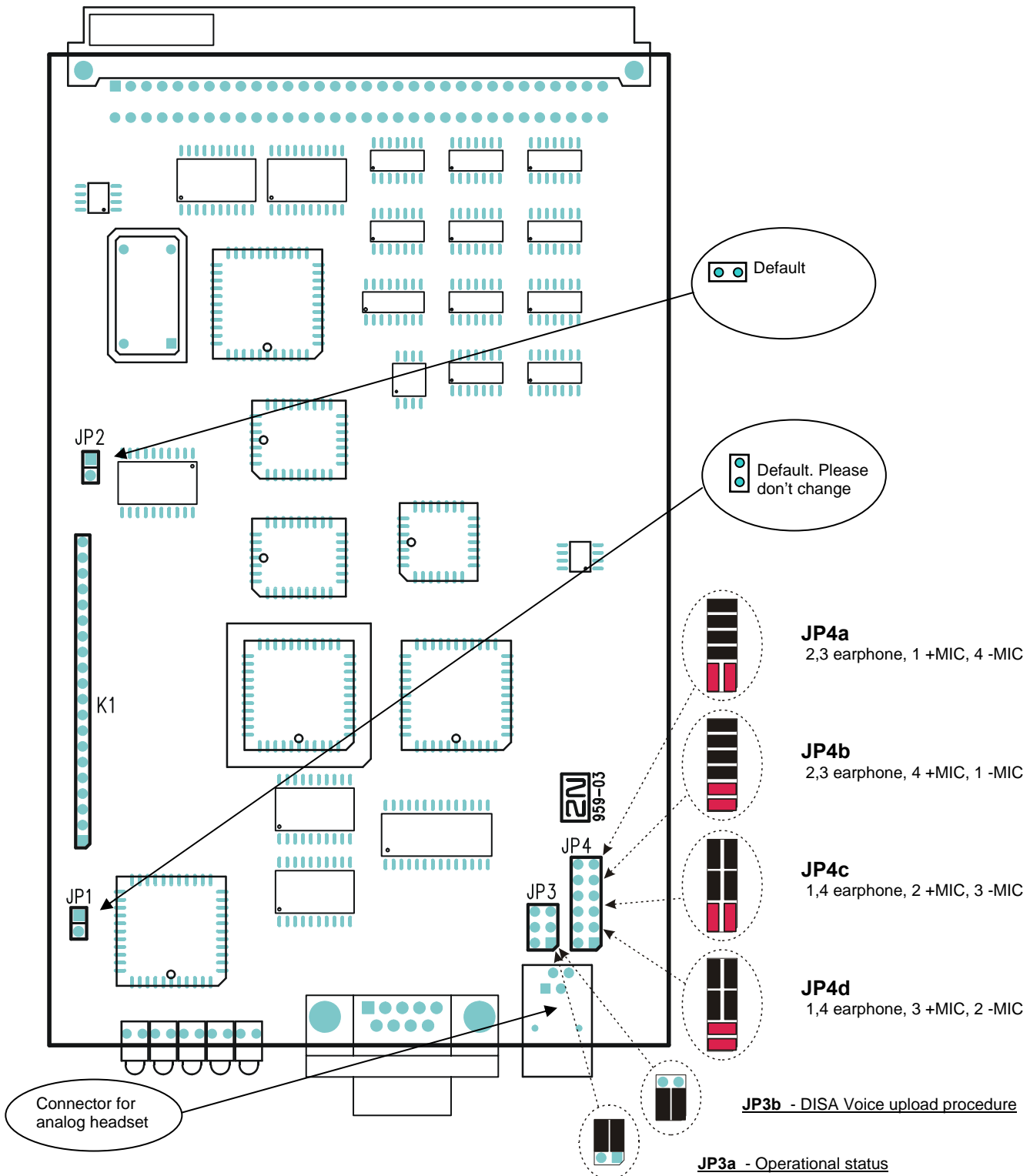

There are four configuration jumpers on the AUX board. Jumper JP1 is intended for a change of the board addressing and is not used at present. The field of jumpers JP3 helps you redirect the COM2 interface for upload the DISA voice message. The jumper field JP4 is used for setting the AUX interface to correspond with the microtelephone or headphone configuration. Connector K1 is intended for servicing purposes only and may not be used. By default, jumpers JP1 and JP2 are disconnected, jumper JP3 is connected as shown in Fig. JP3a and jumper JP4 as shown in Fig. JP4a.

3.3. PRI Board

3.3.1. Board Description

The PRI board contains an one or two ISDN interfaces and PCM bus timing circuits. PRI 1 interface is designed as internal (on this port is activated LCR function), PRI 2 port is designed as external (all calls from the port will be routed to PRI 1 port). The interface can work in the MASTER or SLAVE mod (via PRIGW program you can set mode of PRI 1 port, PRI 2 port has always opposite mode!). The output can be configured as TERMINAL or NETWORK by jumpers (switching of wires – for software switch you have to use PRIGW program!). These jumpers HAVE TO be set same as PRI configuration – two NT and TE modes will cause malfunction of PRI board or backup connection* ! The board is designed on a 4-layer PCB of the size of 160x100mm. A PRIMARY ISDN interface and 5 board status indicators are located on the front panel.

* the PRI board contains four switches (can be deactivated by jumpers) which makes hardware connection between PRI 1 and PRI 2 in case that system is switched off or has some software problem.

PWR LED	Indicates board supply
Lights on	Switched on
Lights off	Switched off
INIT LED	Indicates board initialization or error status
Blinks	Indicates the initialization of the board
Lights on (still)	Board initialization failure
LAY3 LED	indicates layer 3 status
Lights on	active call or channel restart
Lights off	No call through PRI ISDN
LAY2 LED	indicates layer 2 status
Lights on	Established
Lights off	Not established
Blinking	Not established
LAY1 LED	indicates layer 1 status
Lights on	synchronized
Lights off	Not synchronized (disconnected)
Blinking slowly	No frame synchronization
Blinking quickly	No multi-frame synchronization

3.3.2. Configuration Jumpers

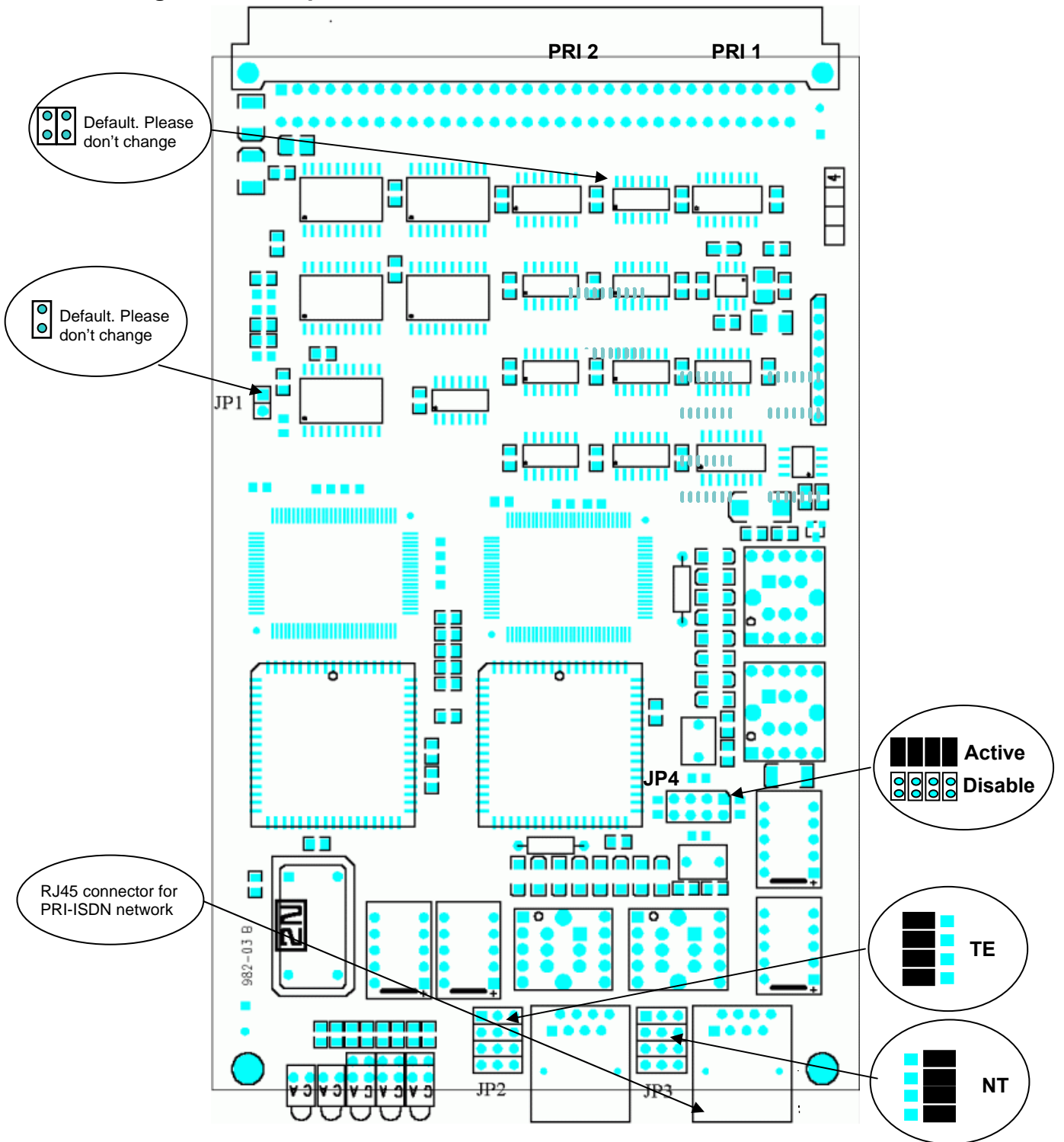

There are four configuration jumpers on the PRI board. Jumper JP1 is intended for a change of the board addressing and is not used at present. Jumpers JP2, JP3 is used for hardware switching of the PRI ISDN connector into the TE or NT configuration. This operation means only swapping of the transmitting and receiving connector pairs, the interface configuration must be made by software. With jumper JP4 you can activate/deactivate back-up connection between PRI1 and PRI2 in case that system is switched off or PRI board isn't handled by system . By default, jumpers JP1 is disconnected, jumper JP2 is connected as TE, jumper JP3 is connected as NT and JP4 is connected.

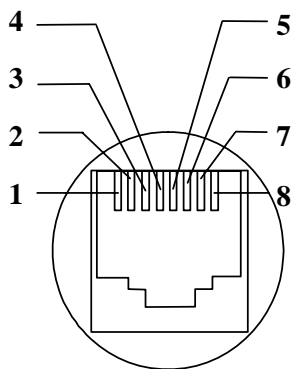

1 RX
2 RX
3 Not used
4 TX
5 TX
6 Not used
7 Not used
8 Not used

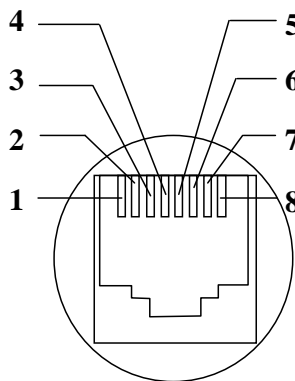

1 TX
2 TX
3 Not used
4 RX
5 RX
6 Not used
7 Not used
8 Not used

Fig.: contacts of TE connectors

Fig.: contacts of NT connectors

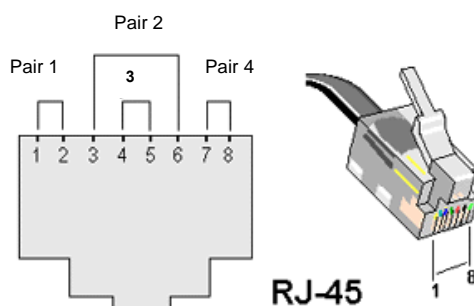

Best way how to connect PRIGW unit into your telecomm. site:



Connection with 2x PRI BOARD (connection to PSTN <-> PBX trunk):

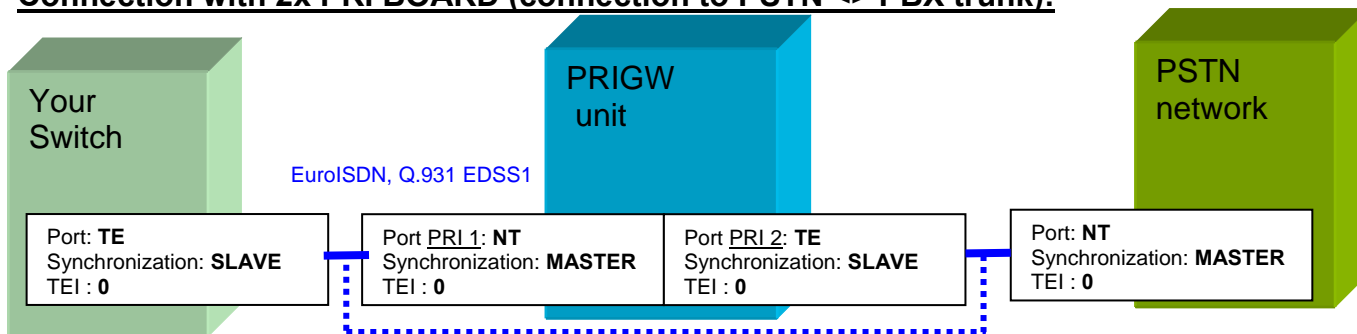

— Connection between two PRI equipments

••••• In case that system is switched off or has some SW problem (uploading firmware), switches on PRI board automatically disconnect PRIGW and makes direct connection between your switch and PSTN network.

* port mode (NT, TE) and Synchronization (MASTER, SLAVE) must be different on the switch than on the PRIGW! TEI management number must be same on both equipment units!

3.4. VoIP board

3.4.1. Board Description

The VoIP mainboard contains VoIP card with signaling processors and main control processor. On mainboard are is located 10/100BaseT Ethernet switch and processor for conversion of voice streams. The mainboard is designed on a 4-layer PCB of the size of 160x100mm. 5 board status indicators are located on the front panel.

Possible statuses of indication LED diodes (units with firmware 02.09.xx and higher):

PWR LED	Indicates board supply
Lights on	Switched on
Lights off	Switched off
Blinking	Board in sleep mode
INIT LED	Indicates board initialization or error status
Blinking	Indicates the initialization of the desk
Lights on (still)	Board initialization failure
Lay 2 LED	Not implemented
Lay 3 LED	Not implemented

VoIP board is configurable by web interface (see chapter VoIP board configuration). Signalization packets (SIP) must be routed to IP address of CPU, voice stream (RTP packets) to IP address of VoIP board !

3.5. Thin VoIP board

3.5.1. Board Description

New "thin" variant of VoIP card for StarGate*, BlueStar* and BlueTower systems. VoIP board contains digital signaling processor, license chip. There is also located 10/100BaseT Ethernet switch. The mainboard is designed on a 4-layer PCB of the size of 160x100mm. 5 board status indicators are located on the front panel. Configuration of this type of VoIP board is completely via standart configuration tool.

Possible statuses of indication LED diodes (units with firmware 02.09.xx and higher):

PWR LED	Indicates board supply
Lights on	Switched on
Lights off	Switched off
Blinking	Board in sleep mode
INIT LED	Indicates board initialization or error status
Blinking	Indicates the initialization of the desk
Lights on (still)*	Board initialization failure

Signalization packets (SIP) must be routed to IP address of CPU, voice stream (RTP packets) to IP address of VoIP board !

*Normal initialization of the board is about 1 minute from start of whole system.

3.6. GSM board

3.6.1. Board Description

- In PRIGW you can use seven types of GSM boards (with various GSM modules):
 - GSM board with two modules Sony-Ericsson GM22 and two SIM holders.
 - GSM board with two modules Sony-Ericsson GM47 and two SIM holders.
 - GSM board with two modules Sony-Ericsson GM48 and two SIM holders.
 - GSM board with two modules Siemens TC35i and eight SIM holders.
 - GSM board with two modules Siemens TC35i and sixteen SIM holders
 - GSM board with two modules Siemens MC55i and eight SIM holders.
 - GSM board with two modules Siemens MC55i and sixteen SIM holders.
 - GSM board with two modules Wavecom Q24CLA and eight SIM holders.
 - GSM board with two modules Wavecom Q24CLA and sixteen SIM holders.
 - 3G board with two modules SierraWireless MC8775V and eight SIM holders.

The GSM board contains two GSM modules, circuits for their connection to the PCM bus, and DTMF receivers. The board is designed on a 4-layer PCB of the size of 160x100mm. Pins 1 and 32 are approximately 1 mm longer in the GSM board system connector and are used for "hot swap" power feeding, allowing to push the board in and out even during operation. This feature is handy especially for installation or SIM card replacement. Two FME antenna connectors (for GSM boards with modules GM22) or two SMA antenna connectors (for GSM boards with modules TC35 and MC45(6)) and 5 board status indicators are located on the front panel.

Possible statuses of indication LED diodes (units with firmware 02.09.xx and higher):

PWR LED	Indicates board supply
Lights on	Switched on
Lights off	Switched off
Blinking	Board in sleep mode
INIT LED	Indicates board initialization or error status
Blinking	Indicates the initialization of the desk
Lights on (still)	Board initialization failure
SLP LED	Both GSM modules are manually switched off
GSM1 LED	indicates GSM 1 module status
GSM2 LED	indicates GSM 2 module status
Lights on	Proceeding call
Lights off	Unused GSM module
Blinking slowly	Module is terminating of call (2 seconds)
Blinking quickly	Log in GSM network / initialization of SIM card
GSM1 LED	indicates GSM 1 module status
GSM2 LED	indicates GSM 2 module status
Lights on	GSM module is blocked or initializing
Blinking quickly	GSM module is powered off

3.6.2. Configuration Jumpers

3.6.2.1 GSM board with 4SIM cards per GSM module

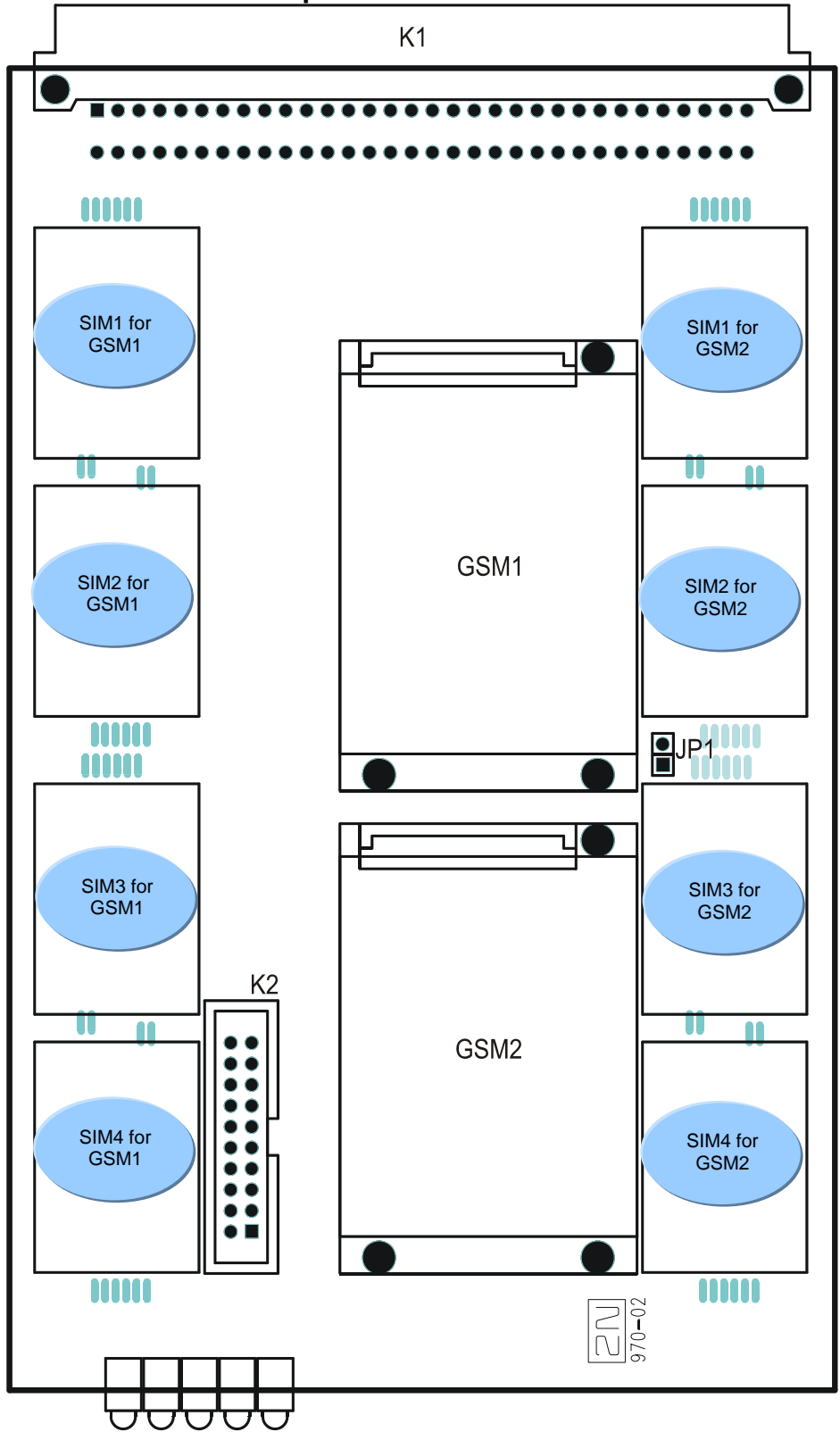

There is just one configuration jumper on the GSM board. Jumper JP1 is intended for a change of the board addressing and is not applied at present. Connector K2 is designed for servicing purposes only and may not be connected. Jumper JP1 is disconnected by default.

3.6.2.2 GSM board with 8SIM cards per GSM module

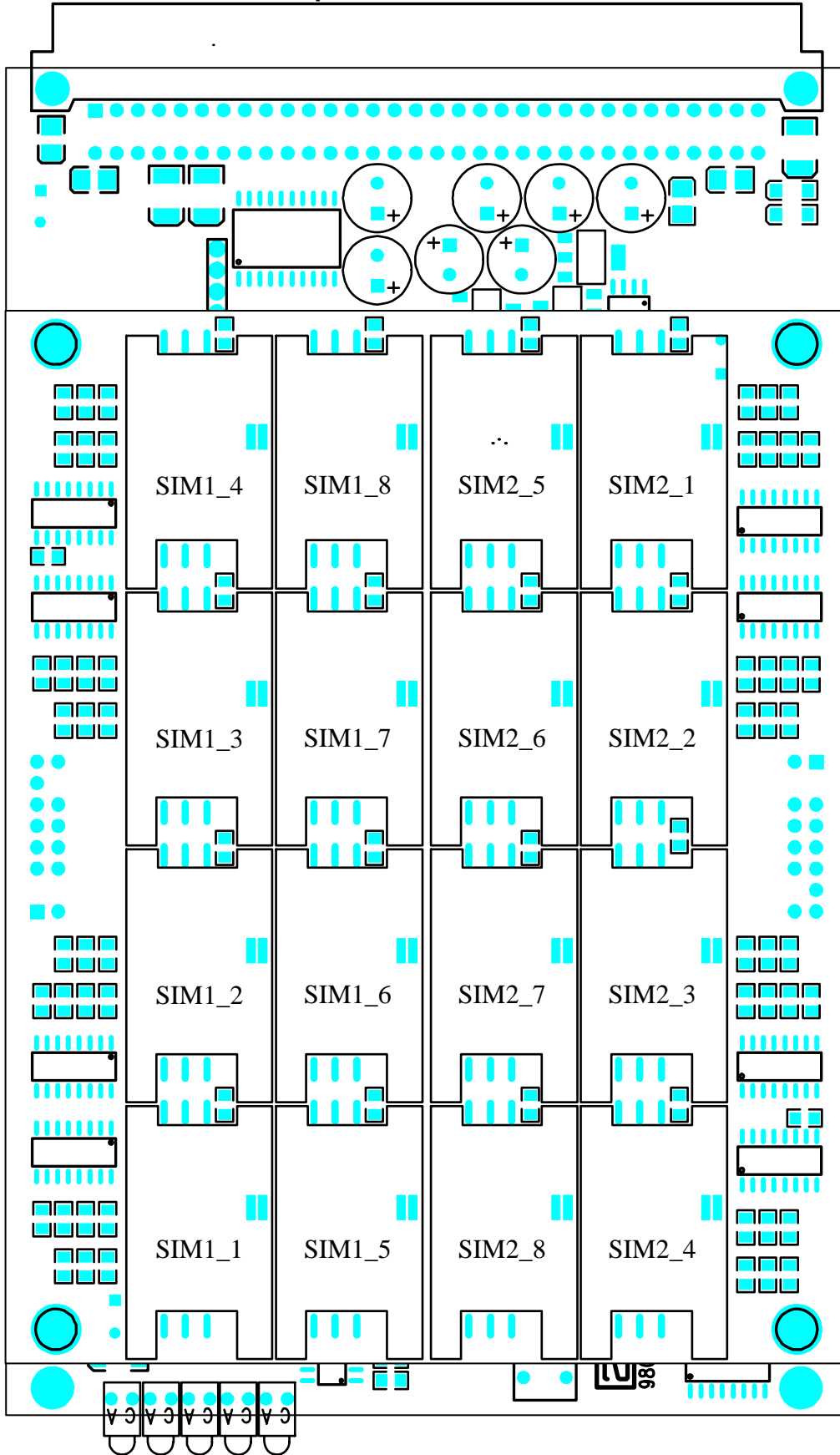

3.8. 3G Two channel card

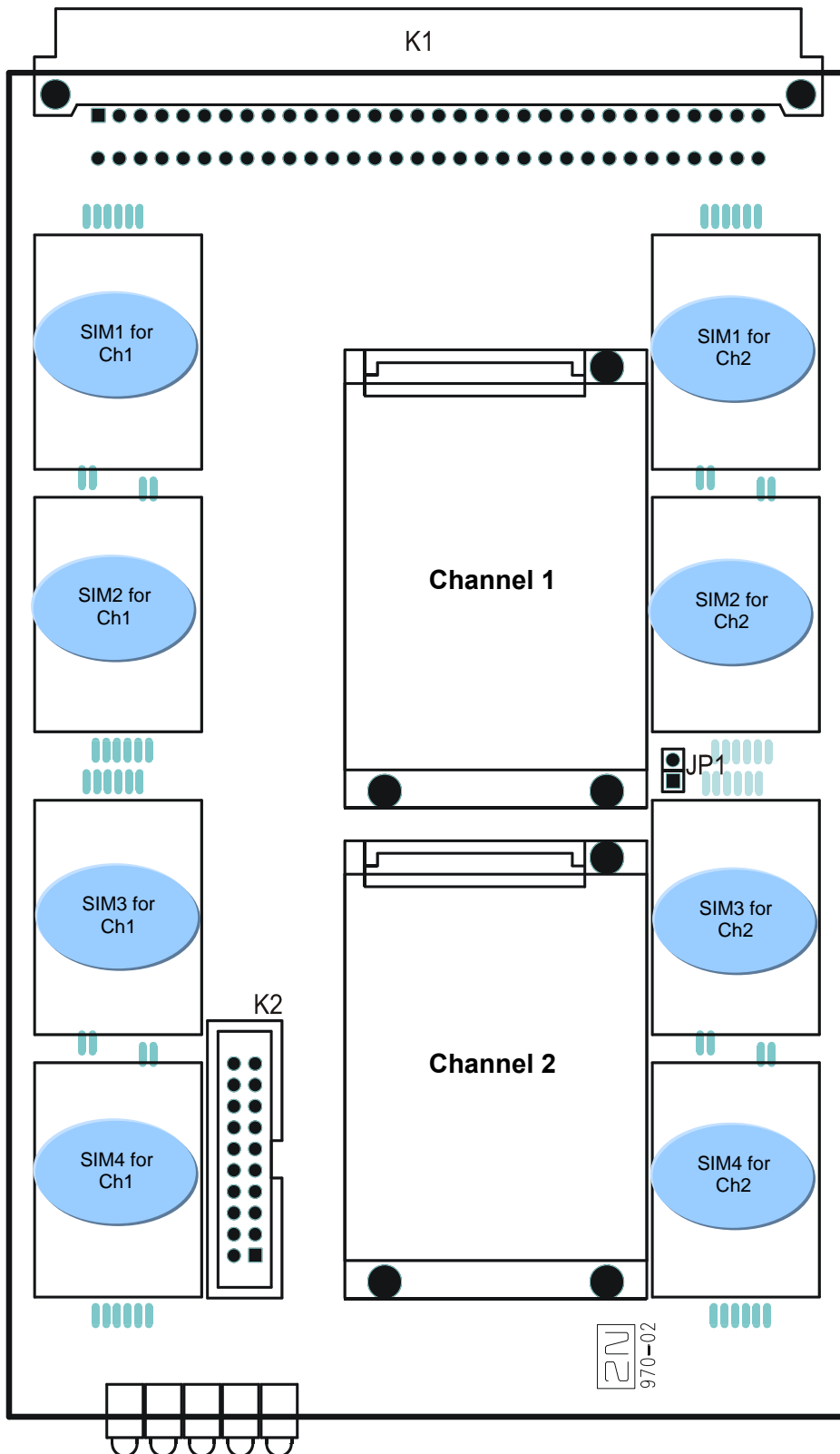

4. Antenna Splitter

4.1. Splitter description



Internal Antenna Splitter for BlueStar



Internal Antenna Splitter for BlueTower



External Antenna Splitter for StarGate

Antenna splitter is the passive unit suitable for GSM gateways. It can combine maximum 16 antenna inputs to one 1 antenna output. Antenna splitter saves antenna cable, number of outdoor antennas and mounting space on the roof.

As a passive unit it inserts the loss between antenna and the equipment. Splitter configuration depends on signal level at concrete placing and number of using directions or GSM providers. Splitter can be external (StarGate) or internal (BlueStar, BlueTower)

- four inputs and one output splitter block
- two inputs and one output splitter block

4.1.1. Standard configurations of external antenna splitter

NUMBER OF INPUTS	NUMBER OF OUTPUTS	INPUT – OUTPUT INSERTION LOSS	UNIT HIGH
32	2	< 15 dB	2U
32	4	< 11 dB	2U
32	8	< 8 dB	2U
16	1	< 15 dB	1U
16	2	< 11 dB	1U
16	4	< 8 dB	1U
12	3	< 8 dB	1U

4.1.2. Standard configuration of internal antenna splitter of 3G Extension rack

NUMBER OF INPUTS	NUMBER OF OUTPUTS	INPUT – OUTPUT INSERTION LOSS	UNIT HIGH
32	2	< 15 dB	6U

4.1.3. Standard configuration of internal antenna splitter for BlueStar

NUMBER OF INPUTS	NUMBER OF OUTPUTS
16	2
16	1
8	2
8	1

4.1.4. Standard configuration of internal antenna splitter for BlueTower

NUMBER OF INPUTS	NUMBER OF OUTPUTS
4	1

4.1.5. Technical parameters of antenna splitters

Parameters	Value	Notice
Connector type		
Input connector	SMA type, female	
Output antenna connector	N type, female	
RF parameters		
Impedance	50 OHM	
Frequency	850 – 1900 MHz	
Insertion loss	< 8, 11, 15 dB	According configuration
Isolation between two channels	> 20 dB	
Output over voltage protection		
Device type	Gas protector	
Protected voltage level	90 V	
Peak current	10 KA	
Insertion loss	0.2 dB	

To minimize signal loss, use the dummy load on the free (not used) connectors of the antenna combiner. If you have not received the dummy loads together with the SMA connector, you can order them separately.

Results of measurement with and without „dummy load“:

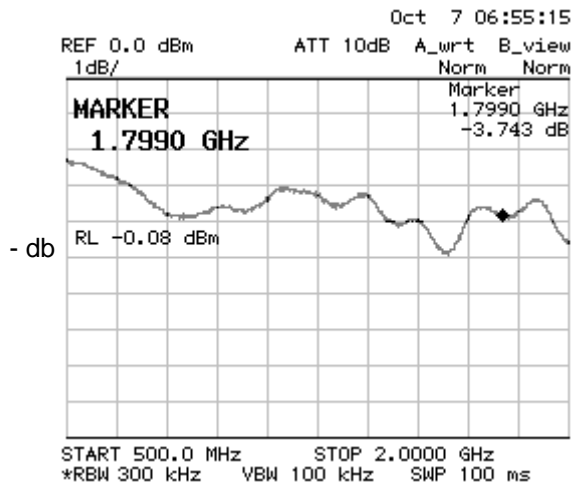

Without dummy load

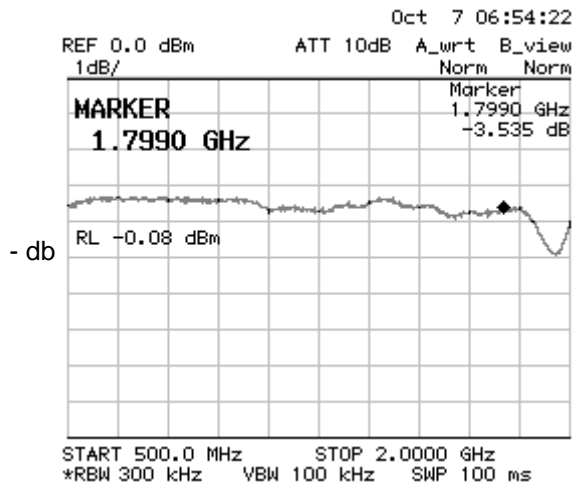

With dummy load

5. Directional GSM Antenna

Directional antenna basic parameters:

Type	CPY 9214
Number of elements	14
Frequency	824 – 896, 1770 – 1880 MHz
Gain	9.5 dB / 13 dB
Cable	RG 58, 10m
V.S.W.R	< 1.5 : 1
Connector	N type, male

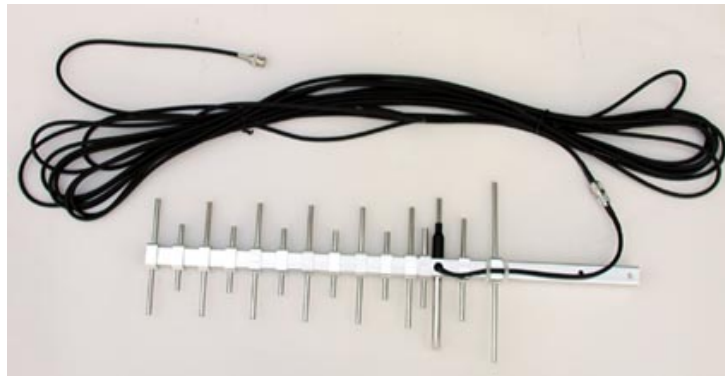

Directional antenna



Fig.:The example of the right installation of directional antennas



Warning:
The antenna has to be placed according to safety rules of overvoltage protection and grounding.

6. Discreet Antenna

Discreet antenna basic parameters:

Type	Car antenna
Gain	3dB
Cable	Coax cable 174A (5 m)
Connector	SMA (male)



Discreet antenna

7. Installation

7.1. Firmware version and license

Before installation of your PRIGW Gateway please make upload of new FW to the gateway. Actual version of the firmware + all software you find on enclosed CD, or on our website www.2N.cz .

FIRMWARE uploading procedure (by local serial port):

- Connect your PC to PRIGW (COM1) via RS232 (serial port).
- Prepare the firmware-containing file into a folder selected by you (*Pxxxx-V-xx.xx.xx.hex*).
- Run PRIGW program
- In the section "Gateway control" choose item "Firmware/Licence"
- Choose file in "Firmware file" containing new firmware (*Pxxxx-V-xx.xx.xx.hex*)
- Click on button "Upgrade firmware trough COM".
- The program now automatically uploads your new firmware (it's takes about 2 minutes)
 - the gateway is reset during this procedure (thus discontinues all current calls and SMS). Do not interrupt the program during this procedure to avoid errors in firmware uploading – otherwise the gateway might stop working!

If procedure of uploading firmware was terminated, please make cool reset of the gateway and re-load PRIGW program and try to upload firmware again.

FIRMWARE uploading procedure (remotely by ethernet)*:

- Run PRIGW program
- In section "Gateway control" choose item "Firmware/Licence"
- Choose file in "Firmware file" containing new firmware (*Pxxxx-V-xx.xx.xx.hex*)
- Click on button "Upgrade firmware trough Ethernet".
- The program now automatically uploads your new firmware (it's takes about 30 seconds)
 - the gateway is reset during this procedure (thus discontinues all current calls and SMS). Do not interrupt the program during this procedure to avoid errors in firmware uploading – otherwise the gateway might stop working!

*for successful firmware upgrade trough Ethernet you have to :

- grant remote upgrade in configuration of the gateway.
- gateway must contains bootware v02.52 or higher and firmware v02.30.01 or higher
- gateway (CPU) must be connected to Ethernet network.

Firmware license:

The gateway's firmware is from factory limited for **850 hour*** (c. 35 days, every reset of gateway will add one hour !). After this time the gateway will block the Layer 3 (signalization layer) on the PRI interfaces !!!

Actual status of limit you can see in status line of connected PRIGW program.

Please contact 2N sales before end of this period. We will send to you new licence key string for unlock licence limitation of the firmware.

How to add new licence:

- Connect your PC to PRIGW via RS232, ISDN DATA, TCP/IP
- Make cool reset of the gateway

- Run PRIGW program
- In the menu „Gateway control“ choose item „Set keylock“
- Insert correct unlock key (bad unlock key will make block of the gateway!!)
- Wait for restart of gateway
- In status line of PRIGW program you can check actual status of firmware limitation.

7.2. GSM network limitation

GSM boards of your PRIGW can be locked for using only in some GSM networks or there can be restriction for log-in to some GSM network. Information about this lock you find on PRIGW package. This limitation is always provided by customer request.

7.3. Installation Conditions

The following conditions must be met during system installation:

- appropriate location (enough free space);
- GSM signal intensity (minimum signal level: **-80db**). As GSM signal intensity meter you can use NET monitor on some mobile phone (e.g. Nokia, Siemens)
- un-overloadable GSM cells into which GSM gate modules are logged (please keep in mind that full traffic will make up to 30 calls in one time (according of configuration of the gateway)!
- no strong electromagnetic radiation on the system installation site;
- no strong reflections in antennas installation place
- the ISDN PRI connection must be configured properly and meet ITU-T Q.931-EDSS1 and related recommendations.

7.4. Potential GSM Network Problems

The PRIGW works reliably even under a 100% load. The following problems may be caused by GSM networks:

1. The GSM modules cannot log in, log in slowly or log out occasionally. This problem can have two causes:
 - The GSM signal level is low – the recommended minimum signal level is approximately **-80dB**, if lower, the GSM antenna location must be changed.
 - The GSM cell into which the modules try to log is overloaded – if you use directional antennas, you can direct them to more GSM cells than one. The possibility to choose a cell by directing your antenna is considerably limited or eliminated in municipal or densely populated areas where multiple signal reflections occur. It is also difficult to select a cell where the cells lie in a straight line before and behind the antenna. If no selection can be made, you have to use another available GSM provider. **CAUTION!** You are recommended to use 32 channels at most on one installation site for one GSM provider to avoid GSM network overload problems on the installation site.
2. One of the GSM modules is permanently logged-out or fails to receive incoming calls – this problem indicates a GSM network overload due to heavy traffic. You can eliminate this problem by the above mentioned solutions or extend the “relaxing time“ – i.e. the delay between two calls via one GSM module (the recommended value is 2 seconds). In case any of the GSM modules cannot log in the network even after reset, your GSM provider may have located the SIM card but refused to log it in the network because either too many calls are made using this card, or the SIM card keeps logged in the same GSM cell and the same GSM module for too long. This problem can be solved by occasional replacement of SIM cards between modules.

7.5. Main Installation

- Place the gateway into an environment that corresponds with its working conditions.
- Configure the gateway properly using the configuration software included.
- The gateway mains supply must be backed-up and overvoltage protected (recommended is line-interactive or on-line UPS).
- For a more comfortable gateway administration, it is advisable to have one of available remote control tools on site (ISDN line, analog line, Ethernet).

7.5.1. Control Ways

The system can be supervised and controlled locally or remotely as follows:

- A. Local control using a PC connected by a standard full crossed serial cable .
- B. Remote control using an analog or ISDN modem connected to the PRIGW COM2 (the modem initialization commands have to be selected correctly – refer to PRIGW configuration>PRIGW program). For connection between modem and the gateway please use full straight serial RS232 cable.
- C. Remote control over the IP network using a standard Telnet protocol. Here, be sure to set the IP address and IP mask properly – refer to system configuration>PRIGW program).
- D. Remote control via B-channel of PRI connection**

***This way is optional (needs additional chipset on AUX board)*

7.5.2. Configuration Ways

The system can be configured by any of the following two ways:

- A. using extended AT commands (refer to Appendix A);
- B. using the PRIGW program..

A PC can be used for both the ways, either locally (via a serial cable), or remotely with a modem, using the Telnet protocol over IP, or via B-channel.

Since the PRIGW is constantly upgraded, you are advised to use the latest PRIGW software firmware versions.

7.5.3. Your first installation (quick step by step guide)

- 1/ Connect the gateway with PC via RS232 cable
- 2/ Install&Run from attached CD the PRIGW program
- 3/ In top menu open parameter SETTINGS, COMMUNICATION SETTINGS and select right COM port where is the PRIGW connected (description on page 60 section 9.5)
- 4/ Section GATEWAY CONFIGURATION, SYSTEM PARAMETERS (description on page 63 section 9.7.3.1)

- add IP address and IP mask of the PRIGW (In case that you want to make remote control via IP)
- Set PIN code (for case that you have on SIM cards enabled PIN code)
- **!!! WARNING – IN CASE THAT YOU HAVE SIM CARD WITH ENABLED PIN - ALL SIM CARDS MUST HAVE SAME PIN CODE AS PIN CODE DEFINED IN PRIGW !!!**
- Set parameter GENERAL SELECTION OF SIM CARDS to “According to GSM groups”

5/ Section GATEWAY CONFIGURATION, ISDN PARAMETERS (description on page **Chyba! Záložka není definována.**, section **Chyba! Nenalezen zdroj odkazů.**)

- Set right setting of PRI ISDN interfaces. Details about installation settings you also find on page 17 section 3.3. In case that layers 1 and 2 on PRI interface are not

established, please recheck the right configuration of PRIGW and your router/PBX. For actual status of PRI interface please open item in top menu Gateway Control, Diagnostics and select PRI.

Description of this window you find on pages 53, section 9.4.3.

6/ Section GATEWAY CONFIGURATION, GSM GROUPS ASSIGNMENT (description on page 71, section 9.7.4.2)

- Divide the GSM modules (cards) to outgoing and incoming GSM groups according to you installation requirements

7/ Section GATEWAY CONFIGURATION, GSM OUTGOING GROUPS (description on page 72 section 9.7.4.3)

- for first start select parameter Mode of switching SIM card and last searched SIM to SIM1 for each GSM group which you are using

8/ Section GATEWAY CONFIGURATION, PREFIXES (description on page **Chyba! Záložka není definována.** section **Chyba! Nenalezen zdroj odkazů.**)

- in case that you using more GSM operator please make delete of all eight Prefix lists and add to Prefix list 1 prefixes for GSM operator 1, to Network list 2 for GSM operator 2 etc... Please don't remember to add also right length of dialed number for each prefix.

9/ Section GATEWAY CONFIGURATION, LCR TABLE (description on page 78 section 9.7.5)

- here you have possibility set in which time which prefixes (saved in prefix lists) will be routed to which GSM group. You can select more GSM groups in one line – gateway will try use second GSM group in case that first GSM group is not available or busy. Also you can set more tries for one GSM group > for increase ASR...

10/ In top menu in GATEWAY CONTROL, open item DATE/TIME for set right time and date in the gateway

11/ In top menu in GATEWAY CONTROL, open item LOGIN ACCOUNT to change access rights for remote control via Telnet or PRI ISDN

12/ Save the configuration to PRIGW

13/ Plug-in the SIM cards and connect antennas and make restart of the gateway.

In case that you have problem with right function please read carefully this manual, check all parameters. Also you can contact us by e-mail techsupport@2n.cz. To email please write detail description of problem and also attach the configuration file of the gateway (unnamed.ini)

7.6. Configuration of 12 HP VoIP board

7.6.1. Main description of VoIP board

The VoIP board is designed to process the voice flow from a VoIP environment. The CPU of the GSM gateway is responsible for signalling (SIP). Therefore, it is necessary to set the signalling and voice parts separately. To do this, use the StarGate / BlueStar program for signalling and the web interface for voice.

Each of the two parts has an IP address of its own (see the default settings below) and so it is necessary to interconnect the CPU and VoIP board during installation with a patch cable included in the delivery.

7.6.2. Default Settings

Parametr	Hodnota
IP address of CPU	192.168.1.100
IP mask of CPU	255.255.255.0
Username/password of CPU	2n/2n
IP address of VoIP board	192.168.1.101
IP mask of VoIP board	255.255.255.0
Username of VoIP board	Admin
Password of VoIP board	Admin

7.6.3. VoIP Board Configuration (Web Interface)

While configuring the system using the web interface keep the default values of the following parameters.

Quick Setup	
IP Configuration	
IP Address	10.1.10.10
Subnet Mask	255.255.255.0
Default Gateway Address	0.0.0.0
DNS Primary Server IP	0.0.0.0
DNS Secondary Server IP	0.0.0.0
Enable DHCP	Disable
Trunk Configuration	
Protocol Type	E1 TRANSPARENT 30
Clock Master	Recovered
Framing Method	Super Frame
Line Code	HDB3
Control Protocol Configuration	
Control Protocol Type	MGCP
Call Agent IP	10.1.10.15
Call Agent Port	5060
Call Agent Domain Name	
Gateway Name	2N
Endpoint Prefix	
Trunk Name	

Trunk configuration:

Protocol type = **E1 TRANSPARENT 30**

Clock master = **Recovered**

Framing method = **SUPERFRAME**

Line code = **HDB3**

Control protocol configuration:

Control protocol type = **MGCP**

Call agent IP = IP address of CPU card (default 10.1.10.15)

Call agent port = **5060**

Profile = **NORMAL**

!!! PLEASE MAKE CHANGE ONLY IP CONFIGURATION PARAMETERS AND CALL AGENT IP ADDRESS. CHANGING THE OTHERS PARAMETERS MAY CAUSE BAD FUNCTION OF THE VOIP BOARD !!!

7.6.4 VoIP Board Firmware Upgrade

Refer to www.2n.cz for the latest VoIP board firmware version. If you find a version later than yours, please upgrade your VoIP board as follows:

- open your web browser and type IP address of VoIP board
- enter right username and password for access
- select item „Software Update – Software upgrate wizard“

!!! PLEASE USE ONLY FIRMWARE FILE WHICH YOU RECEIVE FROM 2N, DIFFERENT FIRMWARE FILE MAY CAUSE WRONG FUNCTION OF VOIP BOARD !!!

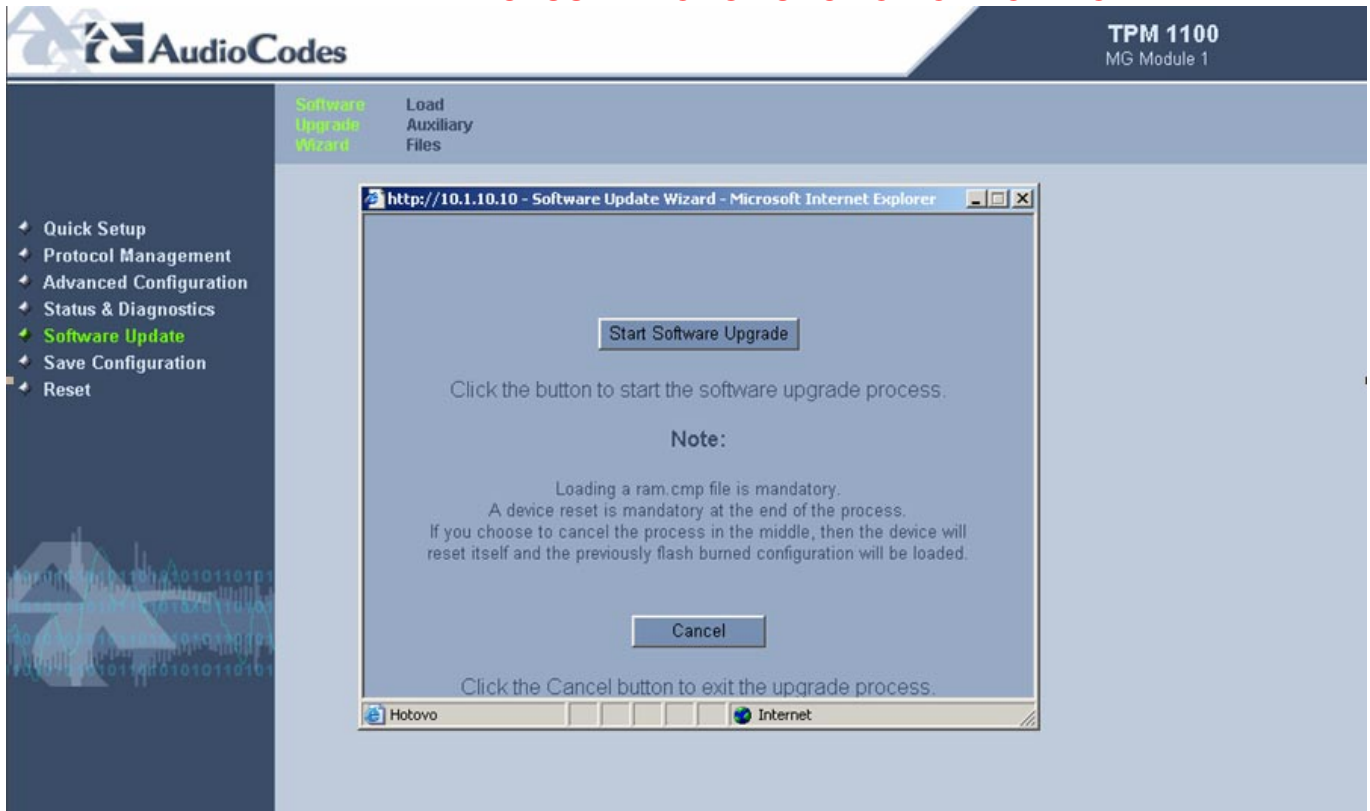

- click to „Start Software Upgrade and find file which contains new firmware:

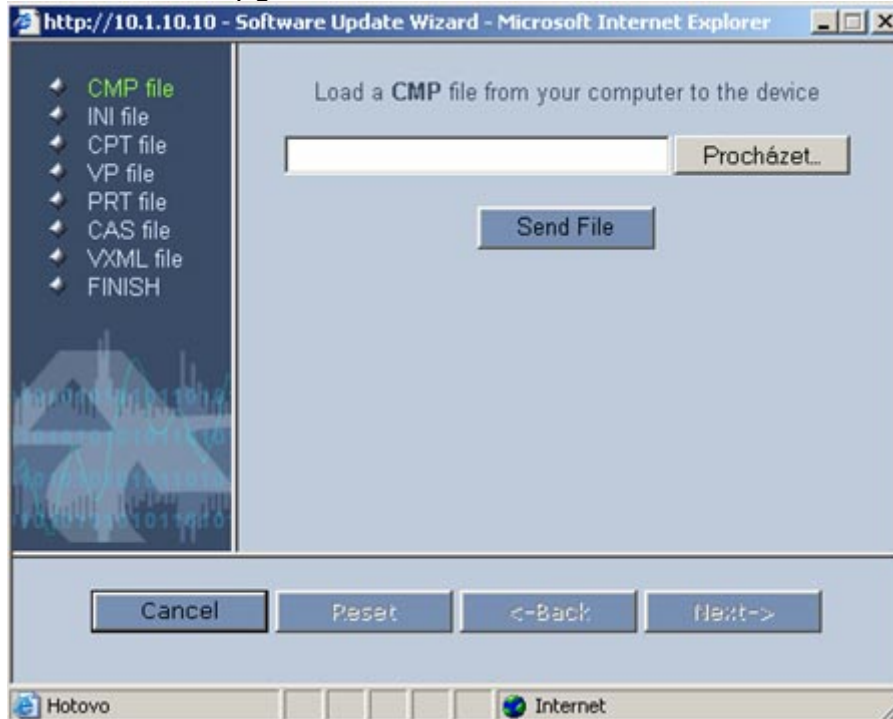

- the file will be automatically loaded to RAM of the VoIP board:

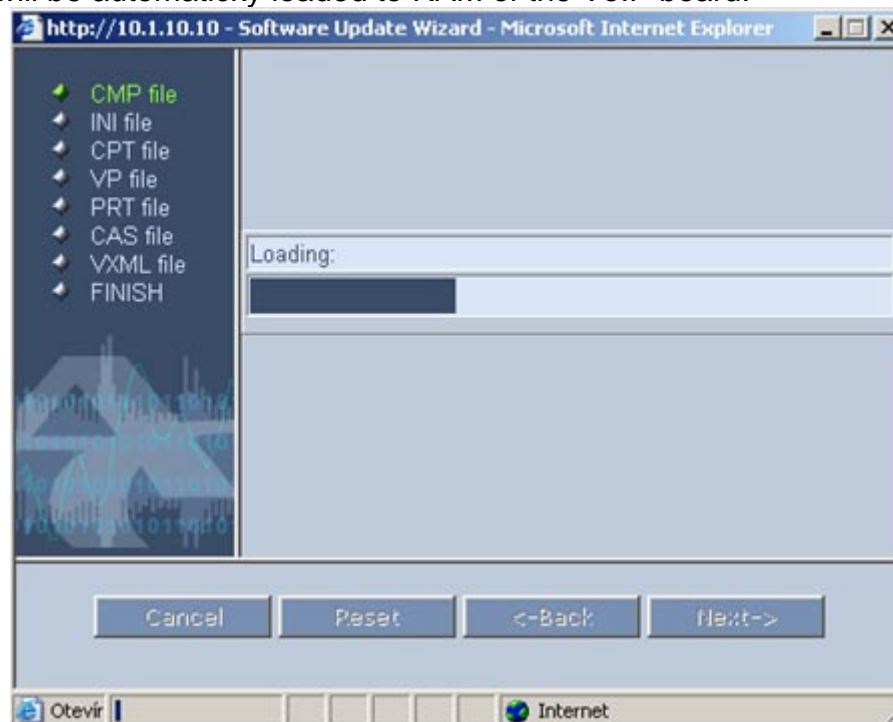

- After successful upload of the file you will receive following information. Now please click to button „Next“.

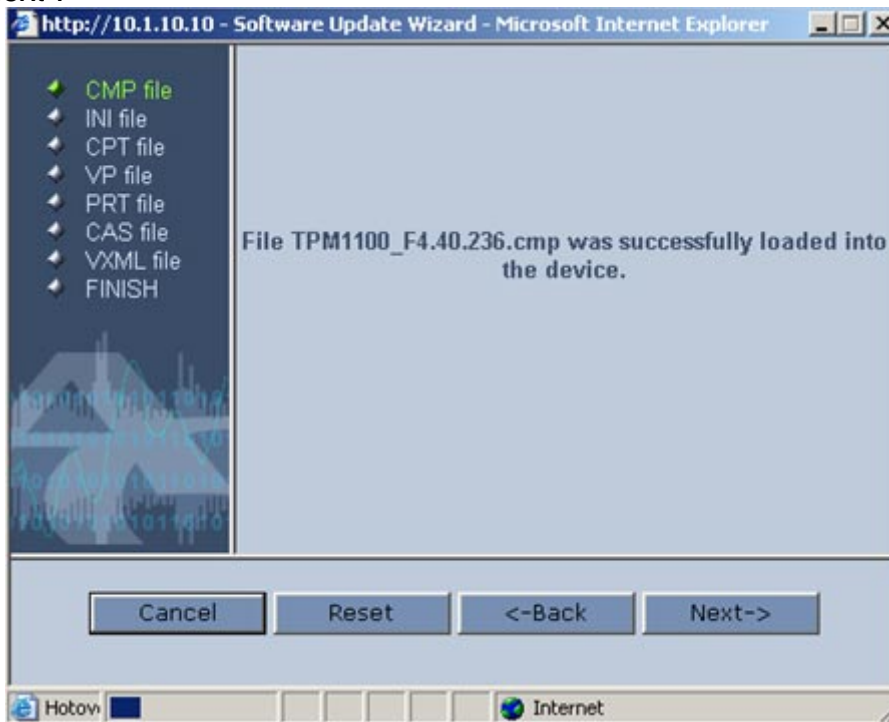

- When you will receive file following text, please click to buton „Reset“.

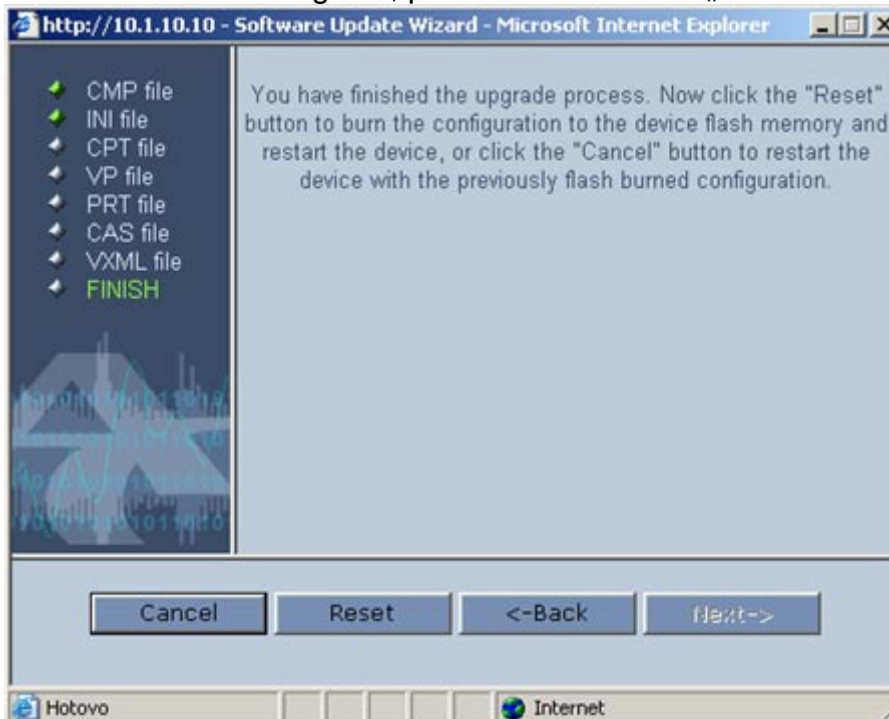

- After it, the system will save new firmware fo EEPROM memory and makes restart

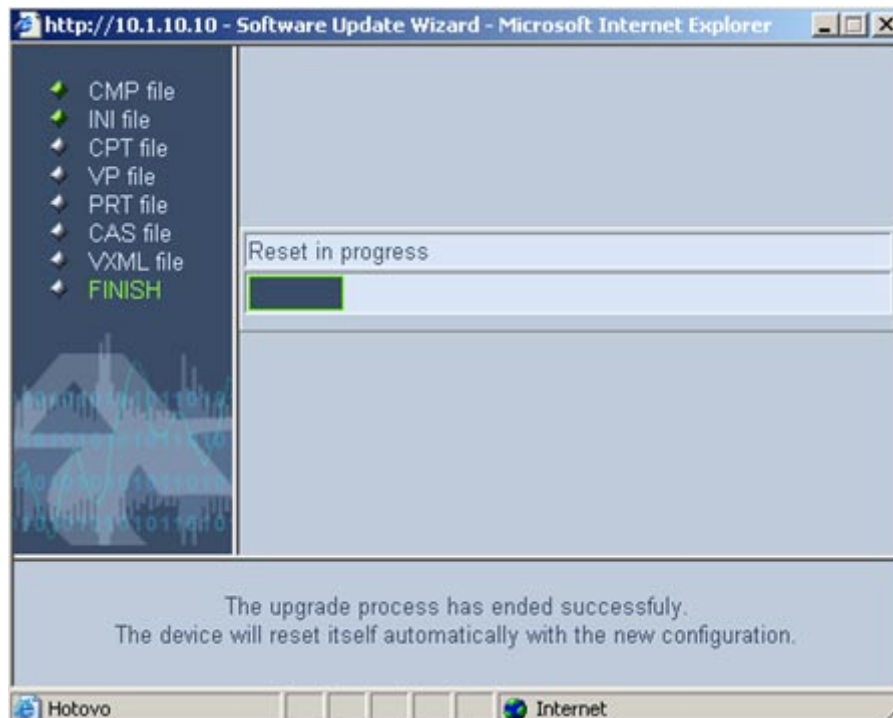
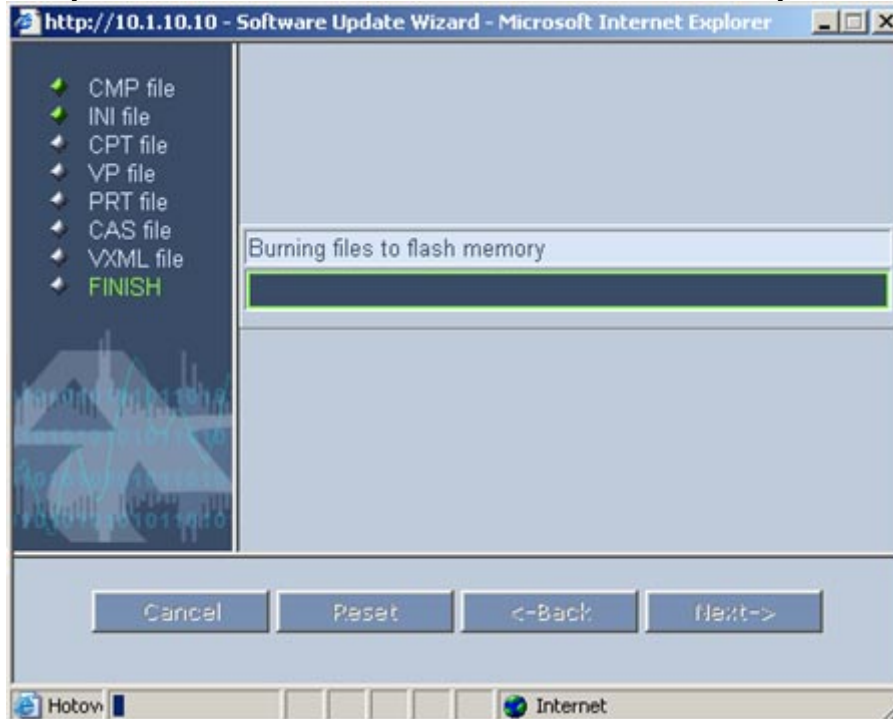

- Now the version of firmware of VoIP board is upgraded.

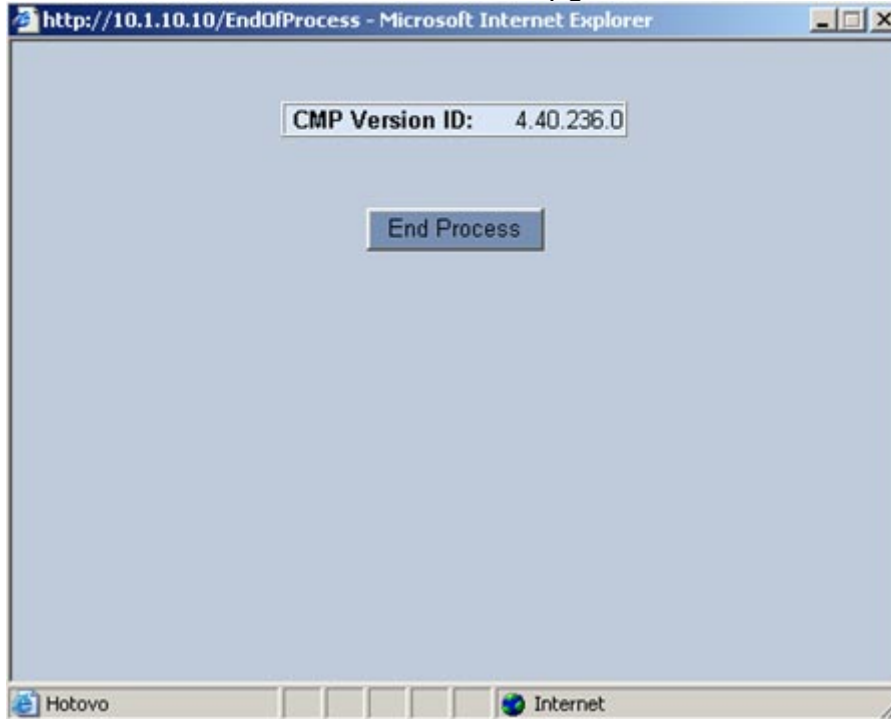

7.7. Configuration of 8HP VoIP board

The VoIP card is completely configured by PRIGW program through CPU card of the gateway. After any change in configuration of the VoIP card is complete system restart needed.

8. Configuration of Voice Callback Center software

This software is optional part of system. For additional information please contact 2N sales.

8.1. Scheme of function of Voice Callback

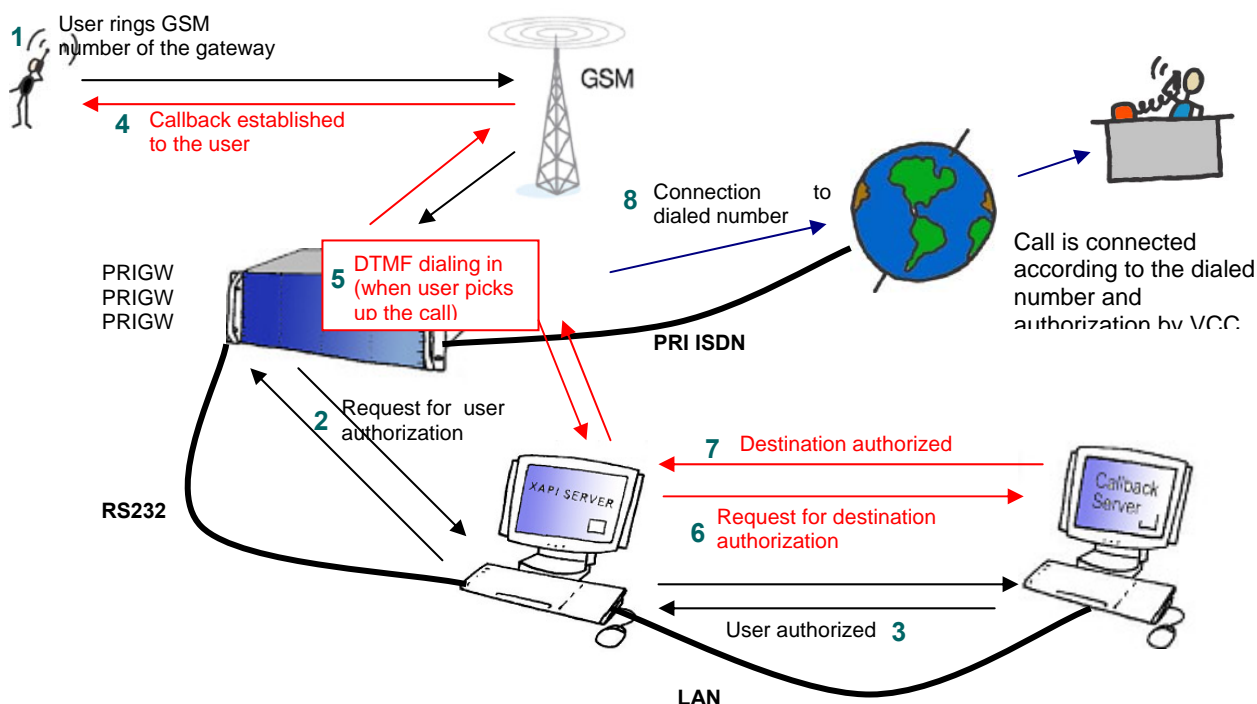

8.2. Installation and licenses

8.2.1. Communication settings of XAPI server

From attached CD, please run the file SETUP.EXE to launch the installation of XAPI server software. After successful installation, please run it.

As a first thing, you have to setup the connection between your PRI ISDN GATEWAY and PC (XAPI server).

Close all windows, except main XAPI server window. In main menu click to "Set" and "Module-PBX". In PBX settings you have to disable COM port by selecting "---" and click OK.

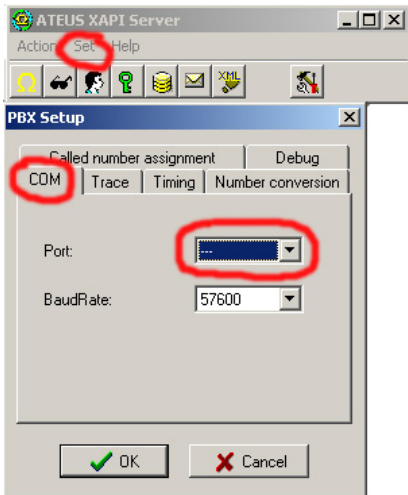

Now, you have to set the COM port, where your PRI ISDN GATEWAY is connected (for Voice callback service, serial connection is recommended!).

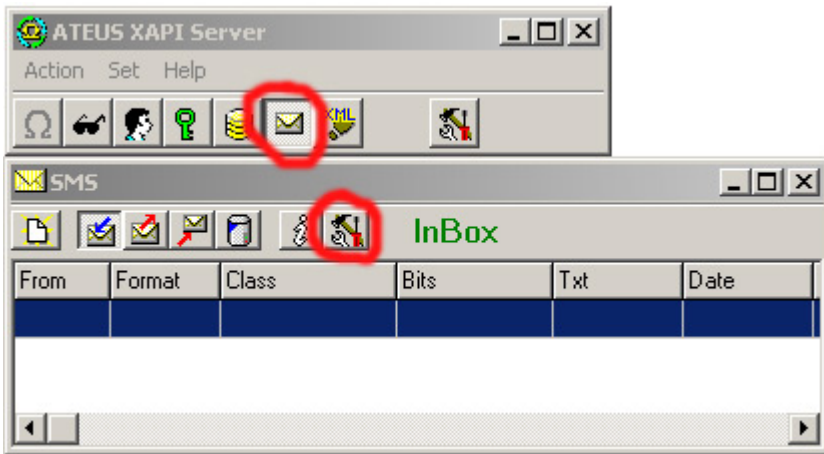

On the following picture you can see an example of correct connection settings for PRI ISDN gateway with external Voice Callback:

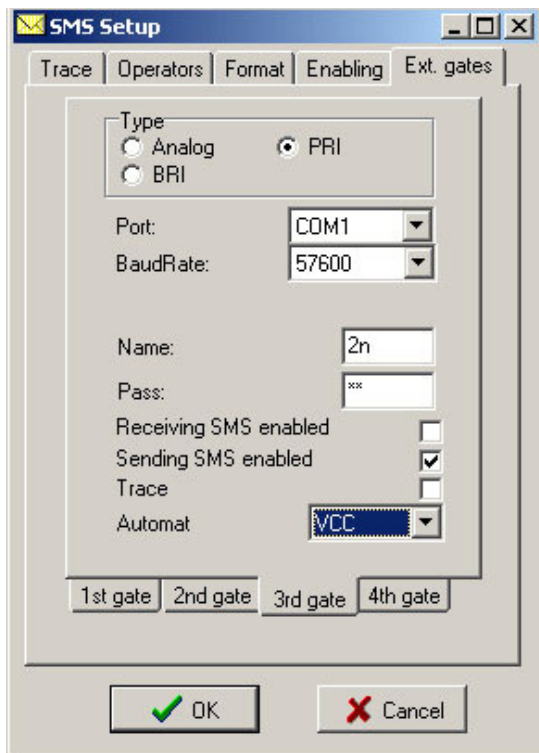

In case, that you set all parameters correctly, you will see signal status of GSM modules in status gateway window.

8.2.2. Licenses in 2N XAPI server

To activate Voice Callback center, you have to enter a valid license code to XAPI server. This license is generated by 2N according to requested service and serial number of CPU card in your PRI ISDN gateway. The license contains two codes, which you have to enter. Following picture shows how to add new license:

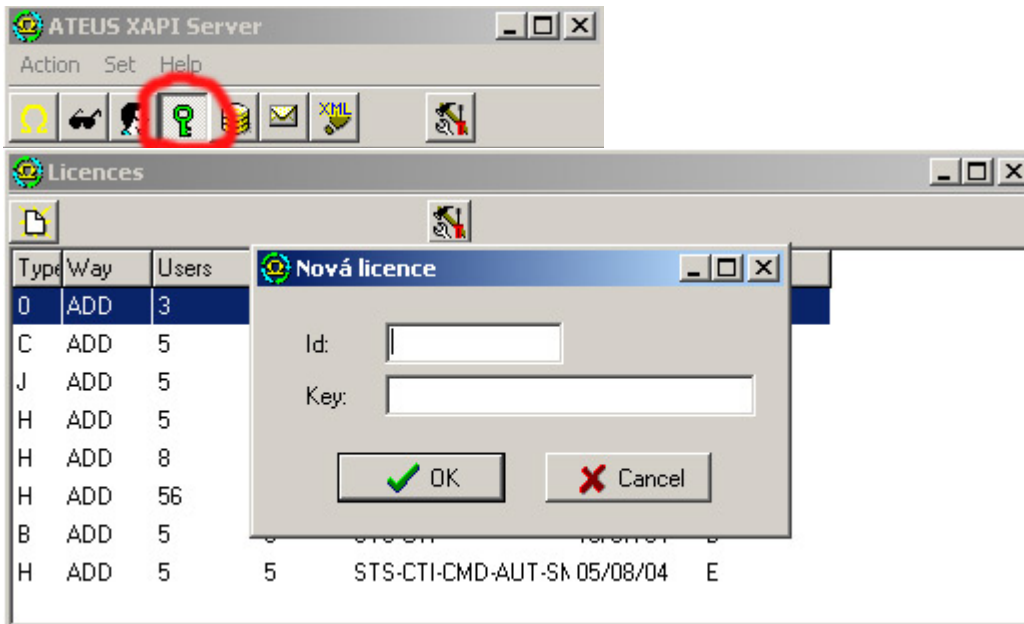

You have to create a new user, which will be used for communication between the Voice Callback Center and XAPI server.

Warning: In case, that you have not connected the PRI ISDN gateway, you will not succeed with adding of license to XAPI server (response will be: BAD LICENCE!) !!!

Creating of new user is very similar to adding of new license. Please follow the next pictures:



Click the USER icon to open window with all active users. In the next window "Users", click the second icon from left and then the icon for new user.

In USER window select the correct "firm" and activate attributes "SMR", add a name and a password of new user. This username and password must be put to into Voice callback center.

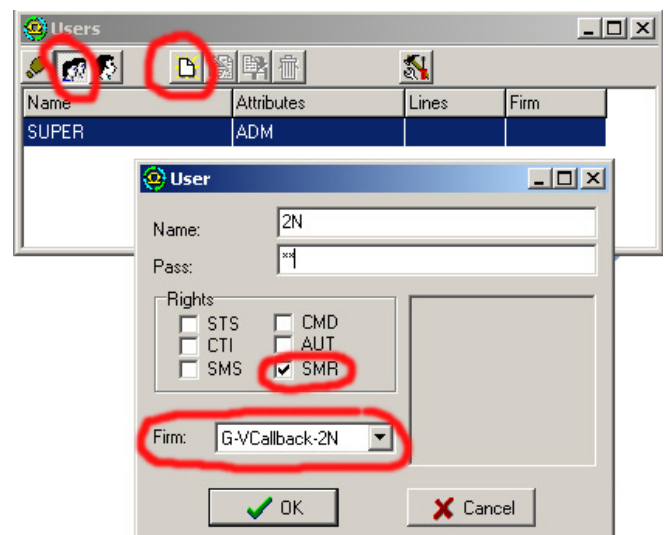

8.2.3. Connection settings of Voice Callback Center

After successful installation of Voice Callback center software you have to set the communication with XAPI server. As shown on the picture below, you have to set username and password (the same user account as in XAPI server) and IP address of PC, where the XAPI server runs. In case that XAPI server runs on the same PC you should add IP address of local host (127.0.0.1).

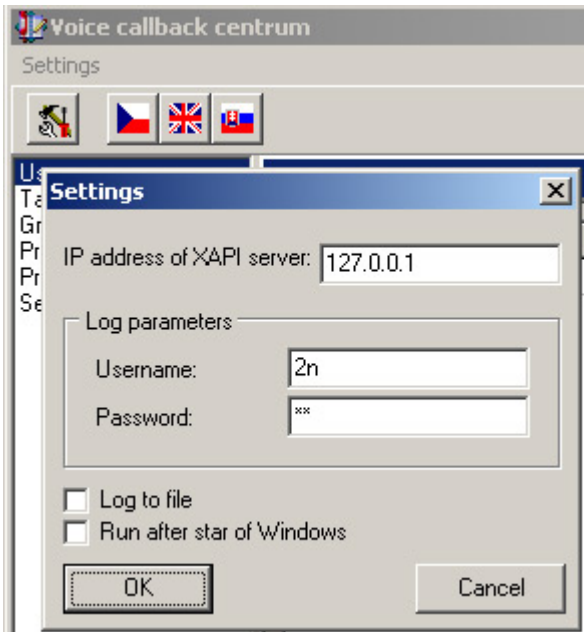

In case that the XAPI server is correctly configured and access parameters are properly set, the Voice Callback center software will automatically establish connection with XAPI server. You may check that also in the LOG of Voice Callback Center where you may see parameters of connection and type of license.

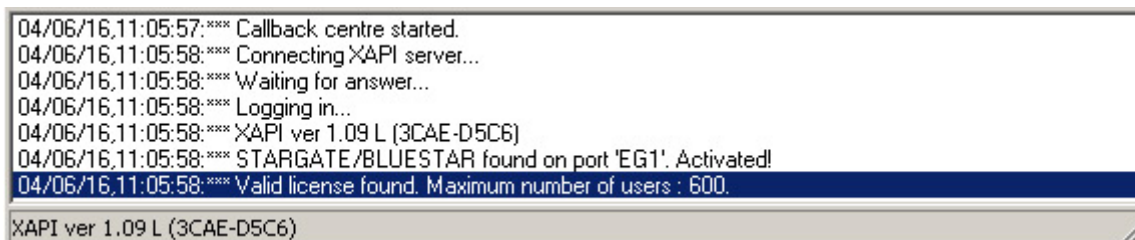

8.3. Configuration of Voice Callback Center software

8.3.1. How to add new user

In the Voice Callback center you can add as many users as the XAPI license enables. For each user you have to set CLIP (identification of user phone) and name of this user. You have to set also for each user amount of credit (tariff) for each group (destination). Automatic restoring of credit may be activated/deactivated in the settings section. In case that you are adding a lot of new users ,you can use tariff templates, which may be assigned to a new user. This templates are defined in section “Tariffs Templates”.

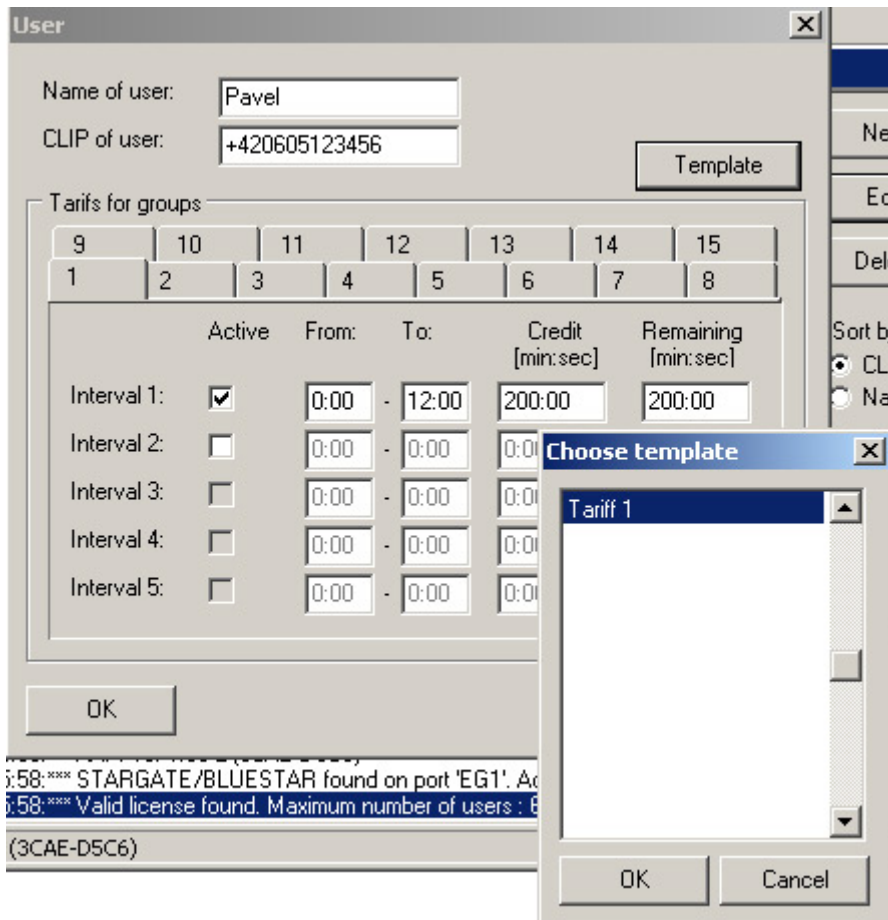

As you can see an example in the picture, user Tom has a phone number +420605215677 and credit rights for destination Group 1 only from midnight to noon. Credit for a month is 200 minutes. The user was created using template “Tariff 1”.

8.3.2. Tariffs templates

In this section you can prepare Customized tariffs. These templates you can use for quicker adding of new users.

8.3.3. Groups

Tables of prefixes. Each Group contains real destinations prefixes of calls (number which the customer dials by DTMF). Each user can use only defined Group (destination prefixes). The calls to PRI ISDN interface, which have prefixes restricted by user settings or which are not defined in these tables will be rejected !

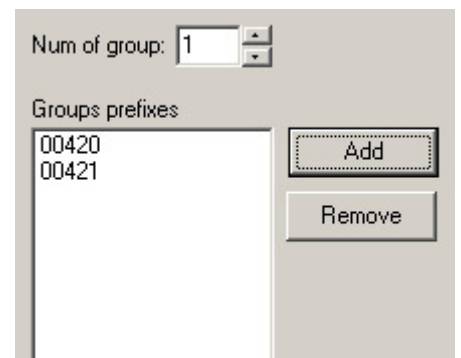

8.3.4. Prefixes to GSM

Currently not used, please do not change this table

8.3.5. Prefixes to ISDN

Currently not used, please do not change this table

8.3.6. Setting

Before you start to use Voice callback software you have to set parameter X10 in your PRI ISDN gateway by the following way :

- open the management software (e.g. PRIGW program)
- establish connection with the gateway (over serial interface or TCP/IP)
- in menu Gateway control open " Terminal "
- write a command **AT%X10=60** and press enter

If you sent the right command, the gateway responses OK.

Please before using of Voice Callback Center, check at 2N web pages (www.2n.cz/export) the latest version of XAPI server and Voice Callback Center software.

If you have a technical question, please contact 2N's technical support team at techsupport@2n.cz

9. StarGate / BlueStar / BlueTower Program User Manual

Configuration for StarGate , BlueStar and BlueTower gateways is same. Configuration program automatically detect type of system. In this section of manual is used abbreviation "PRIGW program".

9.1. Program Installation

PRIGW includes an installation CD with the configuration program installation. After the CD is inserted in your PC CD-ROM, the web browser will start. In section PRI gateway you find installation file of configuration tool. Wait until the installation is completed.

**) The program can be run under the MS Windows 98/ME/2000/XP OS only.*

9.2. Program Running

When the installation is complete, run the program by clicking on the "PRIGW program" in your PC menu, clicking on the icon on your desktop, or running the "**PRIGW program.exe**" file, which you can find on the appropriate location installed by you using any file explorer, commander or browser.

Having run the program, you can use:

- the main menu
- the button bar menu (included in the main menu too)
- the card (folder) menu

the Topics with configuration items

the Alphabetical Glossary with configuration items arranged in the alphabetic order

- a window for configuration item editing



9.3. Connection with PRIGW

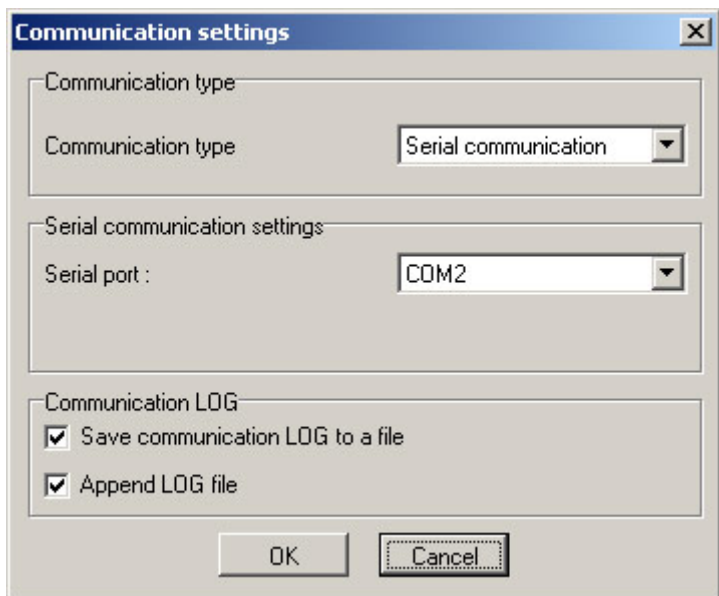

When the program is running, communication with the gateway has to be established for settings. This is done by selecting the "Setting > Communication" menu items. The basic setting is shown in the figure. For more details see section 9.5.

The "Gateway > Connect gateway" menu or the "Connect gateway" icon on the button bar can be used for gateway connection and gateway-PC communication establishing.

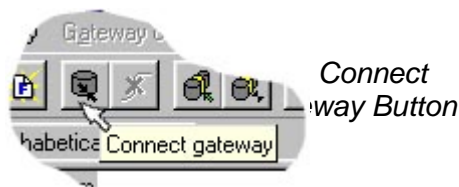

Select the "Modem" function only for remote gateway supervision using a connected modem. You can use a standard RS232* interface or Ethernet 10baseT (Telnet) connection the gateway.

*The PRIGW port transmission rate is **ALWAYS 57.600bps**.

Note: If you have more gateways than one, then follow the gateway communication instructions included in section 9.4.2.

9.4. Main Menu and Button Bar

The following menus are available here:

- File** - for physical work with the configuration file
(for saving, loading see 6.4.1)
- Gateway** – for physical gateway operations (one or more gateways)
(for connection, disconnection, etc. see 9.4.2)
- Gateway control** – gateway operation commands
(for diagnostics, reset, DISA, etc. see 9.4.3)
- Setting** – communication and language selections
- Help** – work with help.

9.4.1. File Menu

Using this menu, you can work with the **config.cfg** gateway configuration file or default configuration file, i.e. load, save, ... Contains an item for program end too.

- **Load** – loads the last-saved configuration file from the PRIGW program directory. Or requires loading of default settings upon first run.
- **Save** – saves the current settings into the file, the PRIGW program directory (or into a folder defined in the List of gateways – refer to 9.4.2).
- **Load from** – loads a file from a folder selected by you.
- **Save as** – saves a file into a folder selected by you.
- **Default settings** – loads the preset default configuration.
- **Program end** – terminates the program.

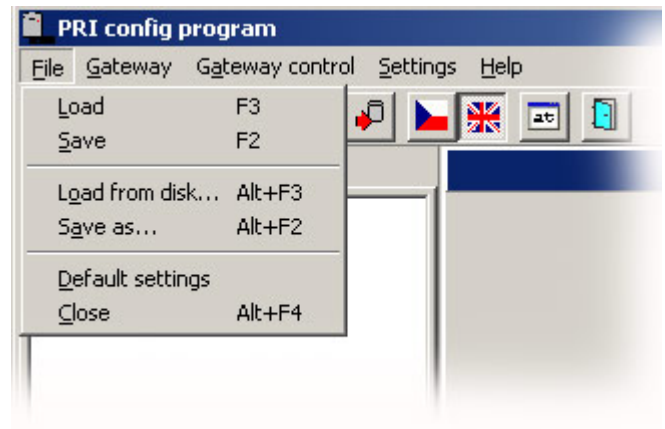

9.4.2. Gateway Menu

Used for connecting / disconnecting the gateway. You can select a gateway from the List of gateways if you use remote control.

- **Connect gateway** – connects the PRIGW with your PC and establishes mutual communication via an RS232 serial interface or using the Telnet protocol.
Note: The gateway must be connected and the "Setting > Communication" items have to be selected properly.
- **Disconnect gateway** – disconnects the gateway and discontinues its communication with your PC.



If you communicate with more gateways than one, you are advised to have each configuration file in a different directory to avoid unintentional rewriting of the configuration file by another gateway configuration. To do this, use the following menu:

Multi-gateway menu:

- **Select gateway from list** – select a gateway (directory with the configuration file) to be connected to the PC.
- **Connect gateway from list** – get connected to the selected gateway.
- **List of gateways** – edit the list of gateways including directories.

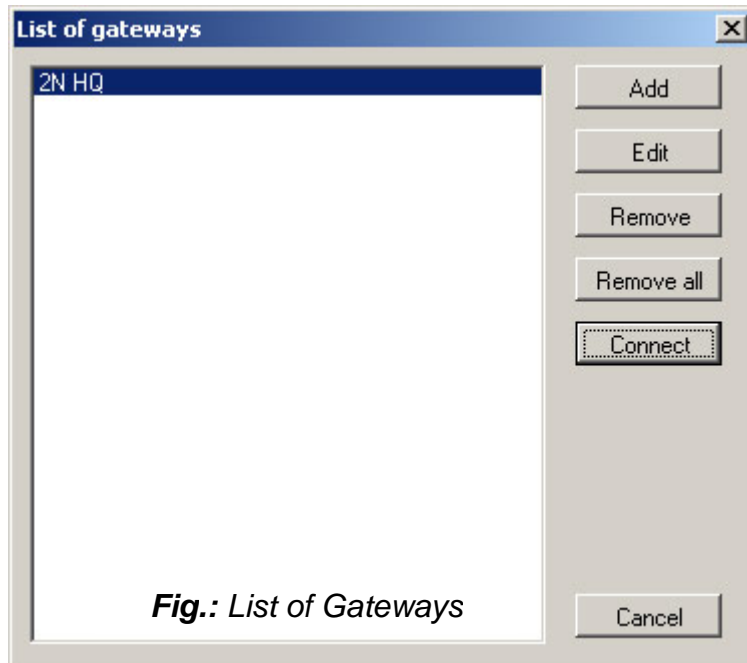

Fig.: List of Gateways

9.4.3. Gateway Control Menu

Contains commands for the PRIGW (available only if the PRIGW is connected).

- **Diagnostics** – information on boards (GSM modules and PRI board), contains 9 cards whose numbers correspond to those of PRIGW positions (00=PRI board).

PRI board – contains information on statuses of PRI ISDN layers and occupation of B-channels.

- Board status
- Layer status (both PRI interfaces)
- Mode of PRI interface (e.g. NT/M)
- Status of voice B-channels (both PRI interfaces)

The screenshot shows a 'Diagnostics' window with a tabbed interface. The 'PRI' tab is selected, showing details for PRI 1 and PRI 2. Each interface section includes layer status, mode, and a table of B-channel statuses.

Board status:
Board type: **PRI131** Status: **OK**

Detailed description:
Layer 1: **ACTIVE** Layer 2: **OKEST** Layer 3: **NULL**
PRI 1 (in mode): **NT/M**
Status of B-channels:

01-10	NULL	NULL	NULL	NULL	NULL	NULL	NULL	NULL	NULL	NULL
11-20	NULL	NULL	NULL	NULL	NULL	NULL	NULL	NULL	NULL	NULL
21-30	NULL	NULL	NULL	NULL	NULL	NULL	NULL	NULL	NULL	NULL

Layer 1: **DEACT Layer 2: **NOTEI** Layer 3: **NULL****
PRI 2 (in mode): **TE/S**
Status of B channels:

01-10	NULL	NULL	NULL	NULL	NULL	NULL	NULL	NULL	NULL	NULL
11-20	NULL	NULL	NULL	NULL	NULL	NULL	NULL	NULL	NULL	NULL
21-30	NULL	NULL	NULL	NULL	NULL	NULL	NULL	NULL	NULL	NULL

GSM board – includes information on statuses and types of GSM modules on the GSM board.

- **Board type** – type of GSM board
- **Layer 2,3** – status of the module communication layers.
- **GSM network** – name of the network the module is currently logged in.
- **Network ID** – ID number of the network (MCC+MNC) the module is currently logged in.
- **GSM cell** – identification number of the GSM cell the module is currently logged into. .

Description of displayed numbers:

NETCELL: A,BBB,CCC,DDDDD

A = status :

0 - not registered

1 - registered to home network

2 - not registered, but ME is searching for a new operator

3 - registration denied

4 - unknown

5 - registered to roaming network

BBB = first byte of LAC (location area code) in dec format

CCC = second byte of LAC in dec format

DDDDD = cell ID

- **GSM group** – number of actual GSM group.
- **Active SIM** – Number of active SIM card on this GSM module.
- **Module ID** - International identification number of the GSM module (IMEI).
- **Rev ID** – GSM module firmware revision number.
- **SIM Number** – SIM card serial number.
- **ID SIM card**– International identification number (IMSI) or SIM serial number (SCID) of SIM card.
- **Signal intensity** – the current signal level in the network the module is logged in (minimum value = -113 db – the module is logged out).
- **Sleep** button – used for conversion of selected desk into sleep mode
- **Block** button – block of selected GSM module (unavailable for outgoing and incoming calls).
- **Down** button – used for block the module after end of proceeding call
- **Reset** button – hardware reset of board, or GSM module

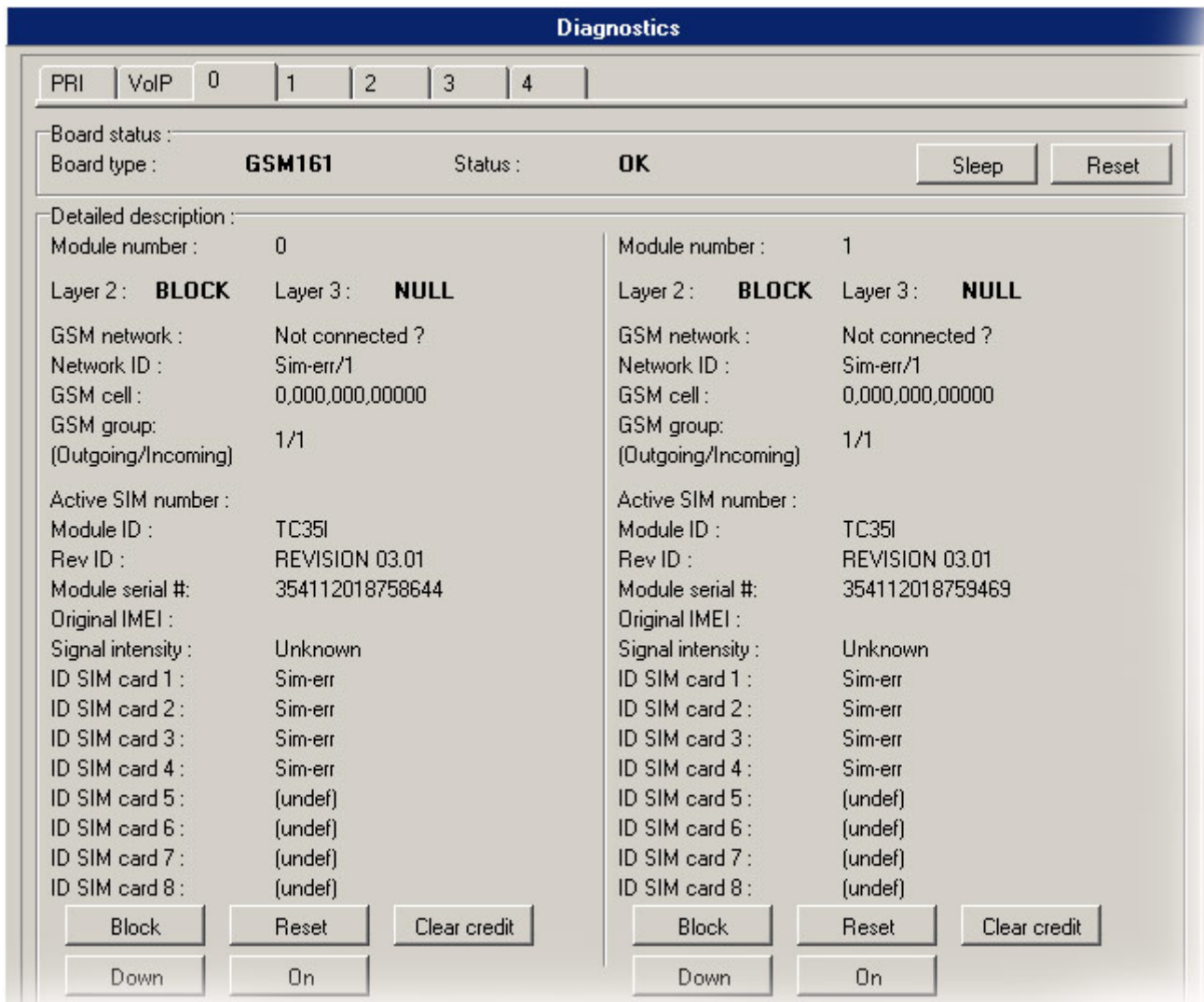

Every card features the “Sleep” (transition into the sleep mode – the boards does not receive any new calls or SMS and completes correctly the current calls or SMS) and „Reset“ (board reset) buttons.

If a board is not inserted in the PRIGW , this position (number) shows the „none“ board status.

- **Info on actual calls** – Information on currently made calls. This information can be arranged according to the GSM module, by B-channel. Or you can show only calls PRI1<>PRI2 or unsorted all calls.

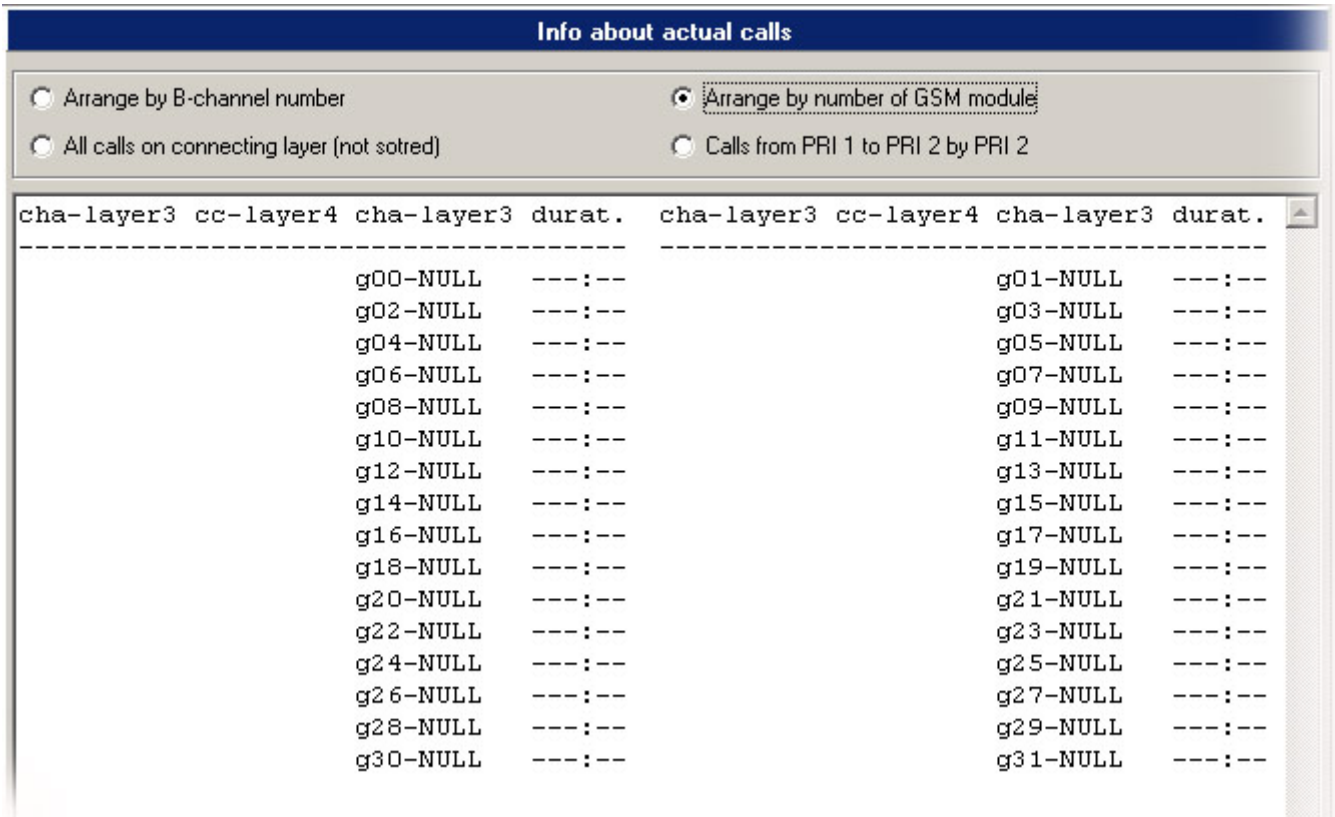

- **Connection status** – status of all possible remote/local PRIGW control ports.
- **Buffer status** – current buffer status (CDR). The maximum capacity is 511 calls.
- **Tracing** – item for storing traces from ISDN/IP layers.

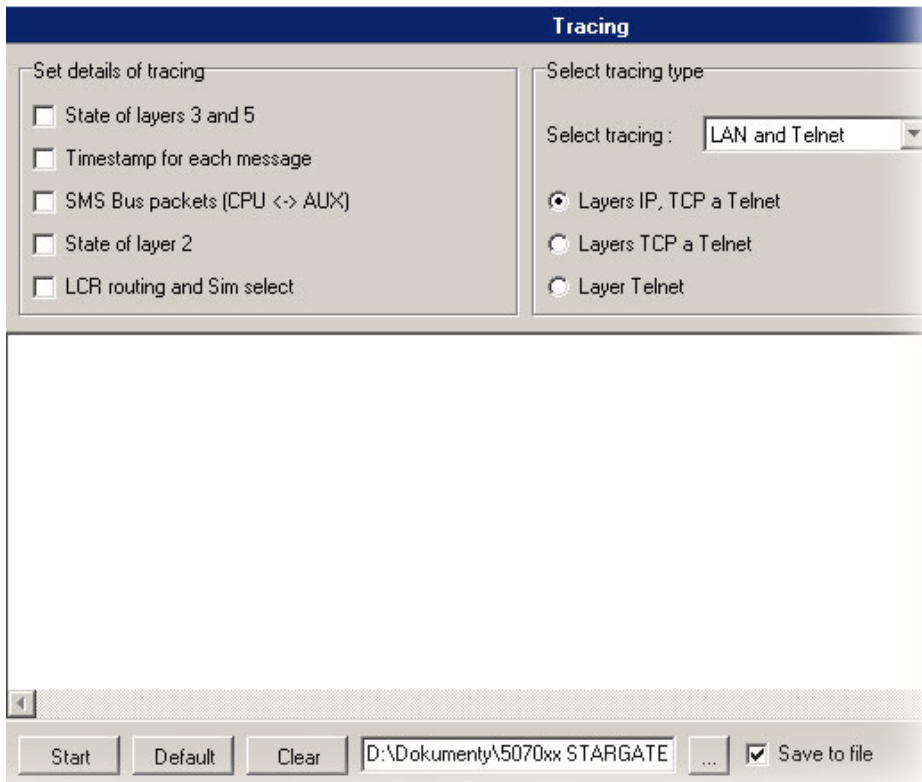

- **GSM Monitor info** – With using this feature you can download information GSM cell where is GSM module connected.

Description of response parameters from TC35i module:

Chann	ARFCN (Absolute Frequency Channel Number) of the BCCH(THC) carrier. If chann is h BTS supports hopping during a connection
Rs	RSSI (Received signal strength) of the BCCH carrier from 0 to 63. The indicated value is composed of the measured value in dBm plus an offset. This is in accordance with a formula specified in 3GPP TS05.08
dBm	Receiving level of the BCCH carrier in dBm
PLMN	PLMN ID code
LAC	Location area code (HEX)
Cell	Cell ID code (HEX)
NCC	PLMN color mode
BCC	Base station color mode
PWR	Maximal power level used on RACH channel in dBm or current power level
RXLv	Minimal receiving level (in dBm) to allow registration
C1	Coeficient for base station selection
TS	Timeslot number
timAdv	Timing advance in bits
Q	Receiving quality (0-7)
Chmod	Channel mode (S_HR: Half rate, S_FR: full rate, S_EFR: Enhanced full rate)

- **Export statistics** – used for storing and clearing of statistic data from the PRIGW connected. For a detailed description of statistic data refer on page 97.
- **Data into gateway** – sends and saves the configuration file into the gateway, the program then resets the gateway – for internal configuration updating – and saves the config.cfg file into the PRIGW program folder (or a folder pre-defined by you if you use the "Multi-gateway menu" options).
- **Reset** – resets the gateway and initializes all PRIGW boards (the gateway communication is not discontinued but all current calls and SMS to be sent are terminated!).
- **Factory reset** – resets the gateway, selecting the factory settings for the PRIGW . The gateway communication is not discontinued upon this command.
- **Firmware / Licence** – uploads the firmware into the gateway.

FIRMWARE uploading procedure:

- Prepare the firmware-containing file into a folder selected by you (**Pxxxx-V-xx.xx.xx.hex**).
- Select "Upload firmware" and open this file.
- The program now automatically uploads your new firmware – the gateway is reset during this procedure (thus discontinues all current calls and SMS). Do not interrupt the program during this procedure to avoid errors in firmware uploading – otherwise the gateway might stop working!

If the procedure of uploading firmware was terminated, please reset the gateway and re-load the PRIGW program and try to upload firmware again.

CAUTION!: Be sure to use original and undamaged firmware files for the firmware upload to avoid gateway function problems! For the latest firmware version see our websites (www.2n.cz).

- **Time and date** – sets time and date in the gateway.
- **Change username and password** – sets username and password for access to PRIGW via TELNET.
- **Set keylock** – input for licence key (see 7.1 page 30)
- **Download trace** – saves the gateway operation and error records on the disk.
- **Save call data** – saves records on calls on the disk (the records will remain in the PRIGW),
- **Save call data and delete** – saves records on calls on the disk and clears the call memory.
- **Voice message** – Used for loading / clearing of following messages:
 - Incoming DISA DTMF message (from GSM networks)
 - Connection message for 1st, 2nd, 3rd and 4th outgoing GSM groups
 - Voice message to PRI2 interface when PRI1 interface is disconnected.

You can upload DISA message by using file* which you prepare in your PC.

Maximum lengths of voice messages is following:

- DISA message = 64 seconds
- Connection messages = 8 seconds for each.
- PRI2 voice message = 16 seconds.

This sequence need temporary jumper reconfiguration of AUX board. In case that you want to make upload or download disa voice message by this way, please set jumpers on AUX board to right position (see on page 16 section 3.2.3) and also connect your PC via serial cable directly to COM2 on PRIGW gateway.

*parameters of voice file : codec ISDN aLAW, 8kHz, mono.

- **Test calls** – the gateway support test calls (for check voice quality or for check right configuration).

Test calls can be outgoing to GSM or ISDN interface with using AUX analogue interface (connected analogue interface), or incoming (incoming call from ISDN or GSM interface will be connected directly to AUX interface), or with using two GSM modules for make test GSM to GSM.

In case of proceeding call the gateway atomically generates trace, which you can save for possible check in case of problems.

Test calls

Test call from AUX test interface :

- Rotating B-channels
- Via B-channel number
- Via GSM module number
- Connect 2 GSM modules

Called number :

2nd called number :

Limit : (0=off)

To GSM (according to called prefix)

Connect following incoming call

- First incoming call from ISDN
- Incoming call from B-channel number
- From gsm module number
- First incoming call from GSM

Save to file

9.5. Setting Menu

Contains the communication and program language menus.

Communication

- **Direct to COM port** – Program communication through serial interface RS232
- **Modem** – Communication through connected modem.
- **ISDN modem** – Communication through ISDN modem and PRI card on PRI gateway
- **TCP/IP** – Communication through TELNET protocol through Ethernet.
- **Transmission rate** – the recommended and default value is 57.600bps.

9.5.1. Help Menu

Contains a help to the PRIGW program, instructions for use of the help and details on the program version.

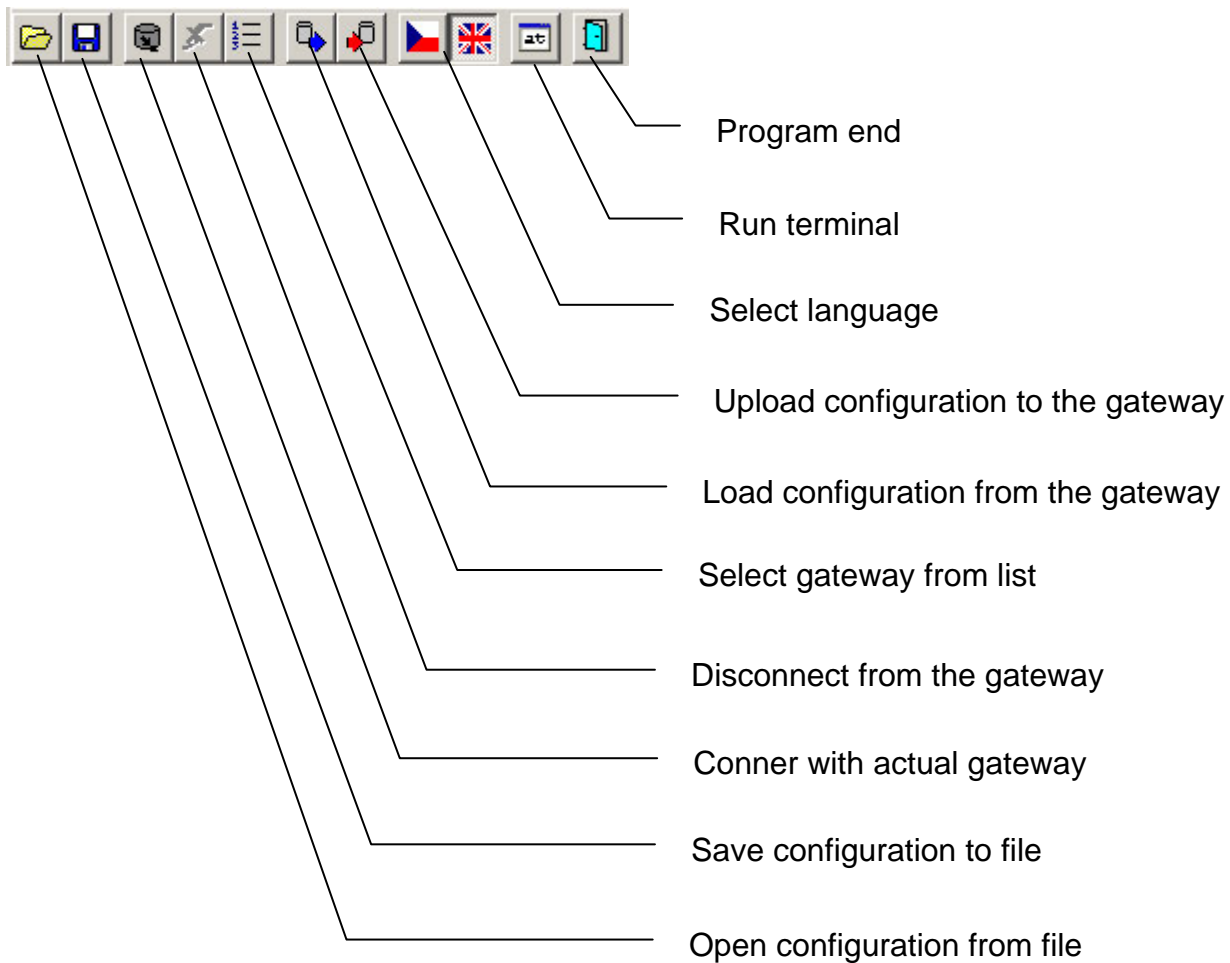

9.5.2. Button Bar



9.6. Configuration sections

There are two types of configurations parameters in the gateways:

- Online configuration parameters: In this section you find parameters which you can change only when a PRI gateway is connected (e.g. setting time and date). Possibility to change parameters you can check by color of icon:

-  Date/time = gateway is disconnected, there is no possibility to change online parameters
-  Date/time = gateway is connected, you can change values of online parameters.

Online section also contains all diagnostics tools.

- Offline configuration parameters: The others parameters which you can set offline (can be saved to cfg file).
- Reset commands : Section for make reboot of connected gateway, or reboot with load factory default configuration.

9.7. Configuration

As already mentioned, the program includes the "Topics" and "Alphabetical glossary" folder menus. These menus contain identical items (as shown in the figures below) and it depends on the user which menu he or she chooses for easy orientation. You can set ISDN GSM gateway parameters in these menus.

9.7.1. Topics and Alphabetical Glossary

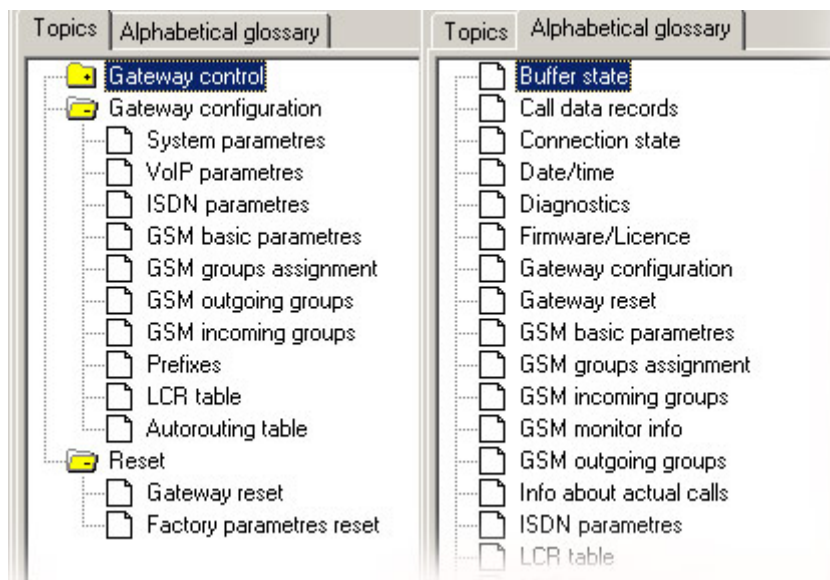
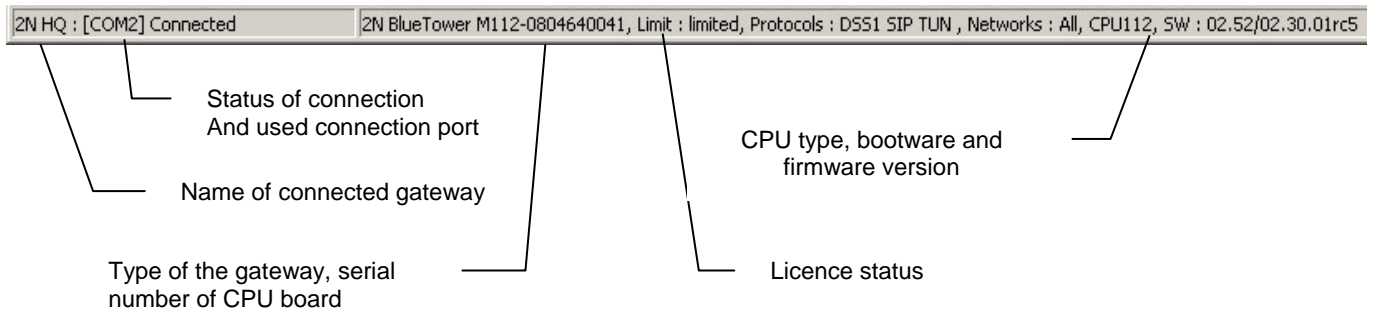

Fig.: Topics

Fig.: Alphabetical Glossary

9.7.2. Status line

In status line of configuration you can find basic information about connected gateway:



9.7.3. Offline configuration

All configuration sections contains following buttons:

- **Save to gate** : Upload all parameters of the section to the gateway
- **Load from gate** : Download all parameters of the section from the gateway
- **Default** : Load default values for this section
- **Save to file**: Save all parameters of the section to selected configuration file

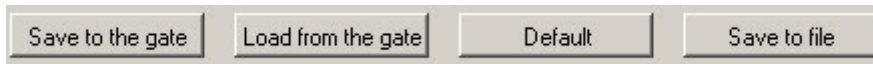

9.7.3.1 System parameters

The screenshot shows a configuration window titled "System parametres". It is divided into several sections. On the left, under "IP settings", there are input fields for IP address, Subnet mask, IP router, and Init sequence for modem. Below these are a dropdown for "Saving call data (CDR)" set to "Successful outgoing", a "Gate ID" dropdown set to "0", a "General selection of SIM" dropdown set to "According to gsm grc", and two "Number for remote control" fields (PRI 1 and PRI 2). At the bottom left, there is a "Gateway will be configured as (will use protocol)" dropdown set to "ISDN-DSS1". On the right, under "Automatic log-out of GSM module", there is a checked "Enable automatic log-out" checkbox and three dropdowns for "Log-out hour" (0), "Log-in hour" (1), and "Min. logged-in modules" (10). Below this is a section for "Automatically move to summer/winter time" with an unchecked checkbox and two date fields. At the bottom right, there is a "PIN" field set to "1234", an unchecked "Enable upgrading FW through Ethernet" checkbox, and a "Port" dropdown set to "0".

This window allows you to set the basic parameters of your PRIGW .

- **IP address** : IP address of the PRIGW's CPU card Ethernet port
- **Subnet mask** : IP mask of IP address
- **IP router** : IP address of network gateway of your Ethernet network
- **Init sequence for modem** : an AT command sent by the PRIGW via COM2 when it detects a connected modem.
- **Saving call data (CDR)** : Type of CDR which gateway will save.
 - **No calls** – the gateway does not record any call information.
 - **Successful outgoing** – gateway records information of all successfully connected outgoing calls
 - **Successful outgoing+incoming** – gateway records information of all successfully connected outgoing+incoming calls.
 - **All outgoing** – the gateway records information on all outgoing calls.
 - **All outgoing+incoming** – the gateway records information on all outgoing and incoming calls.
- **PIN** : the PIN code that the gateway tries to enter if a SIM card with active PIN is inserted (this item has no meaning if a SIM card without active PIN is used).
- **Gate ID** : the number which will be added to call data records line. With this number you can more easy detect on which PRIGW were CDR generated (in case that you collecting CDR from more than one PRIGW gateways)
- **General selection of SIM cards** : selection of SIM card after start/restart of PRIGW
 - **According to GSM groups** –SIM card will be selected by GSM group settings.
 - **SIM cards in slot X** – after start/restart will be chosen SIM card in holder X (In case that setting in GSM group is different, SIM will be automatically switched according to GSM group settings)

- **Number for remote control:** number for remote control via DATA B-channel (this feature is optional)
- **Automatic log-out of GSM modules :** This function is used for automatic log out of modules in selected time. If logged in modules are occupied by a call, the logged out modules log again in to the net automatically. If the traffic decreases, the modules log out again from the network at random intervals
 - **Enable automatic logout** – Permission / prohibition of this function.
 - **Logout Hour** –The time when modules start to log out randomly from the GSM network
 - **Login Hour** – The time when the modules start to log in again to the GSM network
 - **Min. logged-in modules** – The minimal number of GSM modules that remain logged in.
- **Automatically move to summer/winter time** – for automatic switch summer/winter time
- **Gateway will be configured as** – By this parameter you can set which protocol will be activated in the gateway. ISDN-DSS1 must be activated in case that in the gateway is PRI ISDN board. VoIP-SIP is for gateway with VoIP board.

9.7.3.2 ISDN parameters

PRI ISDN connection settings.

The screenshot shows a configuration window titled "ISDN parametres". It is divided into several sections:

- ISDN**:
 - PRI 1**:
 - ISDN PRI port type: NT
 - Synchronization: Master
 - Channel number select: Upwards
 - Preferred channel: 0 (0 = no preferred)
 - PRI 2**:
 - ISDN PRI port type: ZE
 - Synchronization: Slave
 - Channel number select: Upwards
 - Preferred channel: 0 (0 = no preferred)
- TEI address**: 0
- Assignment of GSM-channel**: Cyclical
- CRC**: CRC (Valid for both PRI ports if they are presented)
- Progress elements numbers**:
 - Message SETUP_ACKNOWLEDGE: 8 (0 = off)
 - Message SETUP_PROGRESS: 0 (0 = off)
 - Message SETUP_PROCEEDING: 8 (0 = off)
 - Message SETUP_ALERTING: 8 (0 = off)
- Error GSM causes**:
 - Lack of digits in OVERLAP mode: 102
 - Cause transfer: (empty field)

ISDN

- **ISDN PRI 1 port type** - defines the type of the PRI 1 ISDN port on the PRIGW PRI ISDN board. ISDN PRI is a point-to-point connection. The gateway must have an opposite port type than the device it is connected to*.

[PRI 1 port is always set as internal – there is activated LCR function, PRI 2 port is always set as external – all calls from PRI 2 port will be rerouted to PRI 1 port. PRI 2 port has ALWAYS opposite mode than PRI 1 port !!](#)

- **Synchronization** – selects the device to transmit the synchronization clock.

- **Master** – the gateway sends the synchronization clock, the connected device must be set to receive the synchronization clock.
- **Slave** – the gateway receives the synchronization clock from the connected device.

- **TEI management** – gateway identification address (0 by default, 62 max.)

- **Channel number select** – defines way of occupation of B-channels on PRI interface

- Upward > gateway will occupy channels from channel 1 to 32
- Downward > gateway will occupy channels from channel 32 to 1

- Preferred channel > number of first channel which the gateway will try to occupy.

- **Progress elements numbers** – defines which type of element progress will gateway send in messages SETUP_ACK, PROGRESS, CALL_PROCEEDING, ALERTING. The number depends on PBX/ROUTER which you have connected. You have to set right number according your PBX. In case that you use wrong number or set sending of the element, it can cause problems on PRI ISDN trunk (no connected calls, no opened B-channel...)

Dec	Meaning
1	Call is not end-to-end ISDN or may be in-band information
2	Destination call address is non-ISDN
3	Origination call address is non-ISDN
4	Call has returned to the ISDN
8	Inband treatment has been applied
10	Delay in response at the call interface

- **TEI management** – gateway identification address (0 by default, 62 max.)

- **CRC** – Parameter for Activating/deactivating receiving CRC on Layer 1 on PRI ISDN interface. (In both modes the PRIGW sending CRC).

- **Assignment of B-channels** – defines how the gateway shall route outgoing calls to the GSM network.

- **Cyclical** – the gateway routes outgoing calls according to pre-defined groups (prefixes). The GSM modules are assigned to the groups automatically according to the GSM provider (GSM network number). If more GSM modules (SIM cards) are assigned to a group for outgoing calls, these GSM modules are occupied gradually in a rotating way (1. > 2. > 3. > 4. > 1. > 2. ...)
- **Locked** – the gateway does not provide intelligent outgoing call routing. Calls on the x-th B-channel are made via the x-th GSM module. However, it is necessary to define and select so many GSM groups as there are SIM card types in the gateway.
- **According to credit** – the gateway routes calls as in the rotating mode but selects the GSM modules according to the lowest number of called minutes instead of cyclically.

Caution! Be sure to select the GSM groups according to available providers while selecting the Assignment of B-channels=locked!

**) If you do not have the appropriate crosses/non-crossed interconnection cable (depending on the configuration of the equipment connected to the PRIGW), you can re-set the gateway PRI board jumpers to achieve functional connection.*

- **Error ISDN causes** – Definition of causes sent to PRI ISDN (in the Release Complete) whenever an incoming call from PRI ISDN is rejected.

- Few digits on OVERLAP dial mode – Rejection of an incoming call that does not meet the required number length (default cause: 102-Timeout).

- Disallowed dial number prefix – Rejection of an incoming call whose prefix does not match any of the prefixes defined for GSM groups (default cause: 21-Reject)

- Selected module/GSM group are not ready – Rejection of an incoming call because no free module has been found in the particular GSM group (the assigned GSM module is not available for the „Locked Channels“ mode) and no other preferred GSM groups have been selected (default cause: 41-Tempfail).

- Selected module/GSM groups are not ready – Rejection of an incoming call because no free module has been found in the defined GSM group + preferred groups have been selected for overflow but no free outgoing GSM module has been found here (default cause: 42-Swcongest).

- **Cause transfer** – List of numbers of releases causes which the PRIGW receive from GSM networks and which have to be translated to different causes to ISDN PRI interface.
- **Allow delete of statistics on PRI every month** - Allow/Restrict automatic reset of PRI statistic every x. day in month.

- **Digits count in SETUP** – Sets how many digits will be send in SETUP message (in case of outgoing call), the others digits will be send in OVERLAP mode.

Example: called party number : 6012345678 , digits count in SETUP = 7

Outgoing signalization messages:

SETUP (contains 6012345)

INFO (6)

INFO (7)

INFO (8)

- **Dial tone to NT interface on empty SETUP** – With activated this feature, the gateway will send dial tone in case that receive SETUP message without called party number
- **Ring tone** – Select type of ring tone in case that there is no open B-channel to GSM/3G network.
- **Numbering plan settings** – Parameters for set correct numbering plan pro Called and Calling party number (default is 0 = unknown)
- **Hungarian tone after 2 digits** – special feature for Hungary, gateway will send specifics dial tone after it receive tow digits.
- **Generate disconnect tone to PRI (s)** – In case of reject a call, gateway will generate busy tone for defined time, then call will be correctly terminated.

9.7.3.3 VoIP parameters

Setting of VoIP – SIP interface

Date of deleting statistics – a day in a month on which all statistical data on the VoIP interface are deleted automatically.

SIP registration – set the parameters of PRIGW registration at the SIP Proxy;

Registration expires – the timeout after which the PRIGW registration data get expired at the SIP Proxy.

Reattempt registration – the timeout after which the request is resent.

Username and password – SIP Proxy registration data.

SIP protocol setting – used for setting SIP report sending during establishing connection.

IP addresses – used for setting IP addresses of interworking network devices and default port numbers through which PRIGW will communicate with them.

SIP Proxy (GSM->IP) – the IP address of the SIP Proxy to which VoiceBlue Lite turns in the case of an incoming GSM call.

SIP Proxy (IP->GSM) – the IP address of the SIP Proxy from which VoiceBlue Lite awaits outgoing GSM call requests.

SIP registrar – the IP address of the SIP registration server.

NAT firewall – the NAT firewall IP address.

VoIP card / MGCP gateway: IP address of VoIP card of the gateway

STUN server – IP address of the STUN server (Simple Traversal of UDP through NAT's (Network Address Translation)), which is used for

obtaining of public IP address presented to Internet. It is useful to fill in this field in case the PRIGW is present in a private network behind the firewall or NAT. Default port for sending of requests on STUN is 3478. Next STUN server request [s] – for setup of time period between two requests for public IP address information. This request will gateways makes each start/restart of system.

Codec priority: The sequence of offered VoIP codec in case of new VoIP call.

9.7.4. GSM

9.7.4.1 Basic settings

Settings of basic parameters of GSM.

- **Number of digits dialed from ISDN** – sets outgoing ISDN dialings into GSM networks.
 - **Maximum** – the maximum number of digits to be dialed into a GSM network. Any dialing longer than or equal to this parameter is dialed automatically (without waiting time).
 - **Minimum** – the minimum number of digits to be dialed into the GSM network.
 - **Waiting for next digit** – time (in seconds) for the PRIGW to wait for the next dialed digit. After this timeout, the number is dialed automatically into the GSM network.
- **Voice parameters of GSM/3G modules** – sets parameters of GSM modules.
 - **Receive/Transmit level** – selects the receive/transmit volume. Caution! We recommend you to keep the default value to avoid negative effects upon other transmission parameters, such as echo. Do not change these settings unless absolutely necessary.
- **Call delay** - the minimum timeout between the end of a call and the beginning of another outgoing call for one GSM module (Incoming and outgoing calls are not rejected during this timeout). The optimum time is 2 seconds. Unless absolutely necessary, do not change the default value to avoid system instability.
- **DTMF number** – sensitivity of DTMF receiver from GSM network. Parameter “delay” means 10*milliseconds which is added to default value 20ms. The total time is

minimal delay between two DTMF chars. Example: DTMF number=30
delay=30*10+20=320

- **SIM card number** – with this parameter you can choice which type of serial number of SIM card will the gateway read.
 - **IMSI – International Mobile Subscriber Identity**
 - **SCID – SIM Card Identification number** (supports only Siemens GSM modules)
- **Text for SMS at no answer** – parameter for text which will be send to called party in case that this feature is activated (see GSM outgoing group settings). If you will add to the text string %N, this string will be replaced in SMS by Calling party number.
- **Settings for 3G Motorola phones** – specifics dialing parameters for 3G Motorola mobile terminals.
- **Disable CLIP from GSM to ISDN** – by using this parameter you will disable transfer incoming identification of calling party from GSM/3G networks.
- **Generate busy tone to GSM (s)** – In case of rejected incoming call the gateway will generate busy tone during defined time, then it makes disconnect of the call.
- **Received SMS save to** – With this parameter you can select memory where will be SMS stored (GSM module or SIM card)
- **Use networks (only 3G modules)** – Type of wireless network which you have to use (GSM, 3G or both types)
- **Searching priority** – Priority for connect to specifics type of wireless network.

9.7.4.2 Assignment to GSM groups

Table of assignment GSM modules to Outgoing (PRI>GSM) and to Incoming (GSM>PRI) GSM groups. (0. and 1. GSM module is in first GSM board position – on left side next to PRI board). Number of GSM modules corresponds with type of the gateway.



Module :	Outgoing :	Incoming :
0. module	1. Group	1. Group
1. module	1. Group	1. Group
2. module	1. Group	1. Group
3. module	1. Group	1. Group
4. module	1. Group	1. Group
5. module	1. Group	1. Group
6. module	1. Group	1. Group
7. module	1. Group	1. Group

9.7.4.3 GSM Outgoing Groups

Settings of GSM outgoing groups (and SIM cards*). In this section you can set all rules for each SIM card in system for outgoing call from ISDN PRI to GSM networks.

*placement of SIM holders on GSM boards you find in the section GSM board in this manual

Mode of switching SIM card – method, how SIM cards will be switched in selected GSM group.

- **SIMX** - active will be the SIM card in position X
- **OFF** – SIM cards in GSM group is switched-off.
- **By time** – SIM cards will be switched according to time and day (see below “Time of use SIM”)
- **Random** – SIM cards will be switched at random time (length of this time will be generated between two times in parameter “Interval of change SIM card” (see below)
- **By time and limit; then SIM 1** – SIM cards will be switched according to time and day and credit. In case that all SIM card have no credit (counters are empty), the SIM card in position one will be activated.

- **Random and limit ; then SIM 1** – SIM cards will be switched at random time and by credit. In case that all SIM card have no credit (counters are empty), the SIM card in position one will be activated

Last searched SIM – (SIM1 – SIM8) : After start the gateway is automatically checking all SIM position for SIM card. With this parameters you can limit holders which will be tested. SIM cards which were not tested have in diagnostic window status “(undef)”.

Disconnect call – Setting for forced disconnection of proceeding calls

- **SIM limit exceeded** – The call will be disconnected immediately when the SIM card's call limit is exceeded.

- **Switch to another SIM card** - The call will be disconnected immediately when the SIM card will be out of time of use.

Day of delete statistics in group - x. day in month when the statistics of the GSM group will be deleted.

No ALERTING before CONNECT – by activation this parameter you remove ALERTING message from messages sequence of building outgoing calls to GSM.

Delay for send CONNECT (s) – Delay for send ISDN message CONNECT to ISDN PRI interface (in case that PRIGW is building call from ISDN to GSM).

Timeout for send ALERTING(s) – Timeout for send the ISDN message ALERTING to ISDN PRI interface (in case that PRIGW is building call from ISDN to GSM). 0= switched off

Timeout for SMS at no answer (sec) – Minimum length of ringing outgoing call. In case that this time will be longer that this parameter and call will be not connected, gateway will send to called party number SMS message with defined text. For right function of this feature you have to have called party number in defined format – national or international where is “00: instead of “+”.

SIM settings – By this parameter you can change assignment of times from parameters “Time of use”

- **SIM 5-8 is SIM4** - Time limitation of SIM cards 5-8 will be same as SIM cards in position 4.

- **SIM 5-8 is SIM1-4** – first time interval in bookmarks SIM1-SIM4 will be used for SIM cards in positions 1 – 4. Second interval (2nd interval) in these bookmarks will be used for SIM cards in position 5 -8.

Allow tone detector – Enables ring tone detectors on GSM boards.

‘Minute’ parameter – By this parameter you can change counting of outgoing calls.

- **Count of minutes** – Gateway will counter time of outgoing calls. You can set maximum of minutes by parameter Number of called minutes

- **Count of calls** – Gateway will counter number of outgoing calls. You can set maximum of outgoing call by parameter Number of called minutes.

Bookmarks SIM1- SIM4-8 – In these bookmarks is necessary right set-up parameters of each SIM card..

Roaming enabled for network – Whole or part (mask character is “x”) of international ID of GSM network (MCC+MNC) which is enabled for roaming. Please leave it free for cases that you don't want to enable roaming.

Example:

- <empty> ...roaming restricted
- 2300 ...roaming restricted (minimum is five digits)
- 23002 ...roaming enabled only to network code 23002
- 230Xx ...roaming enabled to network codes from 23000 to 23099
- xX001 ...roaming enabled with codes which has last three digits = 001
- xXXxX ...roaming enabled to ANY GSM/3G network code

CLIR – This parameter decides whether the gateway SIM card subscriber number shall be dialed into the GSM network or not. All PRIGW outgoing calls present the calling line numbers as inserted in the SIM card in the PRIGW. Technically, it is impossible to transfer number information from the ISDN into the GSM network (the opposite function is supported, i.e. all ISDN subscribers can see the GSM calling number). Hence, it is mostly purposeful to restrict the calling line identification (activate CLIR) to avoid problems with back calls to the gateway in the case of a missed GSM call, for example. Select this parameter for each GSM group separately.

- **Default** - settings according your GSM provider's network.
- **Enabled (CLIP-off)**** – The CLIR function is activated, no numbers are sent to the GSM network. **CAUTION!** Your GSM provider must support **and activate** this service! If not, the number will still be sent to the network and outgoing calls will be impossible with some providers.
- **Disabled (CLIP-on)** - the CLIR function is disabled, numbers are sent. Your GSM provider must support and activate this service! If not, the number will still be sent to the network and outgoing calls will be impossible with some providers.

**Some GSM network (SIM cards) not support activation CLIR via GM22 GSM modules, in status window you will see Network: clir-err.

Number of called minutes – Time call limit for one month for the SIM card.

Number of SMS messages – Number of SMS messages sent via the SIM card / one month.

Day of restore limits – Day, when counters “time call limit” and “SMS” will be reset to zero (1 to 31, 32 = limits will be restored every midnight).

First count – length of first count. After this timeout PRIGW uses parameter “next count” to calculate the length of the call. (1 to 250 seconds).

Next count – length of next counts (1 to 250 seconds) . **Next count** – length of next counts (1 to 250 seconds) .

Parameters First count and Next count are used for calculating of the real length of the call from the view of GSM operator.

Example 1: If your calls are charged second by second set both parameters to 1.

Example 2: If you are charged immediately after answering a call for the whole first minute and then second by second set first count to 60 and next count to 1.

Proper setting of these parameters helps you to keep real record of the minutes spent and charged for each SIM. These parameters are used for limit counters, statistics (not for the CDR).

Time of use SIM – Interval of using selected SIM card. Caution!: If parameter “Time of use will be overlapped by another SIM (in one GSM group) – in this case can come about unspecified switching of SIM cards – can be selected another SIM cards !

Unlock on weekends – Permission/prohibition of this group during weekends (Saturday, Sunday)

Interval of change SIM card – in this interval hours:minutes will be randomly switched SIM card. (SIM card will be switched after proceeding call hang-up).

9.7.4.4 GSM Incoming groups

Settings for incoming calls from GSM networks to PRI ISDN interface.

The screenshot shows the 'GSM incoming groups' configuration window. The 'Mode' is set to 'Reject incoming calls'. The 'List of called numbers' is currently empty. The 'Day of deleting stats' is set to 1. The 'Looping of voice mess' and 'Time to keep CLIP in table' are both set to 0. The 'Add record only for unconnected call' and 'Delete record for connected answer' checkboxes are unchecked.

Incoming calls to ISDN – setting of the method how PRIGW will process incoming calls from GSM network and route to PRI ISDN interface.

Mode – mode, how PRIGW is answering to incoming calls from GSM network.

- **Reject incoming calls** - by selecting this item you bar GSM incoming calls (the calling subscriber gets the busy tone*).
- **Ignore incoming calls** – by selecting this item you ignore GSM incoming calls (but -the calling subscriber gets the ringing tone).
- **Receive incoming calls + voice message** – incoming calls will be routed to ISDN interface according to following parameters.
- **Receive incoming calls + dialtone** – incoming calls will be routed to ISDN interface.
- **After ring callback / refuse** – activated callback (for CLIP with is saved in Autorouting/Callback table. The others calls will be rejected).
- **After ring callback / Ignore** - activated callback (for CLIP with is saved in Autorouting/Callback table. The others calls will be ignored).
- **Report to PC + voice message** – external callback (for callback centre) with saved voice message.
- **Report to PC + dial tone** - external callback (for callback centre) with dial tone.

Minimum digits in DTMF – Minimum of DTMF digits in DTMF dial-in

Maximum digits in DTMF – Maximum number of digits to be DTMF-dialed for incoming calls. After the last DTMF dialing, which is the maximum, an ISDN call is made automatically with the currently selected DISA (or DTMF prefix if necessary).

Timeout while inputting DTMF digits(s) – time (in seconds) for the PRIGW to wait for the first and next DTMF digit. After this timeout, either the DTMF number received so far is dialed into the ISDN or, if no DTMF digit is dialed, a number is dialed from the “List of dialed numbers”.

List of called numbers - list of numbers to dialed automatically gradually (in the case of unavailability or busy) if no DTMF dialing (DISA) is made.

Prefix before DISA preselection – prefix which the gateway add before dialed DTMF dial in. For example : received DTFM digits are 487 and this prefix is 6655. The gateway will send to PRI ISDN interface number 6655487.

CLIP - With this parameter you can change digit „+“ from CLIP by different digit(s). In case that you leave blank this parameter, the gateway will only remove „+“ from CLIP

Looping of DISA message – setting of automatic repeat of DISA voice message in case of incoming DTMF dial-in.

Time to keep CLIP in table – parameter for AutoCLIP routing. By this parameter you can set time how long will be saved information about outgoing call to GSM. 0= switch off AutoCLIP function.

Add record only for unconnected call – Gateway can save to AutoCLIP routing table only unconnected outgoing calls or also connected calls.

Delete record for connected answer – Gateway can delete record from AutoCLIP routing table immediately after connection of the answer call, or only after record expiration sets by parameter “Time to keep CLIP in table”.

Direct routing – With this group of parameters you can set direct incoming routing to different destination from each GSM/3G module

GSM/3G module no.	Called number to ISDN/VoIP	GSM/3G module no.	Called number to ISDN/VoIP
0 module :	<input type="text"/>	16 module :	<input type="text"/>
1 module :	<input type="text"/>	17 module :	<input type="text"/>
2 module :	<input type="text"/>	18 module :	<input type="text"/>

9.7.4.5 Prefixes

Tables of prefixes for GSM operators.

Table of replaced prefixes – table of prefix, that are to be replaced (in outgoing call from PRI ISDN to GSM) to another prefixes (e.g. +420 replaced by 0)*

*this change will be made before finding the right prefix in the table of prefixes!

Table of prefix – table of called prefixes from PRI ISDN. At filling-in this table you can set the length of called number. In case that this parameter you didn't fill-in, PRIGW uses parameter „Default number of digits“

Network number – ID number of GSM network for these prefixes – only for your info

Prefix change for call from PRI1 to PRI2 – table of prefix, that are replaced (in outgoing call from PRI 1 ISDN to PRI 2 ISDN) to another prefixes (e.g. +420 replaced by 0).

9.7.5. LCR table

LCR table			
Network	Using time	Groups	Limit
1/23003	0:00/24:00	123	0

Table of outgoing Least cost routing (LCR). Each outgoing call from PRI 1 interface will be routed to GSM according to this table. PRIGW at each call checks line to line and in case that called prefix is same as prefix in network list and actual time is time limitation limits, call will be routed via defined GSM group(s) or via PRI 2 interface.

Network list number – number of “Network list”

Time limitation – validity time of this line

Weekend – parameter determining if these line is valid on weekends and holidays.

Groups - Destination GSM group(s) for outgoing call to GSM (in case that first GSM group will be unavailable, call will be re-routed via next GSM group, or cancelled (without setup ACK))
Limit - Maximum length of call (in minutes). After this limit will be call disconnected. Maximum is 60 minutes. In case that you set limit=0 the length of call will be unlimited (limited by GSM network).

9.7.6. Autorouting / Callback table

Autorouting table			
GSM number (CLIP)	Dial	Limit	Autorouting type
+420261301500	123		Autodial

Table for Callback and Autorouting function.

Callback – In case that you activate in GSM incoming group callback, you can add authorized CLIP which can use callback function

Autorouting – You can add for each CLIP defined destination in PRI 1, these CLIPs will be automatically connected directly with defined number on PRI ISDN 1 trunk.

Limit – maximum length of call.

10. Accounter program

The program for remote automatic download cdr information from up to 8* PRIGW units via IP connection (TELNET).

**only accounter for Windows, for OS Linux is one script for one PRIGW unit.*

10.1. Accounter Program Installation

PRIGW includes an installation CD with the Accounter program installation. After the CD is inserted in your PC CD-ROM (or the diskette is inserted in your PC diskette drive), the installation will start. If you have not selected the automatic running of CD after insertion (or use diskettes), run the installation program to start the installation. Wait until the installation is completed.

**) The program can be run under the MS Windows 95 OSR2/98/ME/2000/XP OS only.*

****) For OS LINUX you can use 2N-accounter script*

10.2. Accounter Program Running

When the installation is complete, run the program by clicking on the "Accounter program" in your PC menu, clicking on the icon on your desktop, or running the "**Accounter.exe**" file, which you can find on the appropriate location installed by you using any file explorer, commander or browser.

If you want to use this function on OS Linux you have to use special script with these functions.

How to install Accounter script in OS LINUX:

- Unzip file: unzip Linux-accounter.tar.gz
- "Untar" file: tar xvf Linux-accounter.tar
- after it you will have directory: Linux-accounter
- Inside this directory, you run file "install" : (./install)
- Script for connect, download cdr and save it to file with format yyyy-mm-dd has name "2N-accounter". (run type command ./2Naccounter)
- File "run-2N-accounter" will configure Linux utility "cron" to every 20 min run script 2N-accounter. (to run type command ./setup-cron).(Setup will modify Linux CRON program)
- Please, before run file, you must configure IP address, username and password in script "accounter.pl"
- previous files and files with cdr info and log file you find in directory: /usr/bin/accounter
log file- accounter.log
cdr info file- yyyy-mm-dd

10.3. Description of Accounter program

Program is dedicated for automatic downloading and saving cdr info about calls made via PRIGW and their savings in the text files. The communication with PRIGW is established in chosen times moments via Ethernet with help of Telnet protocol (port 23) or via connected ISDN modem.

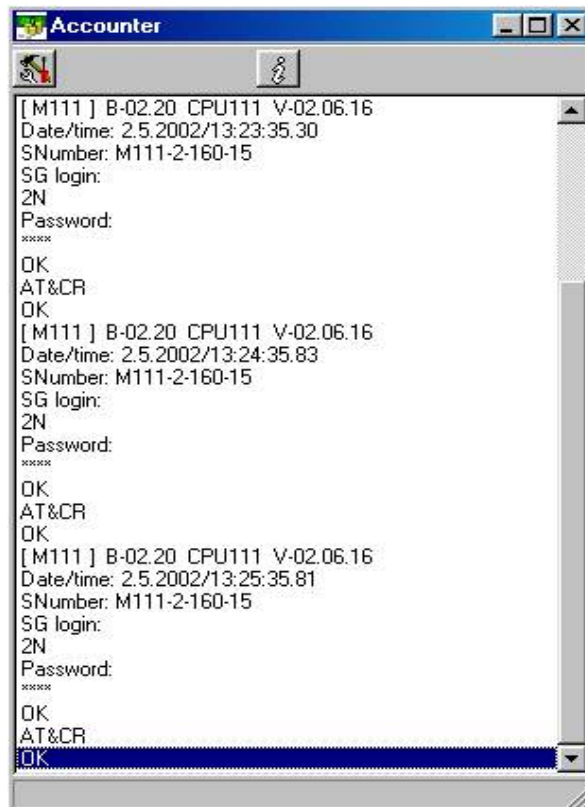

10.4. Set-up Accounter program

By starting Accounter program click on icon  for setting of the program. Here you have options set in individual flags:

- **Starts** – setting of individual times, when the program will automatically save cdr info from PRIGW + selection of the method of saving in the files.
 - **A Time** : 1 time of automatic saving
 - **B Time** : 2. time of automatic saving
 - **C Time** : 3. time of automatic saving
 - **Repeatedly** : Will automatically save cdr each xx minutes (if set for 0, this method is off)
 - **At start program** : Automatic save of cdr by start of the program
 - **Only one file** : If marked, program saves cdr info in one file (Dddmmyy.cdr), if not marked, he differentiate following the method of saving (1 time – file DddmmyyABSx.cdr, 2 time –file DddmmyyB.cdr, 3 time – file DddmmyyCBSX.cdr, Repeatedly – DddmmyyBSx.cdr, At start- file DddmmyyABSx.cdr)
 - **Use** : Activation of this flag
- **List** – number of lines that will be represent in the status window.
- **Login** – Log in name, password.
 - **Name** : Log in name in the BS
 - **Password** : Log in password in the BS
 - **Save pass** : Saving of the log in password foe next start of the program
 - **Login attempts** : Number of trials of the program by automatic log in.

Make sure that user's password and name are identical with n and p which are saved in connecting PRIGW. By invalid n or p the program will ask for valid characteristics.

- **TCP/IP** – Parameters for connecting of the program to the BS
 - **IP** : IP address of connecting BS (enter in the right form ! e.g:192.168.50.2)
 - **Host** : Network name connecting BS (available in higher versions of the firmware - for the present time do not fill out please)
 - **Port** : Number of the remote data port for communication via TELNET (standard 23).
 - **Service** : Title of the protocol – DO NOT FILL OUT !

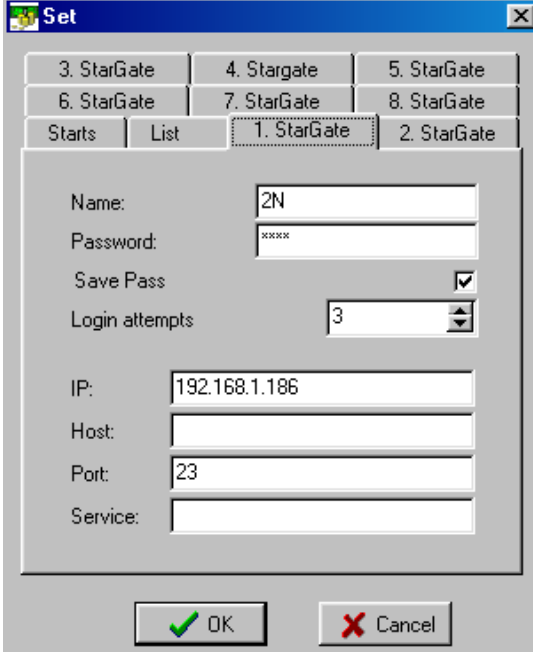

The screenshot shows the 'Set' configuration window. At the top, there is a grid of buttons labeled '3. StarGate', '4. Stargate', '5. StarGate', '6. StarGate', '7. StarGate', and '8. StarGate'. Below this grid are two tabs: 'Starts' and 'List'. Under the 'List' tab, there are two buttons: '1. StarGate' and '2. StarGate'. The main area of the window contains several input fields: 'Name' with the value '2N', 'Password' with 'xxxx', 'Save Pass' with a checked checkbox, 'Login attempts' with a dropdown menu set to '3', 'IP' with '192.168.1.186', 'Host' (empty), 'Port' with '23', and 'Service' (empty). At the bottom right, there are 'OK' and 'Cancel' buttons.

10.5. Settings of the Accounter program

The name of the file in which the program is saving the CDR is derived from actual date (set on PC on which is running) in following form:

DddmmyBSx.cdr (dd – day; mm- month; yy-year; x – no. Of PRIGW unit)

In case you have off option "Only one file" the program is saving this info in more files with deference of the last letter.

E.g. D120202A.cdr is file generated at 12.2.2002 and data were saved via automatic saving in "A.Time" of the time.

Along files with cdr info is program saving it the file "**accounter.log**" info about individual conditions of the program (if the downloading was successful and etc.)

11. Appendix A - AT Commands for Communication

11.1. Basic Commands

11.1.1. System Information

ATI3	Firmware version and copyright
ATI4	Factory number

System status

AT&S	Status of all inserted boards
AT&Spr	Detailed status of PRI ISDN board
AT&Sax	Detailed status of AUX board
AT&Sxx	Detailed status of xx. GSM board (xx=00-7)
AT&S=info	Detailed status of one param. on all boards (info=name of parameter, which you want to show)
AT&U	Status of logged users on all interfaces
AT!Q	Status of memory log buffer
AT&XC	Status of all proceeding calls
AT&XP	Status of all proceeding calls (sorted by number of B-channel)
AT&XG	Status of all proceeding calls (sorted by number GSM module)
AT&M0	Turning off ANSI terminal color usage
AT&M1	Turning on ANSI terminal color usage
AT&M9	Turns on MATRIX (for testing load of transfer connection)

Statistics

AT&T	Statistics of calls via PRI interface
AT&TIN	Statistics of incoming calls via GSM modules
AT&TOUT	Statistics of outgoing calls via GSM modules
AT&T##	Statistics of calls via SIM cards of ##. GSM module
AT%TPR=mi,ci,mo,co	Setting of statistics via PRI
AT%TG0=mi,ci,0,0	Setting of statistics of incom. calls via all GSM modules in GSM group 0
AT%TG#=mi,co,ri,ro	Settings of statistics of GSM group no. #
AT%TGALL=mo,co,ri,ro	Settings of statistics of all GSM groups
AT%T##=#,mi,ci,si,mo,co,so	Settings of statistics of SIM card no. # of GSM module no. ##
AT%T##=ALL,mi,ci,si,mo,co,so	Settings of statistics of all SIM cards of GSM module no. ##
AT%TALL=ALL,mi,ci,si,mo,co,so	Settings of statistics of all SIM cards of all GSM modules
<i>Description of parameters:</i>	Mi/mo > Minutes of incom./outg. calls Ci/co > number of connected incom./outg. Calls Ri/ro > number of re-routed incom./outg. Calls in group Si/so > number of received/sent SMS messages
! When you change these parameters, all another counters will be resets!!	

GSM modules	
AT&Qxx	Received GSM signal level (xx=00-15)
AT&QALL	Received GSM signal level from all GSM modules
AT&Gxx=atcmd	Send command for AT commands directly into GSM module AT&Gxx=at+cnum – SIM card telephone number AT&Gxx=at+cpin="xxxx" – PIN entering AT&Gxx=at+clck="sc",1"xxxx" - PIN request enable AT&Gxx=at+clck="sc",0"xxxx" - PIN request disable

Log file	
AT&L	Log file listing (PRIGW awaits pressing of the Space bar after every 20 lines)
AT&C	Call file listing (PRIGW awaits pressing of any key after every 20 lines)
AT&CR	Call file listing and deleting (PRIGW awaits pressing of the key "#" for delete this line /with info about call/ form memory and send next line)

11.2. Configuration Commands

11.2.1. Status Information

AT&V	Overview of all system settings
AT&VI	Overview of PRI ISDN settings
AT&V0	Overview of basic GSM settings
AT&V#	Overview of #-the GSM group settings (#=1-8)
AT&VALL	Overview of all GSM group settings
AT&N#	Overview of parameters of network list no. # (#=1-8)
AT&NALL	Overview of parameters of all network lists
AT&R	Overview of LCR lines

11.2.2. Default Reset

AT&FRES	Reset with gateway factory settings
--------------------	-------------------------------------

11.2.3. System Settings

AT%S70=x.x.x.x	IP address
AT%S71=x.x.x.x	IP address mask
AT%S81=	Initialization string for setting of mode connected to the gateway COM2
AT%S90=x	Type of assignment of B-channels to GSM modules (0-rotating; 1-locked; 2-according to credit)
AT%S91=x,y	Way of call information recording (0- no record; 1- successfully connected outgoing call; 2- successfully connected incoming calls; 3- successfully connected incoming and outgoing calls; 5- all outgoing calls; 6- all incoming calls; 7- all incoming+outgoing calls) Y = to each call add NET info (1) or no (0)
AT%S93=x	Global selection of SIM card (0= according to

	GSM group, 1-8= number of SIM holder)
AT%S98=xxxx	PIN code for SIM cards inserted in the gateway
AT%S99= dd.mm.yy.w/hh:mm:ss	Gateway date and time settings
AT%X00=hout,hin,min	Automatic logout of GSM modules hout ...hour when the modules start to log out randomly hin ...hour when the modules start to log in randomly min ...minimal number of modules in the group (2..15) which remains always logged in
AT%X80=name/pass	User name/password for access via IP port (this parameter is only write only- you can't see its value)

11.2.4. System control

AT&Bxx=DOWN	Transfer of GSM board No. xx into the sleep mode
AT&BPR=DOWN	Transfer of PRI board into the sleep mode
AT&BALL=DOWN	Transfer of all GSM boards into the sleep mode
AT&Bxx=RESET	Reset of GSM board No. xx
AT&BPR=RESET	Reset of PRI board
AT&BALL=RESET	Reset of all GSM boards
AT&BSYS=RESET	Reset of PRIGW
AT&Gxx=RESET	Reset of GSM module No xx
AT&Gxx=BLOCK	Block of GSM module No xx
AT&Gxx=DOWN	Transfer of GSM module into the sleep mode
AT&Gxx=ON	Transfer of GSM module into the idle mode

11.2.5. ISDN PRI Board Settings

AT%i00=	ISDN PRI port type (TE/S ; TE/M ; NT/S ; NT/M)
AT%i01=x,y	X - TEI ISDN PRI connections (0-63) Y – CRC (0=off, 1=on)
AT%i05=c1,c2,c3,c4	Number of causes sent to PRI ISDN (in the ReleaseComplete) whenever an incoming call from PRI ISDN is rejected.
AT%i11=	MSN for remote control via PRI1
AT%i12=	MSN for remote control via PRI2
AT%i04=x,y	Channel select for PRI 1 / PRI 2
AT%i06=c1,c2,c3,c4	Progress messages
AT%i09=day,bits,edb	Day- day of reset statistics Bits – 0= no dialtone 1=continuous 3=discontinuous

Basic GSM settings

AT%G00=rr,gggggg,gggggg,gg gggg,gggggg,gggggg	g,r=Number of GSM group for each GSM module
AT%G01=mode,atms,atfs	Voice processing settings (for GM22 GSM modules only) mode – algorithm (0-none, 1-semiduplex, 2-fullduplex)

!! Preliminary version of user guide v1.8 !!

	atms,atfs – transit, receive gain (3=+5db, 1=+2.5db, 0=0db, 2=-2.5db, 4=-5d)
AT%G02=mode,atms,atfs	Voice processing settings (for TC35 GSM modules only) mode – algorithm (2-echo canceller) atms,atfs – transit, receive gain (3=+5db, 1=+2.5db, 0=0db, 2=-2.5db, 4=-5d)
AT%G06=mmdd,...mmdd...	List of holiday days (mm-month;dd-day) max length of line is 63 chars!
AT%G07=mmdd,...mmdd	Net list of holiday days
AT%G08=delay,min,max,tout	Parameters of dial from ISDN to GSM delay– relax delay between calls min – minimal length of number dialed from ISDN max – maximal length of number dialed from ISDN tout – delay between dial digits

GSM settings (x-GSM group)

AT%G#0=sim	Mode of switching SIM card sim> 0- OFF – group is turn-off 1-4 – SIM card no. 1-4 5 – switching by time 6 – switching by random time
AT%G#1=netid,clir,min,sms,sec,sec2,pseudo	Basic parameters of SIM card in slot 1 netid-network number clir – 0=default,1=enabled,2=disabled min – maximal number of minutes called sms – maximal number of SMS sent sec – min length of call (no for cdr info) sec2 – accuracy of measurement length of call (no for cdr info) pseudo – default = 0
AT%G#2=netid,clir,min,sms,sec,sec2,pseudo	Basic parameters of SIM card in slot 2
AT%G#3=netid,clir,min,sms,sec,sec2,pseudo	Basic parameters of SIM card in slot 3
AT%G#4=netid,clir,min,sms,sec,sec2,pseudo	Basic parameters of SIM card in slot 4
AT%G#5= from/to[/from,to/w+]	Time intervals for use SIM card in slot 1, one or two intervals (from=to=hh:mm), w+(w-) parameter „w+“ (all weekend) or „w-“, (no weekend) for enabled/disabled SIM on weekends. In case that AT%G#0=6 from/to= min/max limit for generate random time for switch SIM.
AT%G#6= from/to[/from,to/w+]	Time intervals for use SIM card in slot 2
AT%G#7= from/to[/from,to/w+]	Time intervals for use SIM card in slot 3
AT%G#8= from/to[/from,to/w+]	Time intervals for use SIM card in slot 4

List of Networks

AT%N#0=op/np,...op/np	List of prefixes replaced by new prefixes (#-number of netlist; op-old prefix;np-new prefix)
AT%N#1=pr/n,...pr	List of prefix dialed for ISDN (will be use for LCR table)

/n	pr=prefix n=length of number (parameter /n is optional)
AT%N#2..7=pr/n,... pr/n	Next 7 list of prefixes dialed for ISDN
AT%N#9=net,max	Net-network number, max-default length of number dialed from ISDN

LCR	
AT&R	Table of LCR
AT%R##=net,hh:mm/hh:mm/w* ,gr	Settings of line ## (0..63) of LCR table net – number of Network list (0..8) hh:mm/hh:mm/w* – time limitation for use this line gr – GSM group numbers

Commands for Testing via AUX

AT!SPxx=dial	Initiates testing call from AUX interface (xx is the called interface): 1..15, 17-31 B-channel 32-rotaring B-channel
AT!SGxx=dial	Initiates testing call from AUX interface (xx is the called interface): 00..31 GSM module 32- to GSM via GSM module according to call prefix
AT!WPxx	Connects the following call from interface xx to interface AUX. 1..15, 17-31 from B-channel no. 32 first incoming call from ISDN
AT!WGxx	Connects the following call from interface xx to interface AUX. 00..31 from GSM no. 32 first incoming call from GSM
AT!D	Terminates call on AUX interface

Commands for Tracing*

AT!RE	Start tracing of error messages active interface.
AT!Lx	Start tracing of LAN & Telnet on layer x x=2 – Layers IP,TCP,Telnet x=3 – Layers TCP, Telnet x=4 – Layer Telnet
AT!Rx	Start tracing of ISDN PRI & GSM on layer x x=1 – Layers 1,2,3,4 x=2 – Layers 2,3,4 x=3 – Layers 3,4 x=4 – Layer 4
AT!RR	Start tracing (AT!R2) to COM1 interface
AT!RX	Stop tracing (AT!R2) to COM1 interface

* Tracing can run only via one port !!

Commands for sending and receiving SMS messages

AT!G=A6	Start low-level controlling for SMS messages (can run only on one port)
AT!G=55	Stop low-level controlling on used port
	Controlling SMS messages
AT^SX=ch	...(sms listing) request to list of all SMS messages and

	status confirmations saved on SIM card. Possible answers:: *smserr (busy,list) or *smsinc (ix=1..255) for each saved SMS or status SMS , end of list or empty SIM card - *smsinc (ix=0).
AT^SR=ch,ix	...(sms read) request to read SMS message or SMS status saved on SIM card. Possible answers: *smserr (busy,read) or *smspdu
AT^SD=ch,ix	...(sms delete) request to delete SMS message (or SMS status message). Possible answers: *smserr (busy,delete) or *smsdel
AT^SM=ch,len,pdu,csum	...(sms to module) request to send message via GSM module 0..31 or via any GSM module (ch=32). Possible answers: *smserr (busy, write) or *smsout
AT^SG=grp,len,pdu,csum	...(sms to group) request to send SMS message via GSM group 1..8. Possible answers: *smserr (busy, write) or *smsout
	Messages from PRIGW unit
*smsinc: ch,ix,sts	... SMS message was received and saved to SIM card: <ul style="list-style-type: none"> • Ch ...GSM module number 0..31 • Ix ...index number of saved SMS messages 0..255 • Sts ...status of SMS message
*smsrep: ch,ix	...SMS status confirmation was received and saved to SIM card (this message is only for GSM modules TC35 and GM47)
*smsout: ch,ix,ref	...SMS message was sent and didn't saved to SIM card: Ref ...reference number of sent SMS 0..255 (will be used in SMS status confirmation message)
*smspdu: ch,ix,sts,len,pdu,csum	...content of SMS message from status confirmation: <ul style="list-style-type: none"> • Len ...length of SMS message (number of bytes in pdu) • Pdu ...content message in PDU format • Csum ...Checksum of all PDU bytes (2 hexa digits) calculated without carry
*smsdel: ch,ix	SMS message or status confirmation was deleted from position ix
*smserr: ch,ix,req,err	response to error command: <ul style="list-style-type: none"> • Req ...required GSM module or GSM group • Err ...error code (6=busy, 40=write, 41=read, 42=delete, 43=list)

12. APPENDIX B – LIST OF ALL STATUS CODES

12.1.1. Plug-In Boards

<i>Board Types</i>		
ID	Name	Description
0	NONE	(no board)
1	CPU111	(CPU board is not displayed)
2	PRI130	1x PRI port NT/TE
3	GSM160	2x GSM Ericsson GM22 module + 2x SIM
4	AUX120	Switch matrix, voice message generator and AUX port
5	GSM161	2x GSM Siemens TC35 module + 8x SIM

<i>Board Types</i>			
ID	Name	Description	What Follows
0	INIT	HW board reset and init of respective SW parts in progress	OK/CHECK
1	ERROR	Board in wrong slot or defective board HW	board reset
2	POWER	Only upon system power on or AT!Bxx=RESET command	DETECT
3	OK	Rest status, HW is working on board (full operation)	DISC
4	UNDEF	Empty slot	DETECT
5	CHECK	Board firmware check (AUX only)	ERASE
6	ERASE	Board firmware erasing (AUX only)	PROF
7	PROG	New board firmware loading (AUX only)	OK
8	DETECT	New board plug-in detected	INIT
9	DOWN	Frozen status, HW is working on board but no new calls are started	board reset
10	MODEM0	Parameter S80 sent to modem (AUX only)	MODEM1
11	MODEM1	Parameter S81 sent to modem (AUX only)	OK
12	DISC	Board plug-out detected	UNDEF

12.1.2. ISDN Layer Statuses

<i>ISDN Layer 1 Statuses</i>		
ID	Name	Description
0	DEACT	Deactivation – no signal received
1	ACTIVE	Activation – full synchronization achieved (frame,multiframe,crc)
2	SIGNAL	Signal received – no synchronization
3	SYNC	Signal received – only partial synchronization (frame)

ID	Name	Name According to Q.921
0	NOTEI	TEI Unassigned
1	AWTEI	Assigned Awaiting TEI
2	AWTEST	Establish Awaiting TEI
3	OKTEI	TEI Assigned
4	AWEST	Awaiting Establishment
5	AWREL	Awaiting Release
6	OKEST	Multiple Frame Established
7	TIMREC	Timer Recovery

ISDN Layer 3 Statuses				
ID	Name	Name According to Q.931	NT Description	TE Description
0	NULL	Null	Rest status, ready for call	
1	CINIT	Call Initiated	Call from PRI indicated	Call to PRI started
2	OVSEND	Overlap Sending	Gradual dialing receiving	Gradual dialing sending
3	OPROC	Outgoing Call Proceeding	Dialing from PRI terminated	Dialing to PRI terminated
4	CDELIV	Call Delivered	Call from PRI ringing	Call to PRI ringing
6	CPRES	Call Present	Call to PRI started	Call from PRI indicated
7	CRECV	Call Received	Call to PRI ringing	Call from PRI ringing
8	CONREQ	Connect Request	Call to PRI answered	Call from PRI answered
9	IPROC	Incoming Call Proceeding	Dialing to PRI terminated	Dialing from PRI terminated
10	ACTIVE	Active	Connected call	
11	DISREQ	Disconnect Request	End of call from PRI	End of call to PRI
12	DISIND	Disconnect Indication	End of call to PRI	End of call from PRI
19	RELREQ	Release Request	Channel release request	
25	OVRECV	Overlap Receiving	Gradual dialing sending	Gradual dialing receiving
61	RSTREQ	Restart Request	Channel restart request sent	
62	RSTART	Restart	Channel restart request received	

ISDN Layer Management Statuses		
ID	Name	Description
0	INIT	Initialization upon PRI board reset
1	IDLE	Activation – rest status, necessary for layers 2 and 3
2	DISC	Deactivation

12.1.3. GSM Layer Statuses

GSM Layer 2 Statuses			
ID	Name	Description	What Follows
0	INIT	GSM module initialization start	PINREQ
1	SIM0	Module switch to internal SIM card	INIT
2	PINREQ	Module PIN request	PINSET
3	PINSET	PIN value sensing to module	INFO
4	BLOCK	Module blocked temporarily or permanently (see Layer 2 information)	INIT
5	SETUP	Module configuration running	IDLE
6	SLEEP	Module sleep running (transition to BLOCK status)	BLOCK
7	NWAIT	Awaiting GSM log-in	SETUP
8	IDLE	Rest status, can start/receive call, execute AT&G command	CALL/CMD
9	CALL	Call running (call establishing, connected call, call end)	IDLE
10	CMD	Communicating with module upon AT&G command	IDLE
13	INFO	Information loading from module and SIM card	NWAIT

GSM Layer 2 Info for BLOCK Status

ID	Name	Description
41	(block)	Blocked by AT&G command, terminated by module, board or system reset
42	Netw-reg	GSM log-in refused (not activated SIM), next attempt in 5..60 minutes
43	Clir-err	CLIR activation request refused, next attempt in 2..10 minutes
44	Mod-err	Defective or not connected GSM module, next attempt in 2 minutes
45	Pin-err	Wrong PIN, permanently in BLOCK status
46	Sim-err	Defective or not inserted SIM card, next attempt in 2 minutes
47	Log-out	Temporarily logged-out according to parameter X00
48	Puk-req	SIM card requires PUK
	(undef)	This position of SIM card wasn't checked by gateway

<i>GSM Layer 3 Statuses</i>		
ID	Name	Description
0	NULL	Rest status, ready for call
1	CINIT	Request of call to GSM (from Layer 4)
3	OPROC	Call to GSM is connected
4	CDELIV	Call to GSM is ringing
6	CPRES	Indication of call from GSM (from Layer 2)
7	CRECV	Call from GSM is ringing on ISDN interface
9	IPROC	Call from GSM is processed by ISDN interface
10	ACTIVE	Connected call
11	DISREQ	Disconnection request (to Layer 2)
12	DISIND	Indication of disconnection (from Layer 2)
19	RELREQ	Module release for another call (to Layer 2)
25	OVRECV	Reading of DTMF dialing from GSM (from Layer 2)
38	RELIND	Indication of module release (from Layer2)

12.1.4. Link Layer Statuses

<i>Layer 4 Statuses</i>		
ID	Name	Description
0	NULL	Rest status, ready for call
1	MORE	Call request received from GSM or ISDN, awaiting further dialing or timeout
2	SETUP	Call request sent to opposite interface
3	PROC	Call request confirmed, awaiting call answer
4	ACTIVE	Connected call
5	DISC	Call disconnection in progress

12.1.5. Command Shell Statuses

Command Shell Statuses

ID	Name	Description
0	IDLE	Rest status, awaiting AT commands
1	REQUEST	Communication with GSM module upon AT&G command is displayed
2	REPORT	Active tracing
3	LOGFILE	Content of log file is being written out
4	CALLFILE	Content of call file is being written out
5	CALLREAD	Call file records are read
6	AUTOFILE	Content of incoming call autorouting chart is being written out
7	QUERY	(not used so far)
8	SCREEN	(not used so far)
9	MATRIX	Active matrix screensaver
10	FUNCFILE	Content of debug file is being written out
11	LCRFILE	(not used so far)

Telnet Layer Statuses

ID	Name	Description
0	LOGOUT	User logged-out
1	LOGIN	User is entering name
2	PASSW	User is entering password
3	IDLE	User logged-in

12.1.6. Records of Events and Calls

Record Type in Log File

ID	Name	Description
0	POWER	System power on, power off or reset
1	INIT	Initialization of EEPROM (configuration) or flash (upgrade)
2	HW-ERR	HW error of plugged-in board
3	SYSERR	System error (memory error, etc.)
4	BRDIN	Board plugged-in
5	BRDOUT	Board plugged-out
6	BRDRES	Board reset using AT!B command
8	L1-ERR	PRI port layer 1 error (ISDN1)
9	L2-ERR	PRI port layer 2 error (ISDN2)
10	L3-ERR	PRI port layer 3 error (ISDN3)
12	G2-ERR	GSM module layer 2 error (gate2)
13	G3-ERR	GSM module layer 3 error (gate3)
14	C4-ERR	Link layer error (call4)

Record Type in Call File

ID	Name	Description
0	I-FD	Not connected incoming call attempt
1	I-OK	Connected incoming call
8	O-FD	Not connected outgoing call attempt
9	O-OK	Connected outgoing call

12.2. Abbreviations in Tracing

12.2.1. Identification of Channels and Processes

With tracing activated, internal system messages (transmitted between processes), messages received on and sent to the PRI port, and AT commands and replies sent to GSM modules are written out. The listing of a message related to a specific call starts with the B-channel and GSM module numbers and an arrow showing the message direction. A right arrow (→) means a message received on the interface (PRI, GSM, LAN) or a message directed from the process of a lower layer to the process of a higher layer (indication, confirmation). A left arrow (←) designates a message sent to the interface (PRI, GSM, LAN) or a message directed from the process of a lower layer to the process of a lower layer (request, response). The message type (layer 3 messages are shifted by a space to the right, layer 4 messages by two spaces to the right) and the message content follow.

12.2.2. ISDN Messages

Typically Used ISDN Messages (Q.931)

000h	!alertin	Alerting	04Dh	!release	Release
001h	!callproc	Call proceeding	04Eh	!restack	Restart acknowledge
002h	!progress	Progress	05Ah	!relcompl	Release complete
003h	!setup	Setup	062h	!facility	Facility
005h	!connect	Connect	06Eh	!notify	Notify
007h	!setack	Setup acknowledge	075h	!stsensq	Status enquiry
00Dh	!connack	Connect acknowledge	07Bh	!info	Information
00Fh	!disconn	Disconnect	07Dh	!status	Status
046h	!restart	Restart			

Typically Used ISDN Elements (Q.931)

004h	BEA	Bearer capability	04Ch	CTN	Connected party number
008h	CAU	Cause	04Dh	CTS	Connected party subaddress
010h	CID	Call identity	06Ch	CGN	Calling party number
014h	CST	Call state	06Dh	CGS	Calling party subaddress
018h	CHA	Channel identification	070h	CDN	Called party number
01Ch	FAC	Facility	071h	CDS	Called party subaddress
01Eh	PRG	Progress indicator	079h	RST	Restart indicator
020h	NTW	Network-spec facility	07Ch	LCO	Low layer compatibility
027h	NOT	Notification indicator	07Dh	HCO	High layer compatibility
028h	DSP	Display	07Eh	USR	User-user
029h	DAT	Date/time	07Fh	ESC	Escape for extension
02Ch	KEY	Keypad facility	0A1h	SEC	Sending complete

Typically Used ISDN Elements - Cause (Q.850)		
ID	Name	Whole Name
1	Unassnumb	Unassigned number
6	Unaccchan	Channel unacceptable
16	Clear	Normal call clearing
17	Userbusy	User busy
21	Reject	Call rejected
27	Destout	Destination out of order
28	Invformat	Invalid number format
30	Stsenqresp	Response to StatusEnquiry
31	Normal	Normal, unspecified
34	Noanychan	No channel available
41	Tempfail	Temporary failure
42	Swcongest	Switching equipment congestion
44	Noreqchan	Requested channel not available
65	Nobearer	Bearer capability not implemented
81	Callref	Invalid call reference value
88	Dest	Incompatible destination
96	Elemmiss	Mandatory information element is missing
97	Message	Message type non-existent or not implemented
99	Element	Information element / parameter non-existent or not implemented
100	Elemerror	Invalid information element contents
101	Incness	Message not compatible with call state
102	Timeout	Recovery on timer expiry
127	Undefined	Interworking, unspecified

12.2.3. LOG File events

Type	Text	Description
POWER	[Power on]	System switched on
	[Power off]	System switched off
	[Warm boot]	Restart of system, unknown cause
	[Watchdog]	Restart of system by watchdog
	[BKPT code]	CPU error: break code detected
	[Stack error]	CPU error: stock integrity failure
	[Divided by zero]	CPU error: dividing by zero
	[RETI code]	CPU error: illegal using of instruction reti
	[NMI intr]	CPU error: wrong interrupt
	[VOID intr]	CPU error: wrong interrupt
	[Upgrade reset]	Start of upgrade firmware procedure
	[Software reset]	Reset by AT commands (at&fres...)
INIT	Eeprom	Initialization of eeprom (configuration)
	Flash	Initialization of flash memory (firmware)
HW-ERR		(##...address of chip, RD...read value WR...expected value)
	Codec ##,RD/WR	Error in initialization of codec on GSM,AUX board
	COM2 #####,RD/WR	Error in initialization of COM2 on AUX board
	Duart #####,RD/WR	Error in initialization of serial controller on GSM board
	Hscx #####,RD/WR	Error in initialization od HDLC controller on AUX board
	Pri #####,RD/WR	Error in initialization od PRI controller
SYSERR	User stack error!	SW error: stock integrity failure
BRDIN	#08 TYP STS	the board inserted (number of gsm board, type, status)
BRDOU T	#08 TYP STS	the board disconnected
BRDRES	#08 TYP STS	Reset the board by AT command
	ALL GSM RESET CMD	Reset of all GSM boards by AT command
	SYSTEM RESET CMD	Reset of system by command at&bsys
L1-ERR		(reserved)
L2-ERR		Error of 2. ISDN layer by Q.921
	A: unsol.RX(F)	Received packed RR,RNR,REJ with unexpected bit F=1
	B: unsol.DM(F)	Received packed DM with unexpected bit F=1
	C: unsol.UA(F)	Received packed UA with unexpected bit F=1
	D: unsol.UA(-)	Received packed UA with unexpected bit F=0
	E: unsol.DM(-)	Received packed DM with unexpected bit F=0
	F: peer re-est	Received packed SABME in status OKEST
	G: repeated SABME	Repeated unsuccessful send of packet SABME
	H: repeated DM	Repeated unsuccessful send of packet DM
	I: failed (TIMREC)	Unsuccessful breaking-up of status TIMREC
	J: N(R) error	Received wrong value N(R) – numbering of packets
	K: recv.FRMR	Received packed FRMR (information about error)
	L: undef.frame	Received unknown type packed
	M: (l field)	Received wrong l-packet (numbered packet)
	N: frame size	Received packed with wrong length
	O: N201 error	Value N201 was exceeded (max. length of packet)
L3-ERR	tout sts # (p##)	Error of 3. layer isdn: timeout in status # on channel p##
G2-ERR	ATD/ERROR init (g##)	Error of 2. layer isdn: restart of module g## after rejected command ATD by GSM network
	GSM Cause 150 (g##)	Error of 2. layer isdn: restart of module g## after cause 150 was received (call barred by GSM network)
G3-ERR	tout sts # (g##)	Error of 3. layer isdn: timeout in status # on module g##
C4-ERR	tout sts # (p##/g##)	Error of 4. connecting layer: timeout in status # on call between channel p## and GSM module g##

13. Appendix C - Description of cdr line

Example of successfully connected call:

```
** 31.07.02/11:07:53 O-OK CAU-016 aux/g02 GRP-1 0:23 001:40 00000.00 1
0608218005 45456060 1/8942019636000065750
```

- **1. column:** **
- **2. column:** date/time of start the call
- **3. column:** type of call
 - I-FD : Unconnected attempt of incoming call (It will be implemented at higher version of the firmware)
 - I-OK : Successfully connected incoming call (It will be implemented at higher version of the firmware)
 - O-FD : Unconnected attempt of outgoing call
 - O-OK : Successfully connected outgoing call
- **4. column:** CAUSE sent to ISDN
- **5. column:** number of used B-channel/number of used GSM module
- **6. column:** used GSM group (C= callback to PRI 1 , E= call via PRI 2 interface)
- **7. column:** time of establishing call
- **8. column:** duration of call mmm:ss (max. 255:59) or error cause for unconnected calls
- **8. column:** cost of call (will be implemented in higher version of firmware)
- **9. column :** id of the gateway (optional)
- **10. column:** called number
- **11. column:** caller number
- **12. column:** number of slot/IMSI* of used SIM card

14. Appendix D - Description of statistics

[Statistic of calls on PRI and in groups]

pri/grp (reset)	minutes	hhhh:mm:ss	calls	reject	failed	c.off	errors
#pr out (1.03)	1303	21:43:07	521	1	24	147	2
#pr inc (1.03)	41	0:41:28	24	0	6	1	0

[Statistic of calls on PRI and in groups]

gsm (reset)	minutes	hhhh:mm:ss	calls	reject	failed	c.off	errors
#i1 inc (31.12)	0	0:00:00	0	0	0	0	0
#i2 inc (31.12)	0	0:00:00	0	0	0	0	0
#i3 inc (31.12)	0	0:00:00	0	0	0	0	0
#i4 inc (31.12)	0	0:00:00	0	0	0	0	0
gsm (reset)	minutes	hhhh:mm:ss	calls	reject	failed	red.in	redout
#g1 out (31.12)	0	0:00:00	0	0	0	0	0
#g2 out (31.12)	0	0:00:00	0	0	0	0	0
#g3 out (31.12)	0	0:00:00	0	0	0	0	0
#g4 out (31.12)	0	0:00:00	0	0	0	0	0
#g5 out (31.12)	0	0:00:00	0	0	0	0	0
#g6 out (31.12)	0	0:00:00	0	0	0	0	0
#g7 out (31.12)	0	0:00:00	0	0	0	0	0

#g8 out (31.12) 0 0:00:00 0 0 0 0 0

[Statistic of incoming calls on all modules]

modules	brd	minutes	hhhh:mm:ss	calls	smSES	minutes	hhhh:mm:ss	calls	smSES
#00 #01	00	0	0:00:00	0	0	0	0:00:00	0	0
#02 #03	01	0	0:00:44	1	0	16	0:16:37	10	0
#04 #05	02	14	0:14:15	7	0	5	0:05:31	3	0
#06 #07	03	4	0:04:21	3	0	0	0:00:00	0	0
#08 #09	04	0	0:00:00	0	0	0	0:00:00	0	0
#10 #11	05	0	0:00:00	0	0	0	0:00:00	0	0
#12 #13	06	0	0:00:00	0	0	0	0:00:00	0	0

*each line is for two GSM modules

[Statistic of calls on GSM module #0]

sim/dir	net/grp	minutes	hhhh:mm:ss	calls	reject	failed	c.offS	smSES
#1	inc /1	14	0:14:15	7	0	2	9	0
#2	inc /1	0	0:00:00	0	0	0	0	0
#3	inc /1	0	0:00:00	0	0	0	0	0
#4	inc /1	0	0:00:00	0	0	0	0	0
#1	out /1	439	7:19:51	177	0	6	44	0
#2	out /1	0	0:00:00	0	0	0	0	0
#3	out /1	0	0:00:00	0	0	0	0	0
#4	out /1	0	0:00:00	0	0	0	0	0

- Pri/grp : type of calls
- Reset : Date of last reset the statistics
- Minutes : Number of minutes
- Hhhh:mm:ss : Same number converted to time
- Calls : Number of calls
- SMSES : Number of sent SMS messages
- Reject: number of unconnected calls (no available any free GSM module-call rejected with cause 41(42))
- Failed: number of unconnected calls (rejected by GSM network)
- C.offS: number of unconnected calls (terminated by calling party)
- Errors: number of unconnected calls (wrong requests - disallowed prefix etc.)
- Red.in: number of connected calls (rerouted to this GSM group)
- Redout: number of connected calls (rerouted to another GSM group)

15. Appendix D - Technical Conditions for Installation

15.1. StarGate

15.1.1. Subrack

Dimensions (W x H x D)	482 x 133 x 360 mm (84HP x 3U x 360 mm)
Weight (full configuration)	9,800 g
Power supply	100-240V AC / 50-60Hz
Power input	max. 230VA

15.1.2. GSM

Mobile network type	GSM phase II or UMTS
Transmission output per channel	900MHz / 2W, 1800MHz / 1W or 850MHz / 2W, 1900MHz / 1W or 850MHz / 1900MHz / 2100MHz
SIM cards	plug-in small 3V
VF connector	GSM boards with TC35i,MC45(6),GM47(8), Q25CL UMTS boards with MC8755V modules –SMA 50ohm
Length of antenna cable (RG58)	Max. 20m

15.1.3. PRI Interface(s)

Interface	ISDN PRI
Signaling	Q.931-EDSS1
Type (NT or TE)	NT/TE
TEI number	0 – 63
Clock (master or slave)	Master/Slave
Connector RJ 45, Rxpin, Txpin	Switchable RJ45 (Rx-3,6 Tx-4,5 / Rx-4,5 Tx-3,6)
D channel timeslot	16

15.1.4. VoIP interface

Interface	4x 100BaseT
Signaling	SIP
Voice compression	G.723.1 MP-MLQ at 6.3, ACELP at 5.3 kbps G.729 Annex A CS-ACELP at 8kbps G.727 E-ADPCM at 16 to 40 kbps G.726 ADPCM at 16 to 40 kbps G.711 PCM at 64kbps (u-Law/A-Law) NetCoder Proprietary at 6,4 to 9,6 kbps, 800 bps steps
Silence suppression	G.723.1 Annex A ; G.729 Annex B PCM and ADPCM – per RFC 3389 or proprietary

	NetCoded – Proprietary
Echo Cancellation	G.165 & G.168 compilant, 32,64 or 128 msec echo tail, (64 ms or 128 ms may reduce channel capacities)
CLIR/CLIP	Outgoing calls to GSM
Number of channels	30
Connector type	4x RJ45 (Ethernet switch)

15.1.5. Temperature

Working temperature range	0°C to + 50°C
Relative humidity	max. 95% at 40°C
Air – condition	optional

15.1.6. Remote Control Line types

Type of line	Serial line (COM1,2), Analog modem (COM2), ISDN modem (COM2), Ethernet 10baseT
--------------	--

15.2. BlueStar

15.2.1. Subrack

Dimensions (W x H x D)	482 x 133 x 360 mm (84HP x 3U x 360 mm)
Weight (full configuration)	9,000 g
Power supply	100-240V AC / 50-60Hz
Power input	max. 230VA

15.2.2. GSM

Mobile network type	GSM phase II or UMTS
Transmission output per channel	900MHz / 2W, 1800MHz / 1W or 850MHz / 2W, 1900MHz / 1W or 850MHz / 1900MHz / 2100MHz
SIM cards	plug-in small 3V
VF connector	GSM boards with TC35i,MC45(6),GM47(8), Q25CL UMTS boards with MC8755V modules –SMA 50ohm
Length of antenna cable (RG58)	Max. 20m

15.2.3. PRI Interface

Interface	1x or 2x ISDN PRI
Signaling	Q.931-EDSS1,
Type (NT or TE)	NT/TE
TEI number	0 – 63
Clock (master or slave)	Master/Slave
Connector RJ 45, Rxpin, Txpin	2x Switchable RJ45 (Rx-3,6 Tx-4,5 / Rx-4,5 Tx-3,6)
D channel timeslot	16

15.2.4. VoIP interface

Interface	4x 100BaseT
Signaling	SIP
Voice compression	G.723.1 MP-MLQ at 6.3, ACELP at 5.3 kbps G.729 Annex A CS-ACELP at 8kbps G.727 E-ADPCM at 16 to 40 kbps G.726 ADPCM at 16 to 40 kbps G.711 PCM at 64kbps (u-Law/A-Law) NetCoder Proprietary at 6,4 to 9,6 kbps, 800 bps steps
Silence suppression	G.723.1 Annex A ; G.729 Annex B PCM and ADPCM – per RFC 3389 or proprietary NetCoded – Proprietary
Echo Cancellation	G.165 & G.168 compliant, 32,64 or 128 msec echo tail, (64 ms or 128 ms may reduce channel capacities)
Number of channels	16
Connector type	4x RJ45 (Ethernet switch)

15.2.5. Temperature

Working temperature range	0°C to + 50°C
Relative humidity	max. 95% at 40°C
Air – condition	optional

15.2.6. Remote Control Line types

Type of line	Serial line (COM1,2), Analogue modem (COM2), ISDN modem (COM2), Ethernet 10baseT, in band DATA in PRI ISDN
--------------	--

15.3. BlueTower

15.3.1. Subrack

Dimensions (W x H x D)	160x185x320mm (29HPx3Ux320mm)
Weight (full configuration)	4,1 kg
Power supply	100-240V AC / 50-60Hz
Power input	max. 50VA

15.3.2. GSM

Mobile network type	GSM phase II or UMTS
Transmission output per channel	900MHz / 2W, 1800MHz / 1W or 850MHz / 2W, 1900MHz / 1W or 850MHz / 1900MHz / 2100MHz
SIM cards	plug-in small 3V
VF connector	GSM boards with TC35i,MC45(6),GM47(8), Q25CL UMTS boards with MC8755V modules –SMA 50ohm
Length of antenna cable (RG58)	Max. 20m

15.3.3. PRI Interface

Interface	1x or 2x ISDN PRI
Signaling	Q.931-EDSS1
Type (NT or TE)	NT/TE
TEI number	0 – 63
Clock (master or slave)	Master/Slave
Connector RJ 45, Rxpin, Txpin	2x Switchable RJ45 (Rx-3,6 Tx-4,5 / Rx-4,5 Tx-3,6)
D channel timeslot	16

15.3.4. Temperature

Working temperature range	0°C to + 50°C
Relative humidity	max. 95% at 40°C
Air – condition	optional

15.3.5. Remote Control Line types

Type of line	Serial line (COM1,2), Analogue modem (COM2), ISDN modem (COM2), Ethernet 10baseT, in band DATA in PRI ISDN
--------------	--

Use the product as designed and manufactured and in accordance with these instructions for use.

The manufacturer reserves the right to modify the product in order to improve its qualities.

2N StarGate / BlueStar / BlueTower contains no environmentally harmful components. When the product's service life is exhausted and you find no other application for it, dispose of it in accordance with applicable legal regulations.